

A-S2100

Integrated Amplifier



A Living Tradition in Sound

A piano comes into this world through the perfect synergy of advanced technical skill and artistry. Such a piano can create sound that truly reflects the player's feelings.

The final stage in piano production is called "voicing". It is here that the instrument is given its soul.

A highly skilled expert concentrates his mind and sensitivity on the sound of each key, finely adjusting the dynamic feel of the hammers, bringing the tone and vibrancy of all 88 keys together perfectly; a truly stunning achievement.

It is a quality of sound that can only be determined by an astute, sensitive ear. We apply this very same concept to the manufacture of our audio products. The technician performs exhaustive listening tests and every component is considered, in order to finally achieve the ideal sound.

Yamaha's tradition of audio quality stretches back over 125 years, and continues to live on in all Yamaha products today.



Excellence in Audio Achievement

1920-
1960s

First HiFi System introduced in 1920

We introduced numerous HiFi components (turntables, FM/AM tuners, integrated amplifiers, preamplifiers, power amplifiers and speakers) in 1955 - 1965.

Natural Sound Speaker Series introduced in 1967

NS-20 Monitor Speaker



NS-20



CA-1000

1970s

CA-1000 Integrated Amplifier

Featuring A-Class operation, the CA-1000 set the standard for integrated amplifiers.

NS-690 Natural Sound Speaker



NS-690



NS-1000M

NS-690M Monitor Speaker

A truly legendary speaker still revered by HiFi enthusiasts.

B-1 Power Amplifier

An innovative power amp that used vertical FETs in all stages.

C-2 Control Amplifier

Received top prize at the Milan International Music and HiFi Show.

NS-10M Studio Monitor Speaker

Became of the most popular studio monitors in the world.

A-1 Integrated Amplifier

PX-2 Turntable

Yamaha's first straight arm turntable.



B-1



C-2



PX-2



NS-10M



B-6



A-1

1980s

B-6 Power Amplifier

Pyramid-shaped power amplifier.

GT-2000/L Turntable

First CD Player (CD-1) introduced in 1983

B-2x Power Amplifier

**MX-10000 Power Amplifier and
CX-10000 Control Amplifier**

Redefined the capabilities of separate components.

AX-1 Integrated Amplifier



MX-10000



B-2x



CX-10000



NP-S2000

1990s

GT-CD1 CD Player

**MX-1 Power Amplifier and
CX-1 Preamplifier**

2000s

**Soavo-1 and Soavo-2 Natural Sound
Speaker Systems**

**A-S2000 Integrated Amplifier and
CD-S2000 CD Player**

2010s

NP-S2000 Network Player

**A-S3000 Integrated Amplifier and
CD-S3000 CD Player**



Soavo-1



A-S3000



CD-S3000

A-S2100

◆ *Full floating and balanced circuit design achieves the full potential of analogue amplification*

An entirely new floating and balanced power amplifier achieves complete symmetry and permits full balanced transmission (amplification) from the input jack to just before the speaker jack.

◆ *Full-stage balanced signal transmission*

The integrated amplifier offers full stage balanced transmission, combining high power output with good sound texture and outstanding S/N performance.

◆ *Parallel volume and tone control*

◆ *Large power supply with four separate circuits*

◆ *Left-right symmetrical design with rigid, stable construction*

◆ *Discrete phono amplifier*

◆ *High-quality headphone amplifier with low-impedance drive*

■ **Supplied accessories**

Please check that you have received all of the following parts.

- Remote control
- Batteries (AAA, R03, UM-4) (×2)
- Power cable
- SAFETY BROCHURE

Contents

Controls and functions	6
Connections	16
Specifications	24
Troubleshooting	28

■ **About this manual**

- ✨ indicates a tip for your operation.
- Photographs and illustrations are for explanatory purposes, and may differ from the actual unit.
- Read the “SAFETY BROCHURE” before using this unit.

Controls and functions

In this chapter, you will learn the controls and functions of A-S2100.

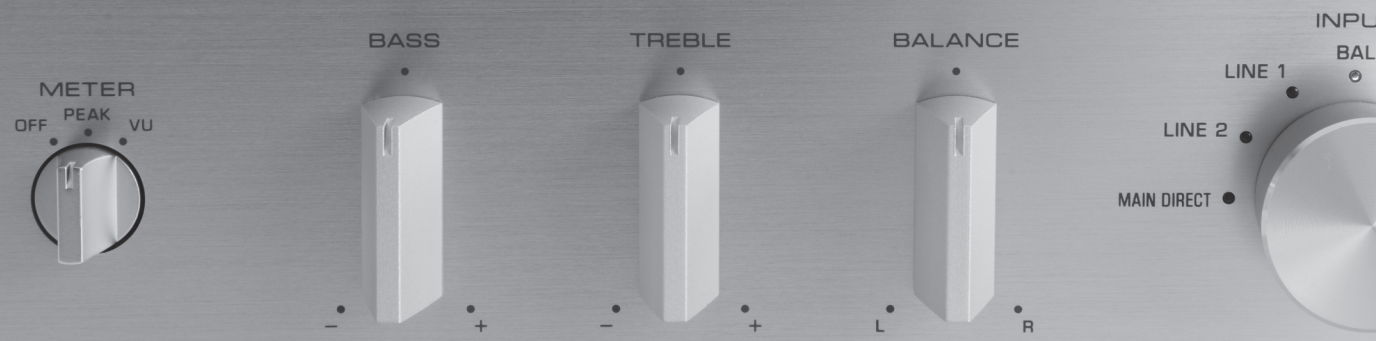
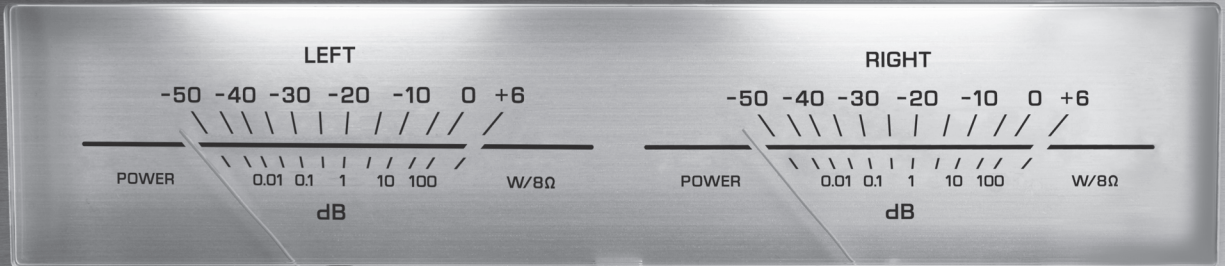

Controls and functions

■ Front panel (pages 6 to 9)

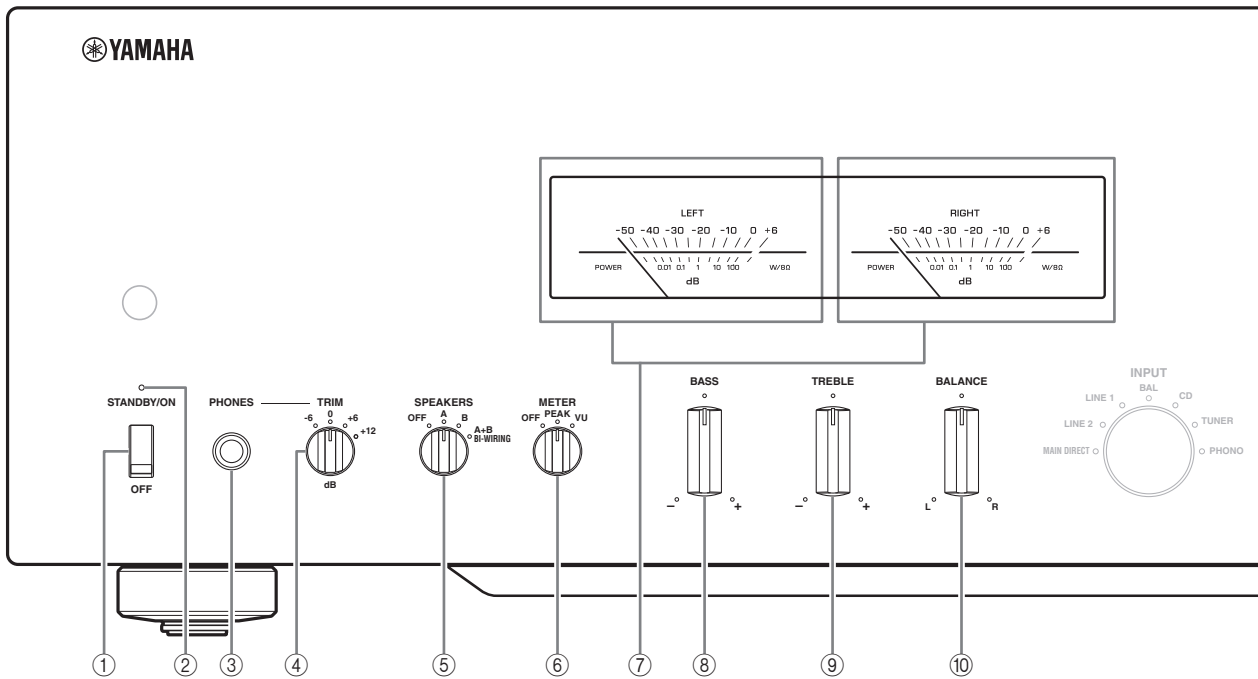

① STANDBY/ON, OFF switch

Turns on or off this unit.

STANDBY/ON (upper position): In this position, you can select STANDBY or ON, using the AMP key on the remote control.

OFF (lower position): The power of this unit is turned off.

Notes

- When you turn on this unit, it will take a few seconds before this unit can reproduce sound.
- If you disconnect the power cable from the AC outlet and connect it again when this unit is in STANDBY mode, the power of the unit is turned on. If the unit is not to be operated for a long time, set the STANDBY/ON, OFF switch to OFF.

② STANDBY/ON indicator

Lit brightly: Shows that the power of the unit is ON. In this condition, you can switch the unit to STANDBY mode by pressing the AMP key on the remote control.

Lit dimly: Shows that the unit is in STANDBY mode. In this condition, you can switch the unit on by pressing the AMP key on the remote control.

Off: Shows that the power of the unit is OFF. In this condition, you can turn the power on only by pressing the STANDBY/ON, OFF switch on the front panel.

③ PHONES jack

Outputs audio for private listening with headphones.

Notes

- When headphones are plugged in:
 - Both speaker sets connected to the SPEAKERS L/R CH terminals are turned off.
 - No signals are output at the PRE OUT jacks.
 - You cannot select MAIN DIRECT as the input source.
- If headphones are plugged into the PHONES jack while MAIN DIRECT is selected as the input source, no audio is output at the PHONES jack.

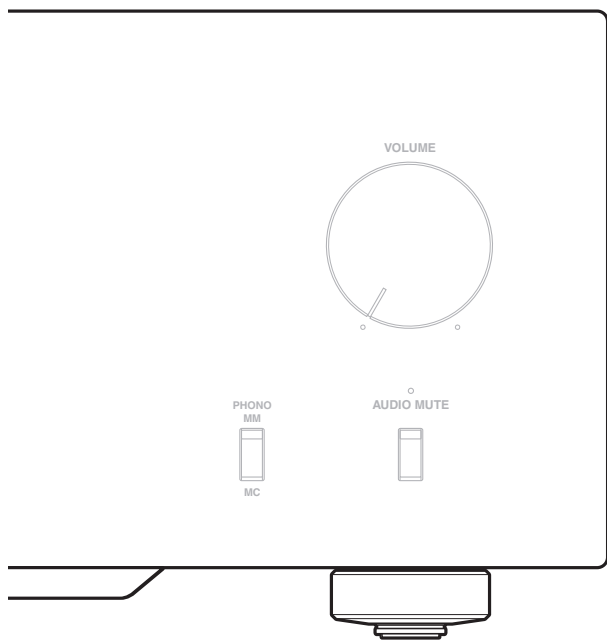

④ **TRIM selector**

Adjusts the volume level when headphones are plugged in to avoid sudden changes in volume.

Choices: -6 dB, 0 dB, +6 dB, +12 dB

⑤ **SPEAKERS selector**

Turns on or off the sets of speakers connected to the SPEAKERS L/R CH A and/or B terminals on the rear panel, as follows.

OFF: Both sets of speakers are off.

A/B: The set of speakers connected to the A or B terminals is on.

A+B BI-WIRING: Both sets of speakers are on.

Caution

If you use two sets (A and B), the impedance of each speaker must be 8 Ω or higher.

⑥ **METER selector**

Switches the display of the meter to OFF, PEAK or VU.

OFF: Turns off the meter and the illumination.

PEAK: Switches the meter to a peak level meter. The peak level meter shows a momentarily highest audio output level.

VU: Switches the meter to a VU (Volume Unit) level meter. The VU level meter shows an effective audio output value that is similar to human senses.

⑦ **Meter displays (LEFT/RIGHT)**

Show the audio output level of the left (LEFT) and right (RIGHT) channels in VU or PEAK meter mode. The VU or PEAK meter can be selected by the METER selector.

⑧ **BASS control**

Increases or decreases the low frequency response. The 0 position produces a flat response.

Control range: -10 dB to +10 dB

⑨ **TREBLE control**

Increases or decreases the high frequency response. The 0 position produces a flat response.

Control range: -10 dB to +10 dB

⑩ **BALANCE control**

Adjusts the audio output balance of the left and right speakers to compensate for sound imbalances caused by speaker locations or listening room conditions.

Notes

- When both the BASS and TREBLE controls are set to the 0 position, audio signal bypasses the tone control circuitry.
- The BASS, TREBLE and BALANCE controls do not affect the signals input at the MAIN IN jacks and signals output at the LINE 2 REC jacks.

Controls and functions

■ Front panel (pages 6 to 9)

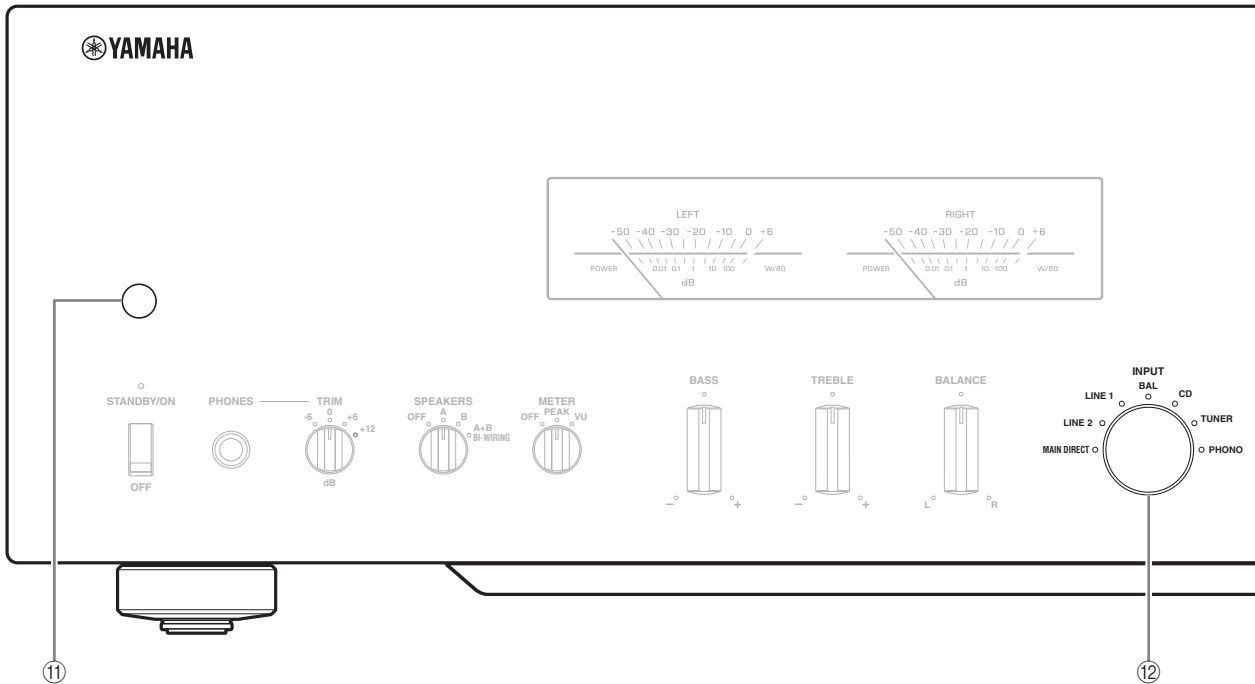

⑪ Remote control sensor

Receives signals from the remote control.

⑫ INPUT selector/indicator

Selects the input source to be played back. The indicator of the input source selected with the INPUT selector lights.

The audio signals of the selected input source are also output at the LINE 2 REC jacks.

MAIN DIRECT: Selects the component connected to the MAIN IN jacks.

When MAIN DIRECT is selected as the input source, the audio signals are not output at the PRE OUT, LINE 2 REC and PHONES jacks.

LINE 1/LINE 2: Selects the component connected to the LINE 1 or LINE 2 jacks.

BAL: Selects the component connected to the BAL jacks (balanced XLR jacks).

CD: Selects the CD player connected to the CD jacks (unbalanced RCA jacks).

TUNER: Selects the tuner connected to the TUNER jacks.

PHONO: Selects the turntable connected to the PHONO jacks.

Note

When LINE 2 is selected, the audio signals are not output at the LINE 2 REC jacks.

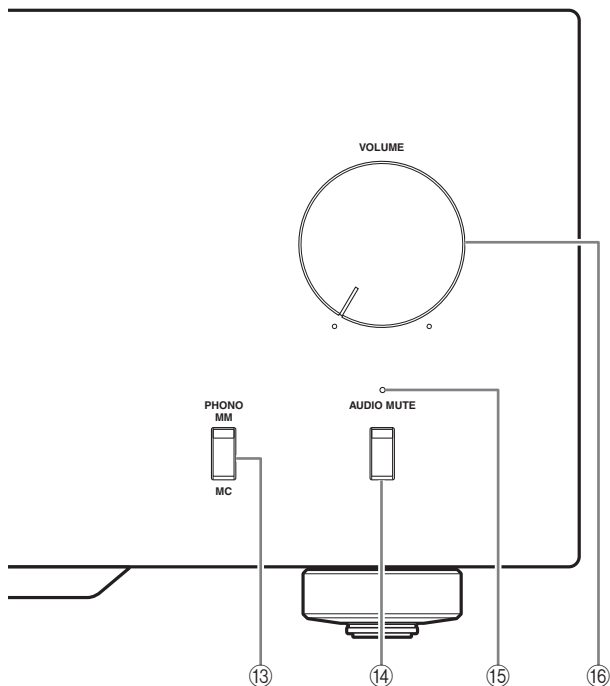

⑬ **PHONO switch**

Selects the type of cartridge of the turntable connected to the PHONO jacks on the rear panel.

MM: Choose this setting if the connected turntable uses an moving magnet (MM) cartridge.

MC: Choose this setting if the connected turntable uses an moving coil (MC) cartridge.



When you replace the cartridge, be sure to turn off this unit.

⑭ **AUDIO MUTE switch**

Press downward to reduce the current volume level by approximately 20 dB. Press again to restore the audio output to the previous volume level.



You can also rotate the VOLUME control on the front panel or press the VOLUME + or – key on the remote control to resume the audio output.

⑮ **AUDIO MUTE indicator**

Lights when the mute function is turned on with the AUDIO MUTE switch.

⑯ **VOLUME control**

Controls the volume level. This does not affect the output level at the LINE 2 REC jacks.

Note

The VOLUME control does not affect when you select MAIN DIRECT as the input source. Adjust the volume level using the volume control on the external amplifier connected to the MAIN IN jacks.

Controls and functions

■ Rear panel

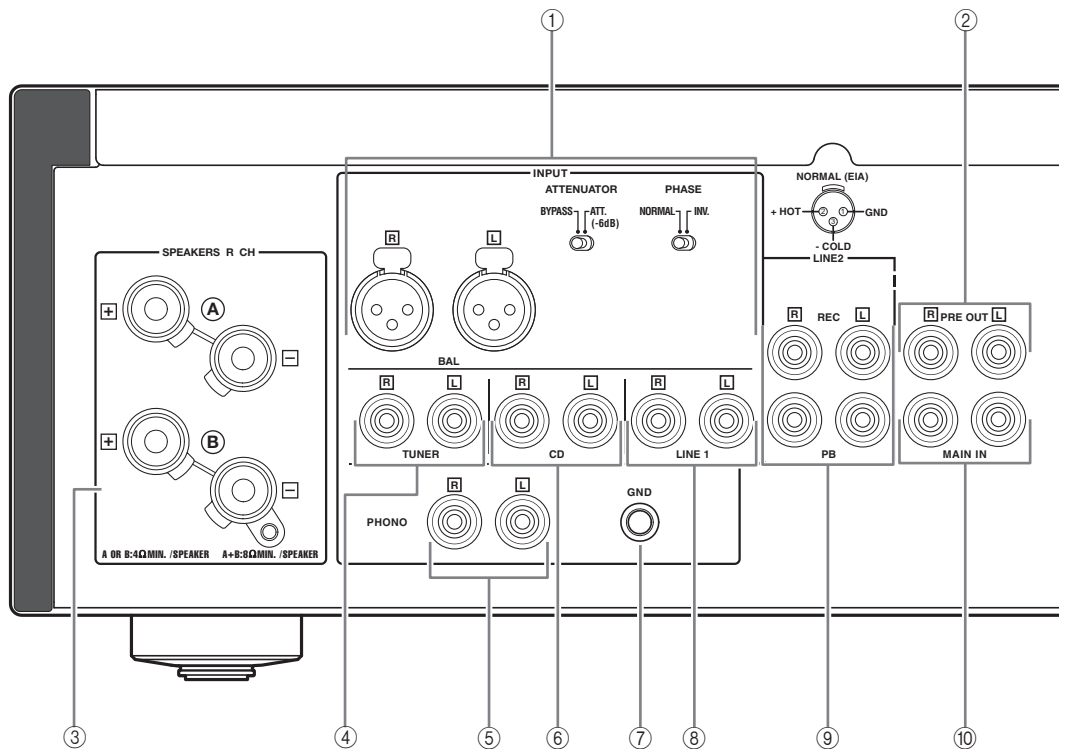

See page 16 for connection information.

① BAL (balanced) input jacks

One set of balanced input jacks is provided. Set the ATTENUATOR selector and PHASE selector appropriately for the playback component that is connected. For details on these switches, refer to page 20.

② PRE OUT jacks



- The PRE OUT jacks output the same channel signal as the SPEAKERS L/R CH terminals.
- When you connect a stereo cable to the PRE OUT jacks to drive the speakers using an external amplifier, it is not necessary to use the SPEAKERS L/R CH terminals.
- The signal output at the PRE OUT jacks are affected by the BASS and TREBLE control settings.

③ SPEAKERS L/R CH terminals

④ TUNER input jacks

⑤ PHONO input jacks

⑥ CD input jacks

⑦ GND (Ground) terminal

⑧ LINE 1 input jacks

⑨ LINE 2 jacks

PB (playback) input jacks and REC (recording) output jacks are provided.

⑩ MAIN IN jacks

Use these jacks to connect an external component equipped with a volume control.



When you select MAIN DIRECT as the input source, the volume level is fixed.

Adjust the volume level using the volume control on the external amplifier connected to the MAIN IN jacks when you select MAIN DIRECT as the input source.

For the connection to the MAIN IN jacks, see pages 16 and 17.

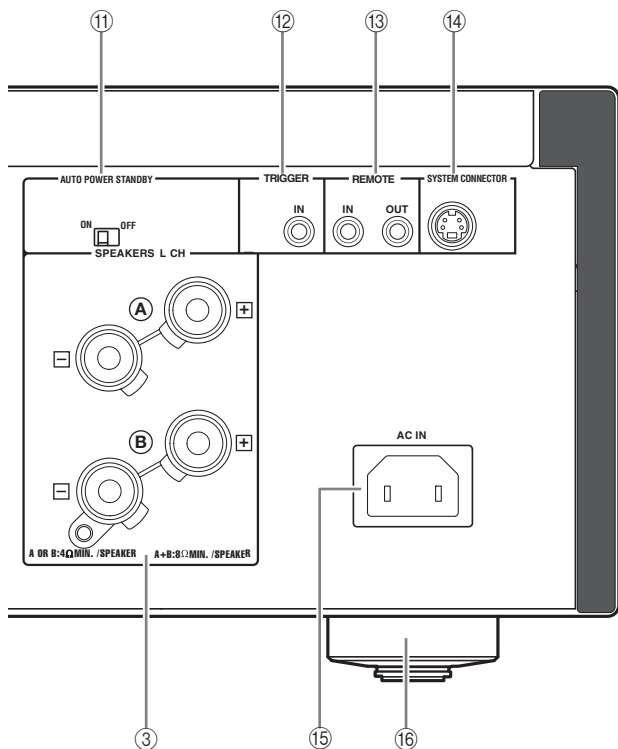

11 AUTO POWER STANDBY switch

ON: The unit enters STANDBY mode automatically if not operated for 8 hours.

OFF: The unit does not enter STANDBY mode automatically.

12 TRIGGER IN jack

Use this jack to connect an external component for the trigger function.

For details on the connection, see page 22.

13 REMOTE IN/OUT jacks

Use these jacks to connect an external component for remote control.

For details on the connection, see page 21.

14 SYSTEM CONNECTOR

Use this connector to connect a product testing device for servicing.

15 AC IN inlet

Use this inlet to plug in the supplied power cable.

For details on the connection, see page 19.

16 Foot

The feet of this unit include built-in spikes. Using the spikes can reduce the effect of vibrations on the set. When using the spikes, remove the transport tape, then remove the magnet foot by pulling it.

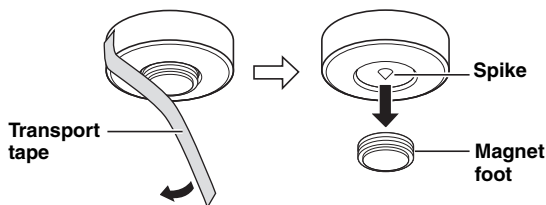

Caution

- Take care that the magnet foot is not accidentally swallowed by small children.
- When using the feet's built-in spikes, the spikes may scratch the shelf or floor on which this unit is installed. Use the magnet feet or appropriate supports when placing this unit on expensive furniture, etc.



If this unit is unstable, you can adjust the foot height by rotating it.

Controls and functions

■ Remote control

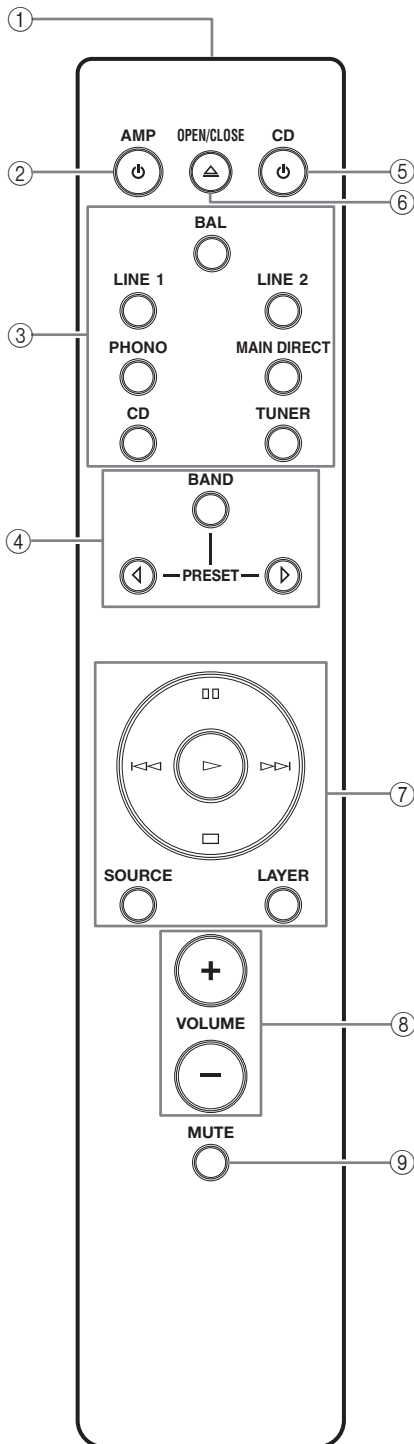

① Infrared signal transmitter

Outputs infrared control signals.

② AMP key

Turns this unit ON or switches it to STANDBY mode. For details on STANDBY mode, see “Front panel” (page 6).

③ Input select keys

Selects the input source to be played back. The audio signals of the selected input source are output at the LINE 2 REC jacks.



When LINE 2 is selected as the input source, the audio signals are not output at the LINE 2 REC jacks.

BAL: Selects the component connected to the BAL jacks (balanced XLR jacks).

LINE: Selects the component connected to the LINE 1 or LINE 2 jacks.

PHONO: Selects the turntable connected to the PHONO jacks.

MAIN DIRECT: Selects the component connected to the MAIN IN jacks. When MAIN DIRECT is selected as the input source, the audio signals are not output at the PRE OUT, LINE 2 REC and PHONES jacks.

CD: Selects the CD player connected to the CD jacks (unbalanced RCA jacks).

TUNER: Selects the tuner connected to the TUNER jacks.

④ Yamaha tuner control buttons

Control functions of Yamaha tuner. Refer to the owner’s manual of your tuner for details.

Note

Some Yamaha tuners cannot be controlled by this remote control.

⑤ **⏻ CD key**

Turns the Yamaha CD player ON or switches it to STANDBY mode.

⑥ **⏮ OPEN/CLOSE key**

Opens/closes the disc tray of the Yamaha CD player. Refer to the owner's manual of your CD player for details.

Note

Some Yamaha CD players do not support the ⏻ CD key and/or ⏮ OPEN/CLOSE key of this remote control.

⑦ **Yamaha CD player control keys**

Control various functions of Yamaha CD player. Refer to the owner's manual of your CD player for details.

▶ **(Play):** Starts playback.

⏸ **(Pause):** Pauses playback. Press the ▶ or ⏸ to resume playback.

⏹ **(Stop):** Stops playback.

⏮ / ⏭ **(Skip):** Skips to the next track, or skips back to the beginning of the current track.

SOURCE: Selects the source to be played on the Yamaha CD player. The playback source changes each time this key is pressed.

LAYER: Switches the playback layer of a hybrid SA-CD between SA-CD and CD.

⑧ **VOLUME +/- keys**

Control the volume level.

Note

The VOLUME keys do not affect when you select MAIN DIRECT as the input source. Adjust the volume level on the external amplifier connected to the MAIN IN jacks.

⑨ **MUTE key**

Reduces the current volume level by approximately 20 dB. Press again to restore the audio output to the previous volume level. Pressing the VOLUME + or – key also cancels muting.

Controls and functions

■ Installing batteries in the remote control

- 1 Remove the battery compartment cover.
- 2 Insert the two batteries (AAA, R03, UM-4) according to the polarity markings (+ and -) on the inside of the battery compartment.

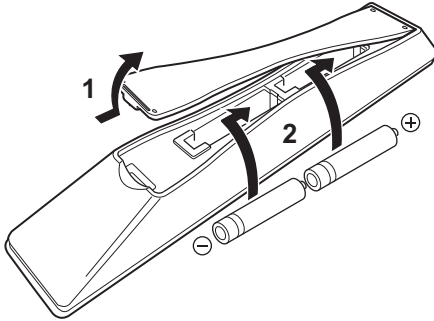

- 3 Reinstall the battery compartment cover.

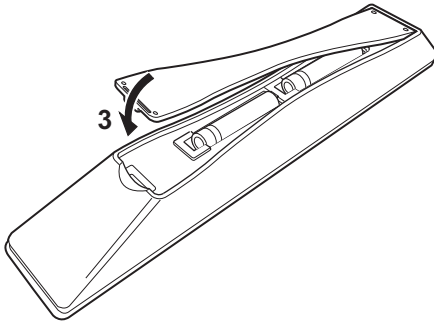

■ Operating range of the remote control

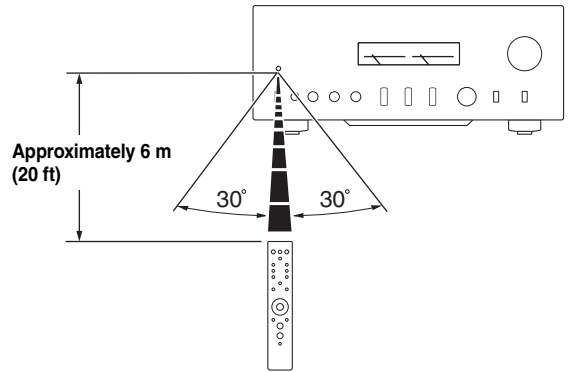

The remote control transmits a directional infrared beam. Be sure to aim the remote control directly at the remote control sensor on the front panel of this unit during operation.

Connections

In this section, you will make connections between A-S2100, speakers, and source components.



Connections

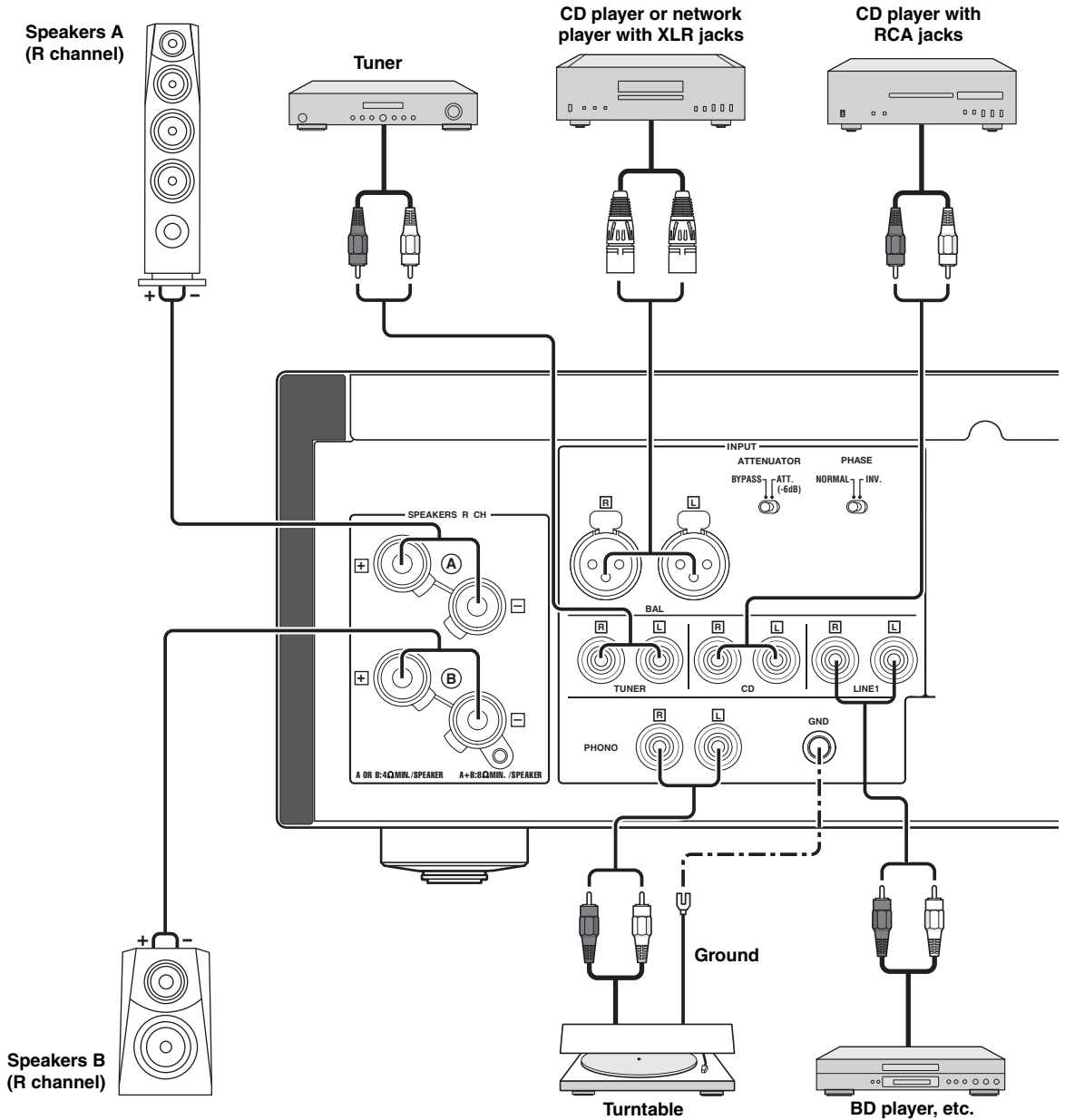

Notes

- Do not let the bare speaker wires touch each other or do not let them touch any metal part of this unit. This could damage this unit and/or the speakers.
- All connections must be correct: L (left) to L, R (right) to R, “+” to “+”, and “-” to “-”. If the connections are faulty, no sound will be heard from the speakers, and if the polarity of the speaker connections is incorrect, the sound will be unnatural and lack bass. Also, refer to the owner’s manual for each of your components.
- Use RCA unbalanced cables to connect other components except speakers. Use XLR balanced cables to connect a CD player or network player with XLR balanced output jacks to the BAL jacks of this unit.
- Connect your turntable to the GND terminal to reduce noise in the signal. However, you may hear less noise without the connection to the GND terminal for some turntables.

External amplifier or active subwoofer

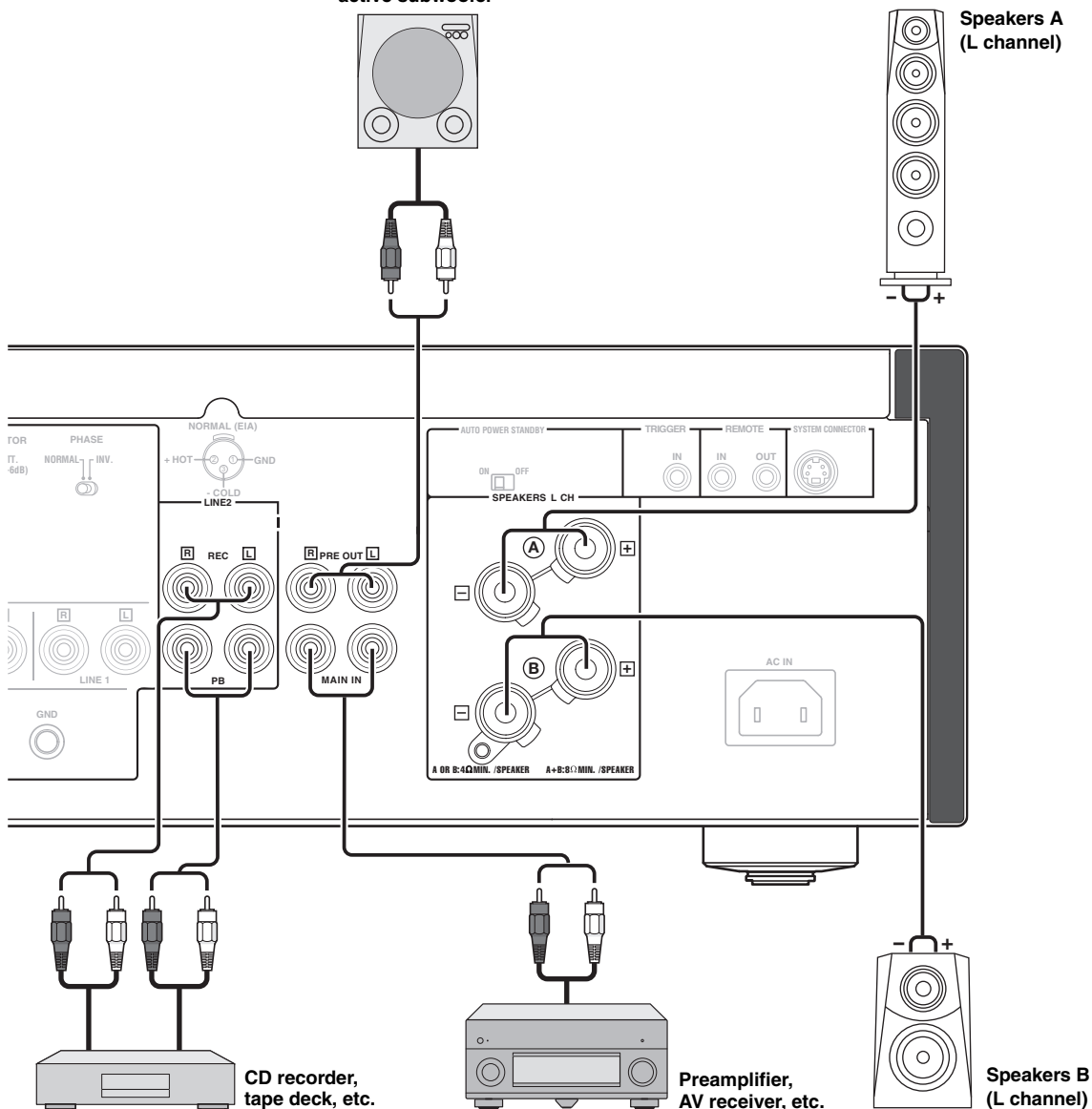

Notes

- Because the power amplifier of A-S2100 is of the floating balanced type, the following types of connections are not possible.
 - Connecting with the left channel “-” terminal and the right channel “-” terminal as well as “+” terminals (Fig. 1).
 - Connecting with the left channel “-” terminal and the right channel “-” terminal inverted (cross connection, Fig. 2).
 - Deliberately connecting with the left/right channel “-” terminals and metal part on the rear panel of this unit, as well as accidentally touching them.
- Do not connect your active subwoofer to the SPEAKERS L/R CH terminal. Connect it to the PRE OUT jacks of this unit.
- Do not connect a component with no volume control, such as a CD player, to the MAIN IN jacks, as the volume level of the signals input to the MAIN IN jacks is fixed. If such equipment is connected, a sound may burst, and the unit and/or speaker may be damaged.

Fig. 1

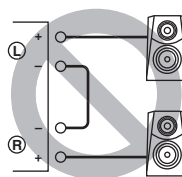
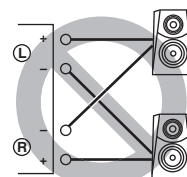

Fig. 2



Connections

■ Connecting the speakers

- 1 Remove approximately 10 mm of insulation from the end of each speaker cable and twist the exposed wires of the cable together to prevent short circuits.

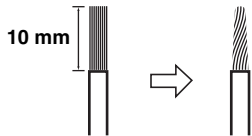

- 2 Unscrew the knob and then insert the bare wire into the hole.

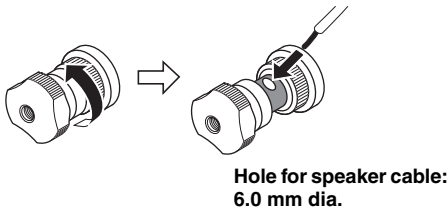

- 3 Tighten the knob.



Caution

When loosening the knob of the speaker terminal, do not rotate it excessively. The knob may come off and pose the danger of being swallowed by a child.

Notes

- Touching the speaker terminal with a metallic rack may cause short circuit and damage this unit. When installing the unit in a rack, maintain a sufficient clearance to prevent the speaker terminals from touching the rack.
- To reduce the risk of electric shock, do not touch the speaker terminal when the unit is turned on.

■ Connecting the banana plug (Except for Europe models)

First, tighten the knob and then insert the banana plug into the end of the corresponding terminal.

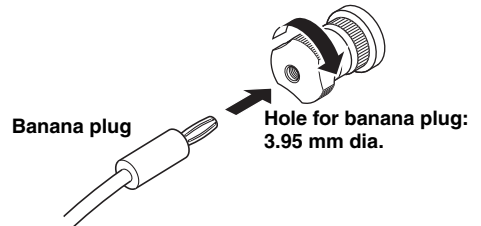

■ Connecting the Y-shaped lug

- 1 Unscrew the knob and then sandwich the Y-shaped lug between the ring part and base.

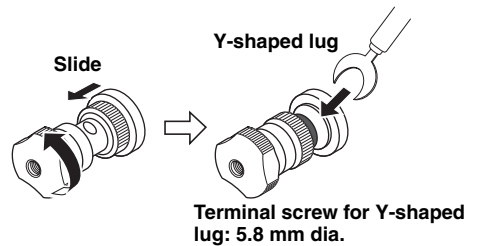

- 2 Tighten the knob.

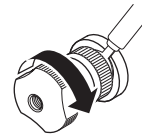

■ Bi-wire connection

The bi-wire connection separates the woofer from the combined midrange and tweeter section. A bi-wire compatible speaker has four binding post terminals. These two sets of terminals allow the speaker to be split into two independent sections. This split connects the mid and high frequency drivers to one set of terminals and the low frequency driver to the other pair.

Example of a bi-wiring connection (R channel)

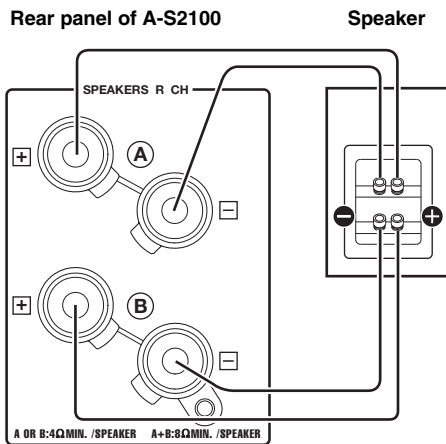

Caution

To use the bi-wire connections, the impedance of each speaker must be 8 Ω or higher.

Note

Remove the shorting bars or bridges to separate the LPF (low pass filter) and HPF (high pass filter) crossovers.



To use the bi-wire connections, switch the SPEAKERS selector on the front panel to the A+B BI-WIRING position.

■ Connecting the power cable

Plug the power cable into the AC IN inlet when all connections are complete, and then plug in the power cable to the AC outlet.

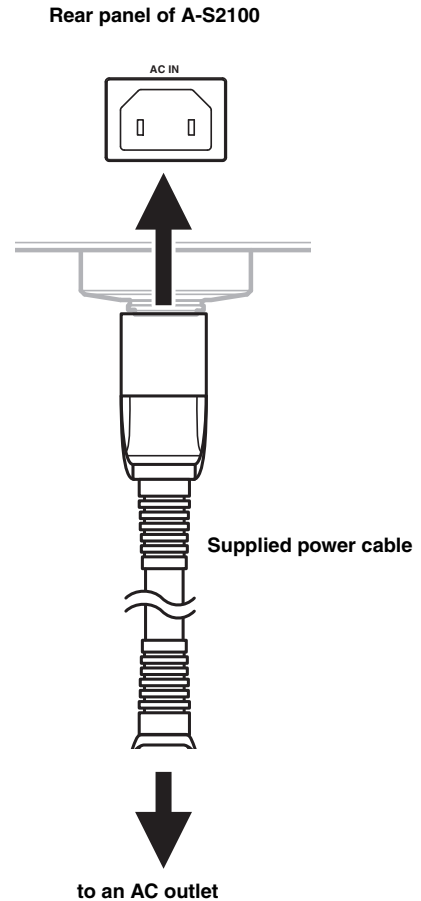

Connections

■ Connecting to the BAL jacks

Connect your CD player or network player with the XLR balanced output jacks.

Set the ATTENUATOR selector and PHASE selector located above the BAL jacks according to the component to be connected.

ATTENUATOR selector:

Select the allowable input level for the XLR balanced input jacks. If sound from the connected component is distorted, set the ATTENUATOR selector to ATT. (-6 dB).

PHASE selector:

Select the assignment of the HOT pin of the XLR balanced input jacks (pin 2 HOT or pin 3 HOT).

NORMAL (pin 2 HOT)

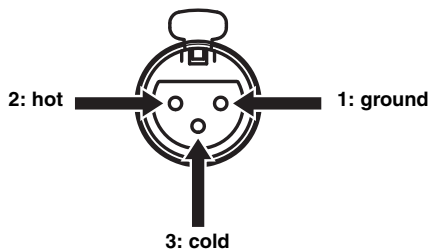

INV. (pin 3 HOT)

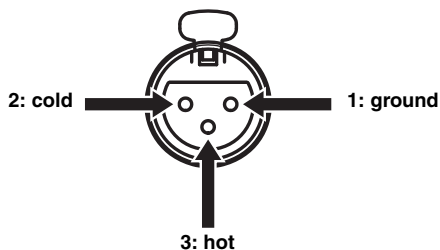

Refer to the owner's manual supplied with the connected component and verify the assignment of the HOT pin of its XLR balanced output jacks.



Yamaha CD players are set to NORMAL (pin 2 HOT).

XLR connectors:

When connecting, be sure to match the pins and insert the connector of the "male" XLR balanced cable until you hear a "click". When disconnecting, pull out the "male" XLR balanced cable while holding down the lever of the BAL jack.

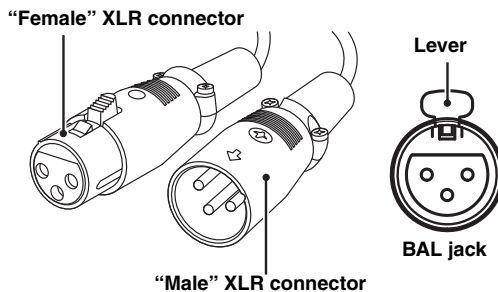

Note

To select the component connected to the BAL jacks, set the input source to BAL.

■ Operating this unit from another room

If you connect an infrared receiver and transmitter to the REMOTE IN/OUT jacks of this unit, you can operate the unit and/or external component using the supplied remote control located in another room.

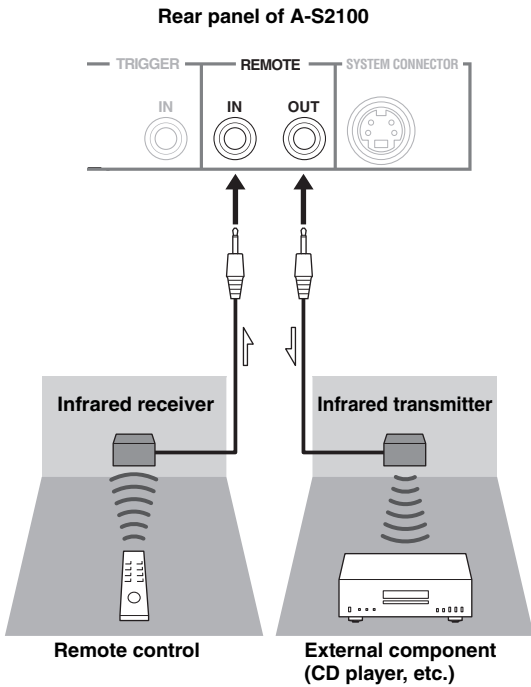

■ Remote connection between Yamaha components

When you have another Yamaha component supporting remote connection, as this unit does, an infrared transmitter is not necessary. You can transmit remote signals by connecting an infrared receiver and the REMOTE IN jack of the other component to the REMOTE IN/OUT jacks of this unit, using cables with monaural miniplugs.

Up to three Yamaha components (including this unit) can be connected.

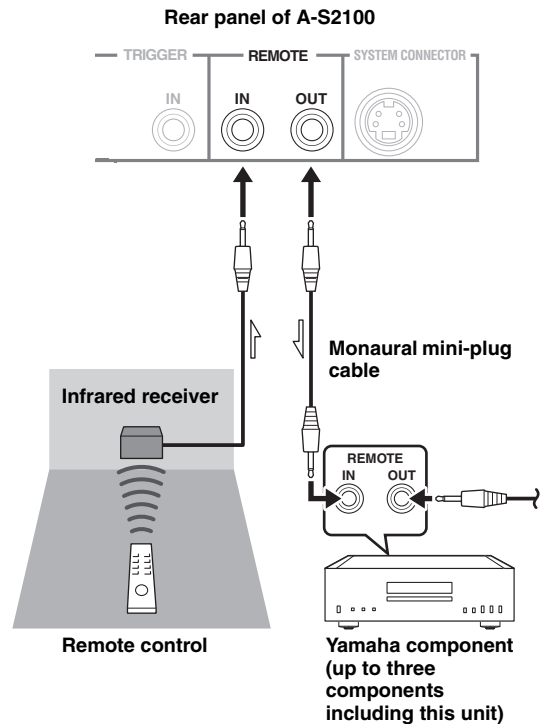

Connections

■ Connecting a component supporting the trigger function such as a Yamaha AV receiver

The operations of this unit can be controlled in synchronization with the operations of the connected component, such as a Yamaha AV receiver (power ON/STANDBY or MAIN DIRECT input selection). Connect the PRE OUT jacks and the TRIGGER OUT jack of the Yamaha AV receiver to this unit as illustrated below:

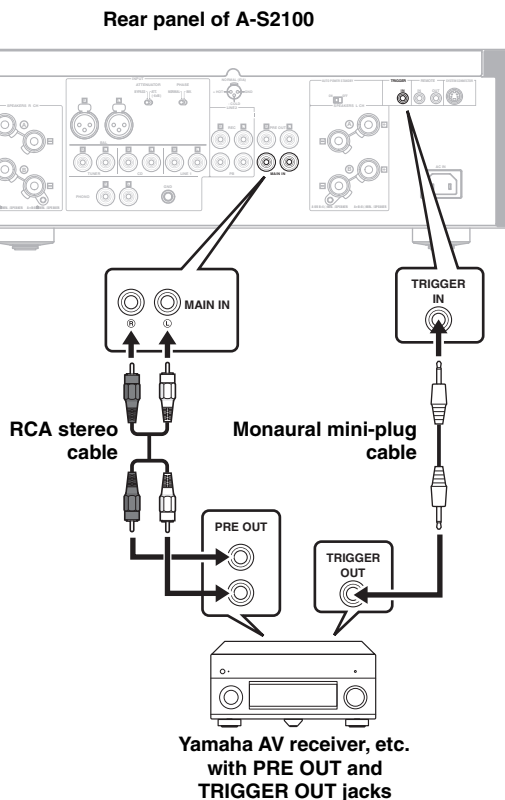

When the power of the connected component is turned on, this unit turns on and the input is set to MAIN DIRECT automatically.

When MAIN DIRECT is selected as the input source, this unit enters STANDBY mode if the power of the connected component is turned off.

Note

To enable synchronization, turn off this unit before connecting the component to the MAIN IN jacks. The synchronization cannot be activated when the STANDBY/ON, OFF switch of the unit has been set to OFF.

Specifications

In this section, you will find technical specifications for A-S2100.



Specifications

POWER SECTION

- Rated Output Power
 - [U.S.A, Canada, Taiwan, China, Korea, Australia, U.K. and Europe models]
 - (8 Ω, 20 Hz to 20 kHz, 0.07% THD) 90 W + 90 W
 - (4 Ω, 20 Hz to 20 kHz, 0.07% THD) 150 W + 150 W
 - [Asia model]
 - (8 Ω, 20 Hz to 20 kHz, 0.07% THD) 90 W + 90 W
 - (4 Ω, 20 Hz to 20 kHz, 0.07% THD) 110 W + 110 W
- Dynamic Power (IHF)
 - (8 Ω) 105 W + 105 W
 - (6 Ω) 135 W + 135 W
 - (4 Ω) 190 W + 190 W
 - (2 Ω) 220 W + 220 W
- Dynamic Headroom
 - (8 Ω) 0.67 dB
- Maximum Output Power
 - [U.K. and Europe models only]
 - (1 kHz, 0.7% THD, 4 Ω) 160 W + 160 W
- Maximum Effective Output Power (JEITA)
 - [Taiwan, China, Korea, Asia and U.K. models only]
 - (1 kHz, 10% THD, 8 Ω) 120 W + 120 W
 - (1 kHz, 10% THD, 4 Ω) 190 W + 190 W
- IEC Output Power [U.K. and Europe models only]
 - (1 kHz, 0.02% THD, 8 Ω) 95 W + 95 W
- Power Bandwidth
 - (MAIN L/R, 0.1% THD, 45 W, 8 Ω) 10 Hz to 50 kHz
- Damping Factor
 - (1 kHz, 8 Ω) 250 or higher
- Maximum Input Signal Voltage
 - PHONO MM (1 kHz, 0.5% THD) 50 mVrms
 - PHONO MC (1 kHz, 0.5% THD) 2.2 mVrms
 - CD, etc. (1 kHz, 0.5% THD) 2.80 Vrms
 - BAL (1 kHz, 0.5% THD)
 - (BYPASS) 2.80 Vrms
 - (ATT. -6 dB) 5.60 Vrms
- Rated Output Voltage/Output Impedance
 - REC OUT 200 mVrms/1.5 kΩ
 - PRE OUT 1.0 Vrms/1.5 kΩ
- Frequency Response
 - CD, etc. (5 Hz to 100 kHz) +0/-3 dB
 - CD, etc. (20 Hz to 20 kHz) +0/-0.3 dB
- RIAA Equalization Deviation
 - PHONO MM ±0.5 dB
 - PHONO MC ±0.5 dB
- Total Harmonic Distortion Plus Noise
 - PHONO MM to REC OUT
 - (20 Hz to 20 kHz, 1.2 Vrms) 0.005%
 - PHONO MC to REC OUT
 - (20 Hz to 20 kHz, 1.2 Vrms) 0.02%
 - BAL to SPEAKERS OUT
 - (20 Hz to 20 kHz, 50 W/8 Ω) 0.025%
 - CD, etc. to SPEAKERS OUT
 - (20 Hz to 20 kHz, 50 W/8 Ω) 0.025%
- Signal to Noise Ratio (IHF-A Network)
 - PHONO MM (5 mVrms, Input shorted) 93 dB
 - PHONO MC (500 μVrms, Input shorted) 85 dB
 - CD, etc. (200 mVrms, Input shorted) 103 dB
- Residual Noise (IHF-A Network) 33 μVrms

CONTROL SECTION

- Input Sensitivity/Input Impedance
 - CD, etc. 200 mVrms/47 kΩ
 - PHONO MM 2.5 mVrms/47 kΩ
 - PHONO MC 100 μVrms/50 Ω
 - MAIN IN 1.0 Vrms/47 kΩ
 - BAL 200 mVrms/100 kΩ
- Headphone Jack Rated Output Power
 - CD, etc. (1 kHz, 32 Ω, 0.2% THD) 50 mW + 50 mW
- Channel Separation
 - CD, etc. (Input, 5.1 kΩ Terminated, 1 kHz/10 kHz)
 - 74/54 dB or higher
 - PHONO MM (Input shorted, 1 kHz/10 kHz, Vol.: -30 dB)
 - 90/77 dB or higher
 - PHONO MC (Input shorted, 1 kHz/10 kHz, Vol.: -30 dB)
 - 66/77 dB or higher
- Tone Control Characteristics
 - BASS
 - Boost/Cut (50 Hz) ±9 dB
 - Turnover Frequency 350 Hz
 - TREBLE
 - Boost/Cut (20 kHz) ±9 dB
 - Turnover Frequency 3.5 kHz

GENERAL

- Power Supply
 - [U.S.A and Canada models] AC 120 V, 60 Hz
 - [Taiwan model] AC 110 V, 60 Hz
 - [China model] AC 220 V, 50 Hz
 - [Korea model] AC 220 V, 60 Hz
 - [Australia model] AC 240 V, 50 Hz
 - [U.K. and Europe models] AC 230 V, 50 Hz
 - [Asia model] AC 220 - 240 V, 50/60 Hz
 - Power Consumption
 - [U.S.A and Canada models] 500 VA
 - [Asia model] 250 W
 - [Other models] 350 W
 - Standby Power Consumption 0.3 W
 - Dimensions (W × H × D) 435 × 157 × 463 mm
(17-1/8" × 6-1/8" × 18-1/4")
 - Weight 23.4 kg (51.6 lbs)
- * Specifications are subject to change without notice.

■ Block diagram

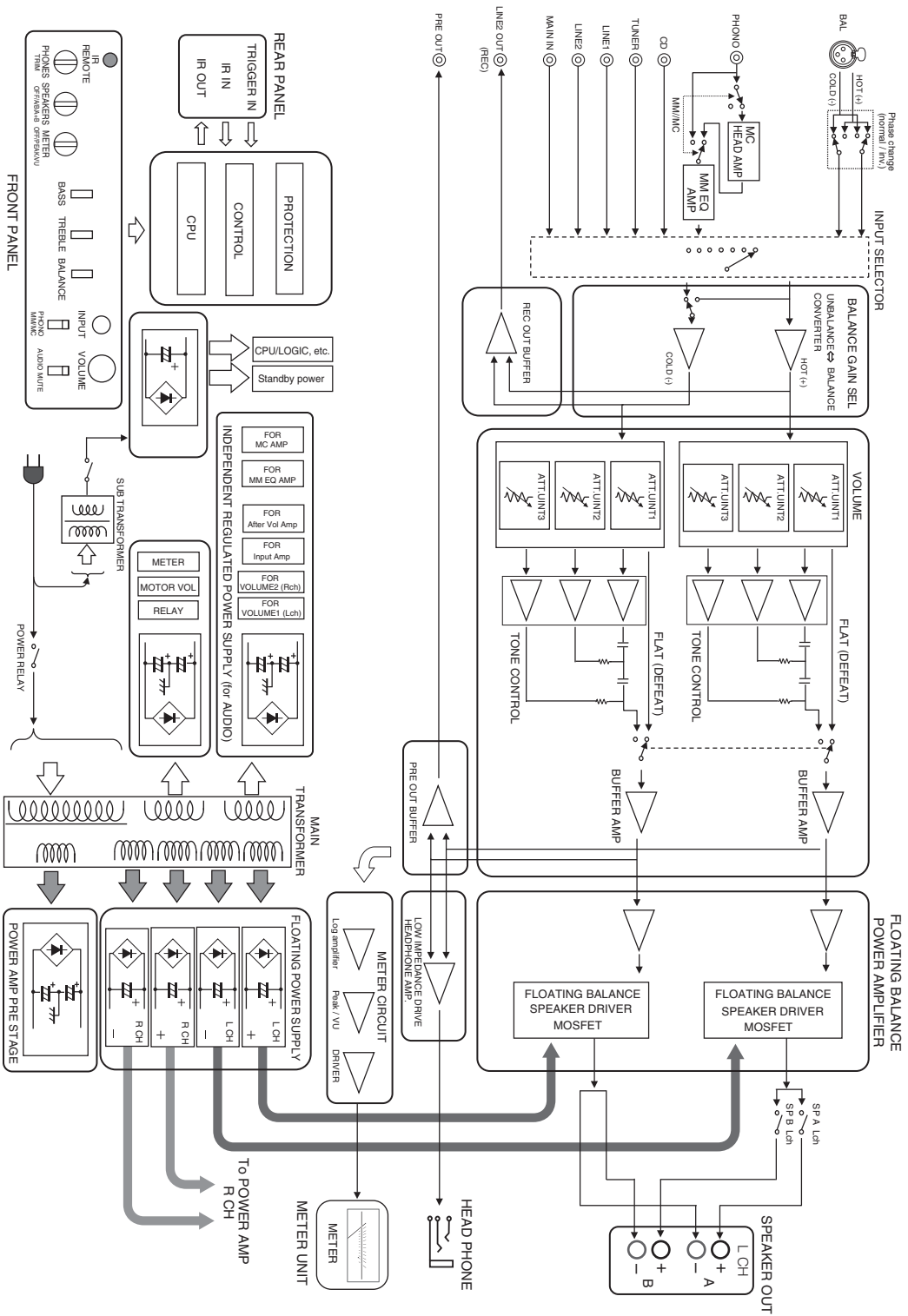

Specifications

■ Tone control characteristics

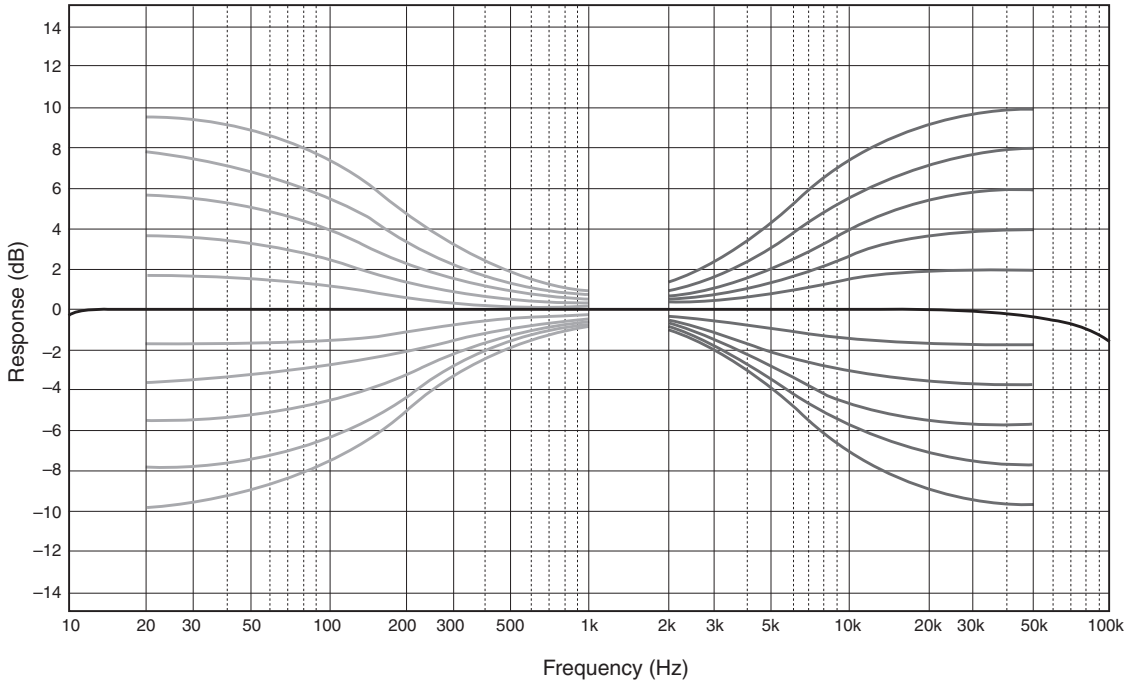

■ Total harmonic distortion

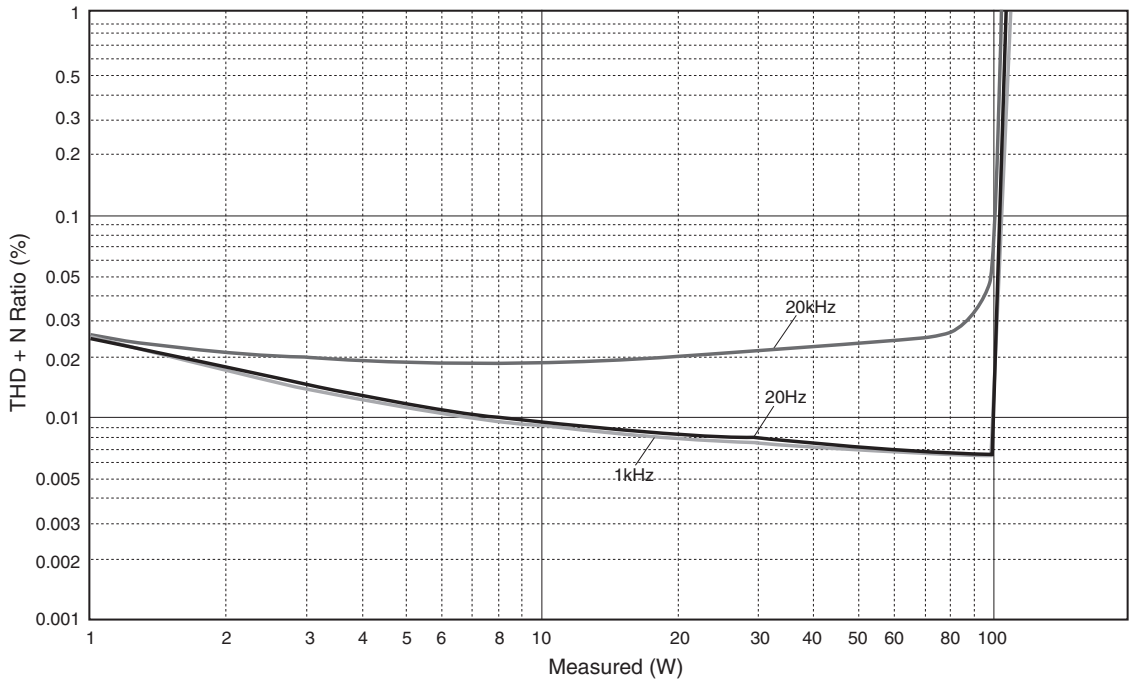

■ Total harmonic distortion (PHONO)

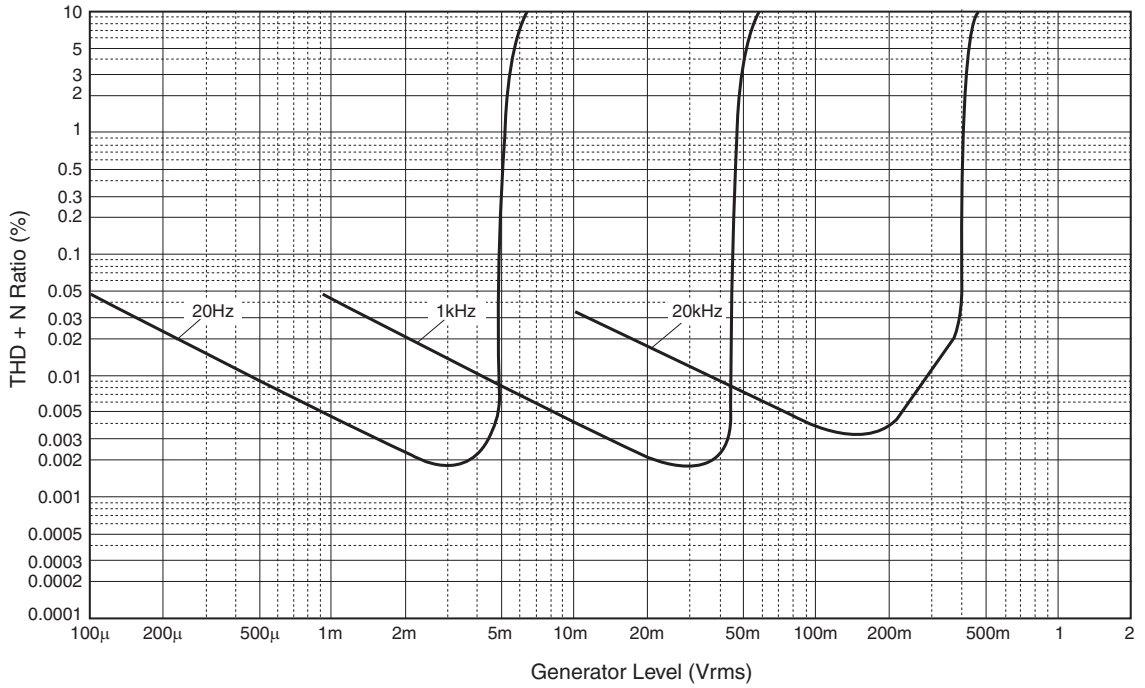

Troubleshooting

Refer to the chart below if this unit does not function properly. If the problem you are experiencing is not listed below or if the instructions below do not help, turn off this unit, disconnect the power cable, and contact the nearest authorized Yamaha dealer or service center.

Problem	Cause	Remedy	See page
This unit fails to turn on.	The power cable is not connected to the AC IN inlet on the rear panel or not plugged in the AC wall outlet.	Connect the power cable firmly.	19
	The protection circuitry has been activated because of a short circuit, etc.	Check that the speaker wires are not touching each other or shorting out against the rear panel of this unit, and then turn the power of this unit back on.	18
	This unit has been exposed to a strong external electric shock (such as lightning or strong static electricity).	Turn off this unit, disconnect the power cable, plug it back in after 30 seconds, and then use it normally.	—
The STANDBY/ON indicator on the front panel flashes.	The protection circuitry has been activated because of a short circuit, etc.	Check that the speaker wires are not touching each other or shorting out against the rear panel of this unit, and then turn the power of this unit back on.	18
	There is a problem with the internal circuitries of this unit.	Disconnect the power cable and contact the nearest authorized Yamaha dealer or service center.	—
The INPUT indicator on the front panel flashes and the volume is turned down when you turn on this unit.	The protection circuitry has been activated because of a short circuit, etc.	Check that the speaker wires are not touching each other or shorting out against the rear panel of this unit, and then turn the power of this unit back on.	18
No sound.	Incorrect input or output cable connections.	Connect the cables properly. If the problem persists, the cables may be defective.	16
	No appropriate input source has been selected.	Select an appropriate input source with the INPUT selector on the front panel (or one of the input selector keys on the remote control).	8, 12
	The SPEAKERS selector is set to OFF.	Switch the SPEAKERS selector to the appropriate position.	7
	Speaker connections are not secure.	Secure the connections.	18
The sound suddenly goes off.	The protection circuitry has been activated because of a short circuit, etc.	Check that the speaker wires are not touching each other or shorting out against the rear panel of this unit, and then turn the power of this unit back on.	18
The volume level cannot be adjusted.	MAIN DIRECT is selected as the input source.	Adjust the volume on the connected component. Or connect external component to input jacks other than MAIN IN and select the corresponding input source.	8, 9
Only the speaker on one side can be heard.	Incorrect cable connections.	Connect the cables properly. If the problem persists, the cables may be defective.	16
	Incorrect setting for the BALANCE control.	Set the BALANCE control to the appropriate position.	7
There is a lack of bass and no ambience.	The + and – wires are connected in reverse at the amplifier or the speakers.	Connect the speaker wires to the correct + and – phase.	16
A “humming” sound is heard.	Incorrect cable connections.	Connect the audio cable plugs firmly. If the problem persists, the cables may be defective.	16
	No connection from the turntable to the GND terminal.	Connect the turntable to the GND terminal of this unit.	16

Problem	Cause	Remedy	See page
The sound from the component connected to the BAL jack is degraded.	The sound level is higher than the maximum input level for the XLR balanced input jacks.	If the output level of the connected component is double, set the ATTENUATOR selector located above the input jacks to ATT. (-6 dB).	20
Bass is not spatial when BAL (balanced input) is selected.	The polarity is incorrect.	Select the correct polarity with the PHASE selector.	20
The sound is degraded when listening with the headphones connected to the CD player connected to this unit.	The power of this unit is turned off.	Turn on the power of this unit.	—
The volume level is low while playing a record.	Incorrect setting for the PHONO switch on the front panel.	Switch the PHONO switch to the MM or MC position according to the type of magnetic cartridge of the turntable.	9
The remote control does not work or function properly.	Wrong distance or angle.	The remote control functions within a maximum range of 6 m (20 ft) and no more than 30 degrees off-axis from the front panel.	14
	Direct sunlight or lighting (from an inverter type of fluorescent lamp, etc.) is striking the remote control sensor of this unit.	Reposition this unit.	8
	The batteries are weak.	Replace all batteries.	14

Taking care of this unit

Polish finish on the side panels

Use of Yamaha Unicon cloth (sold separately) is recommended. For heavy dirt, use Yamaha Piano Unicon (sold separately). For purchasing, contact your nearest authorized Yamaha dealer or service center.

Other finish

When you wipe this unit, do not use chemical solvents (alcohol, thinner, etc.), which might damage the finish. Use a clean, dry cloth. For heavy dirt, dampen a soft cloth in detergent diluted with water, wring it out, and clean this unit with the cloth.

