

res right to change design and/or specifica-
e for purpose of improvement.

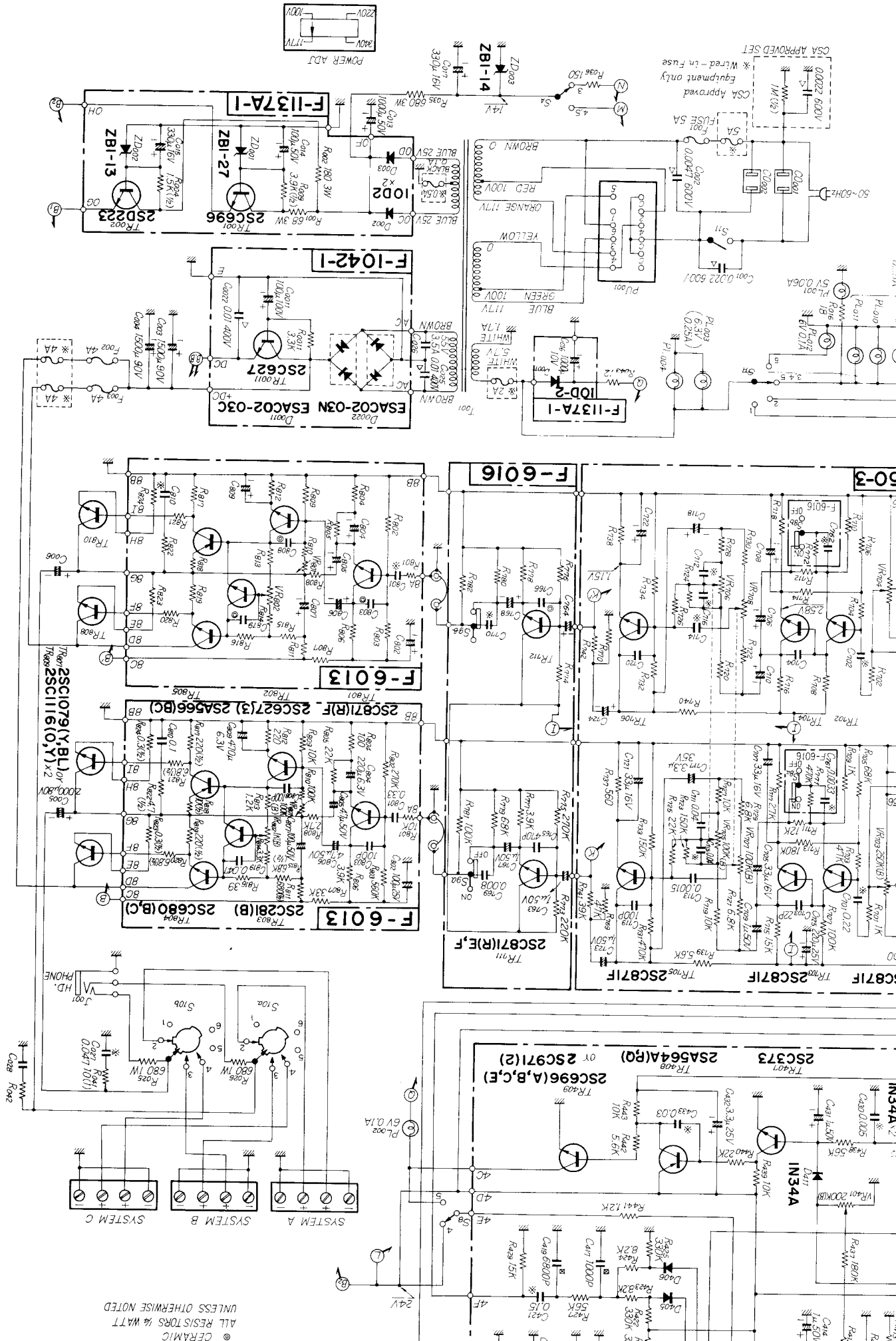

© CERAMIC
ALL RESISTORS % WATT
UNLESS OTHERWISE NOTED

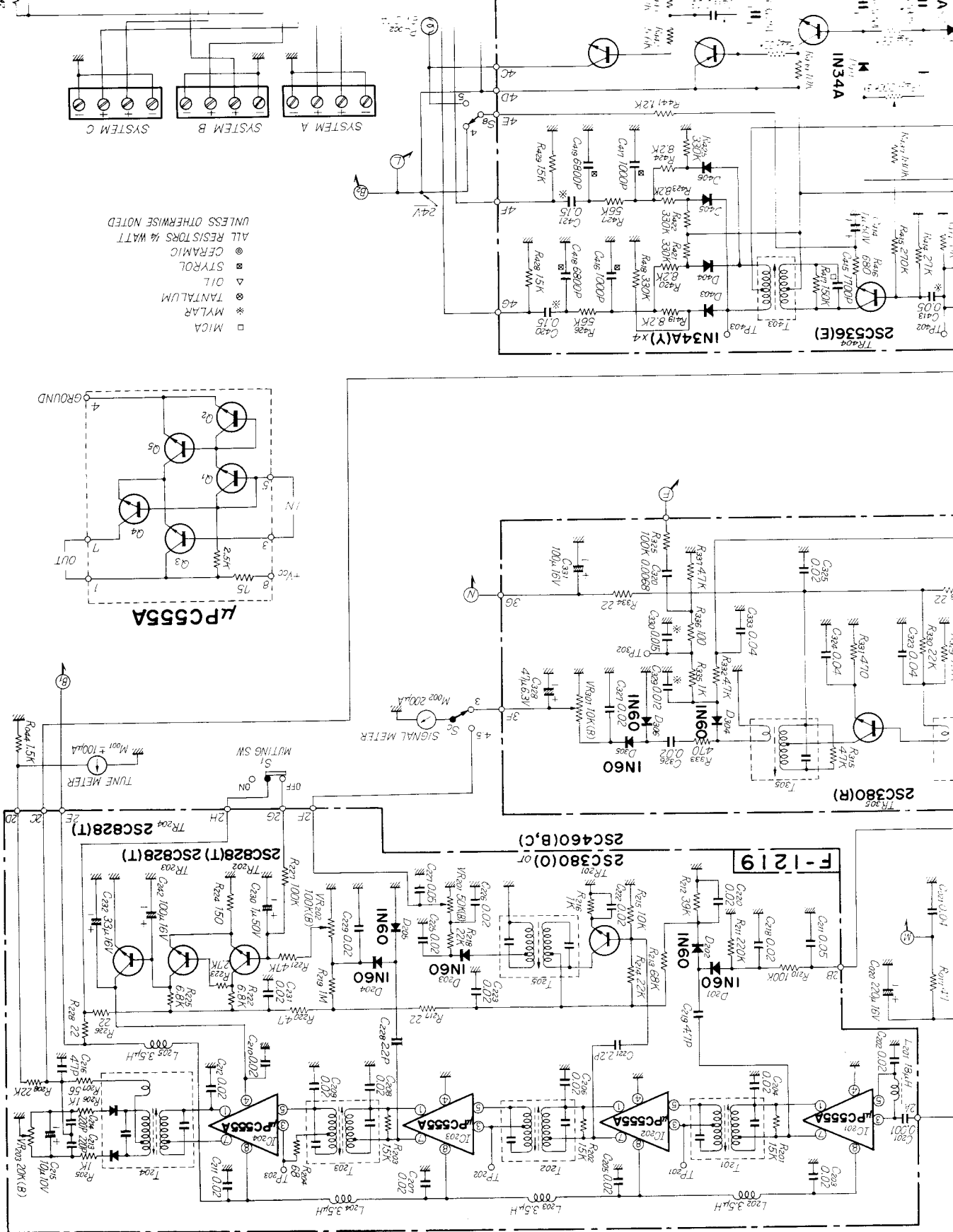

UNLESS OTHERWISE NOTED
 ALL RESISTORS 1/4 WATT
 ● CERAMIC
 ▣ STRAOL
 ▽ OIL
 ⊗ TANTALUM
 * MYLAR
 □ MICA

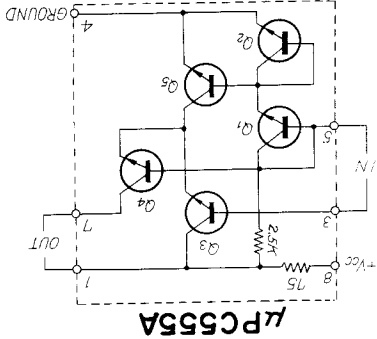

Sansui

SANSUI ELECTRIC COMPANY LIMITED

Printed in Japan (61030M)

SANSUI 5000X SCHEMATIC I

- S1 FM AUTO
- S2 AUX
- S7 MUTING
- S2 FM STEREO ONLY
- S3 TAPE MONITOR A
- S4 TAPE MONITOR B
- S5 REVERSE
- S6 MONO
- S7 LOUDNESS
- S8 HIGH FILTER
- S9 LOW FILTER
- S10 SPEAKERS SELECTOR
A.B.C A+B A+C

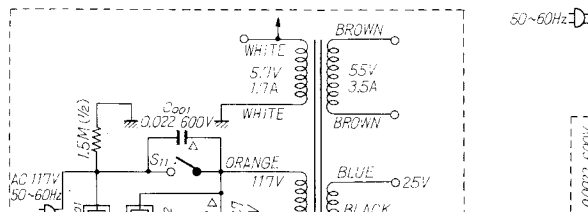
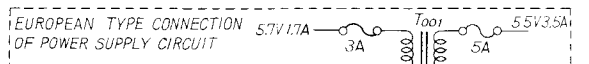
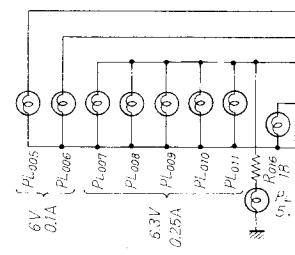
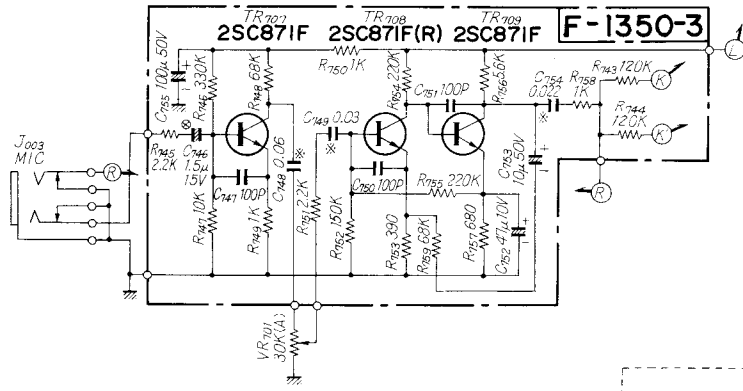
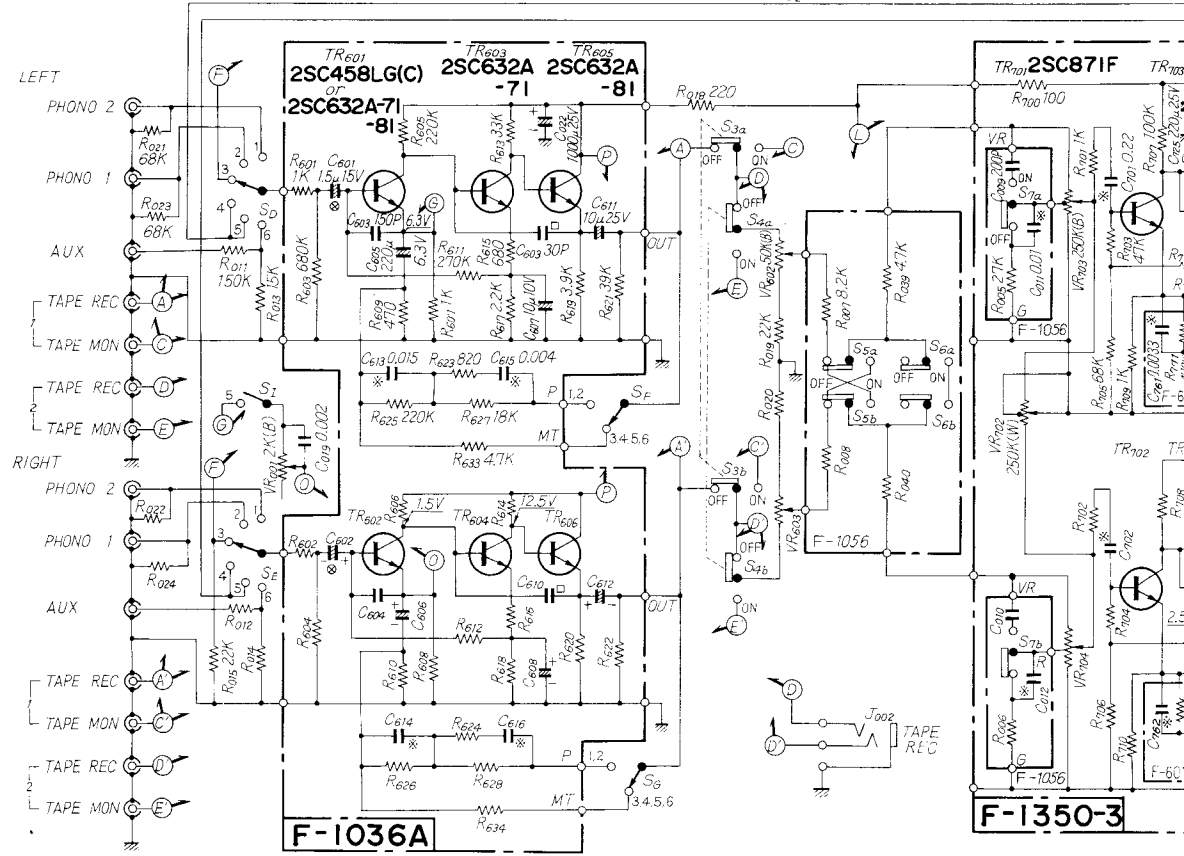
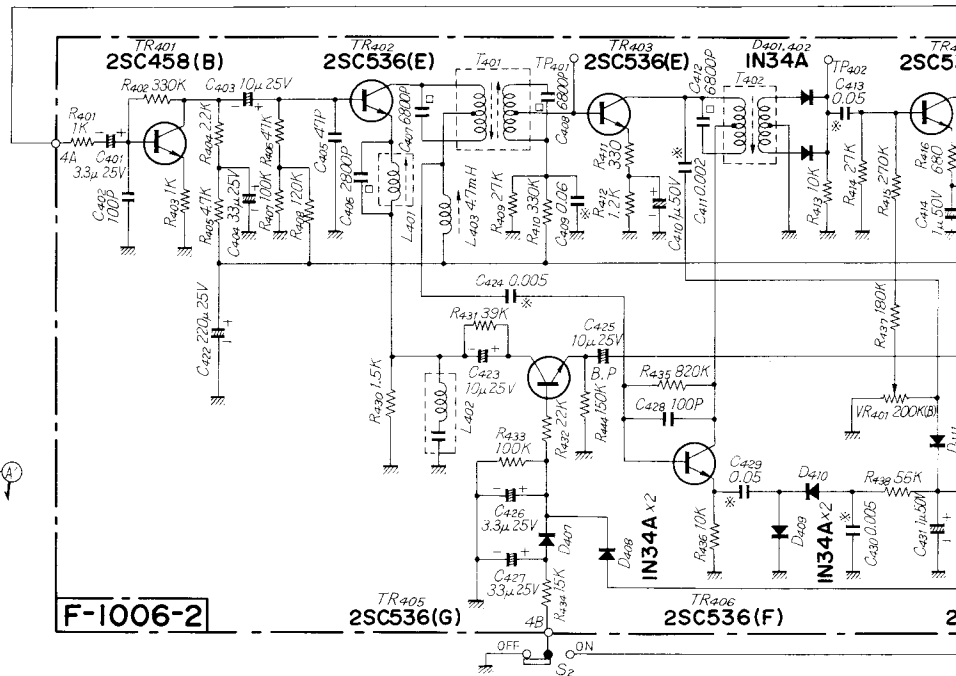
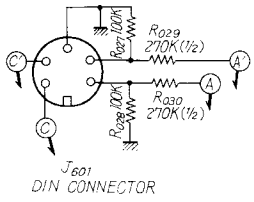

SCHEMATIC DIAGRAM

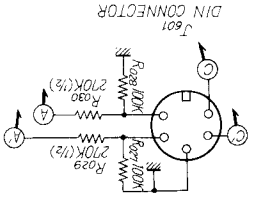

- SELECTORS (S₁-S₇)
1. PHONO 2
 2. PHONO 1
 3. AM
 4. FM MONO
 5. FM AUTO
 6. AUX
- S₁ MUTING
- S₂ FM STEREO ONLY
- S₃ TAPE MONITOR A
- S₄ TAPE MONITOR B
- S₅ REVERSE
- S₆ MONO
- S₇ LOUDNESS
- S₈ HIGH FILTER
- S₉ LOW FILTER
- S₁₀ SPEAKERS SELECTOR
- A, B, C A+B A+C

F-1006-2

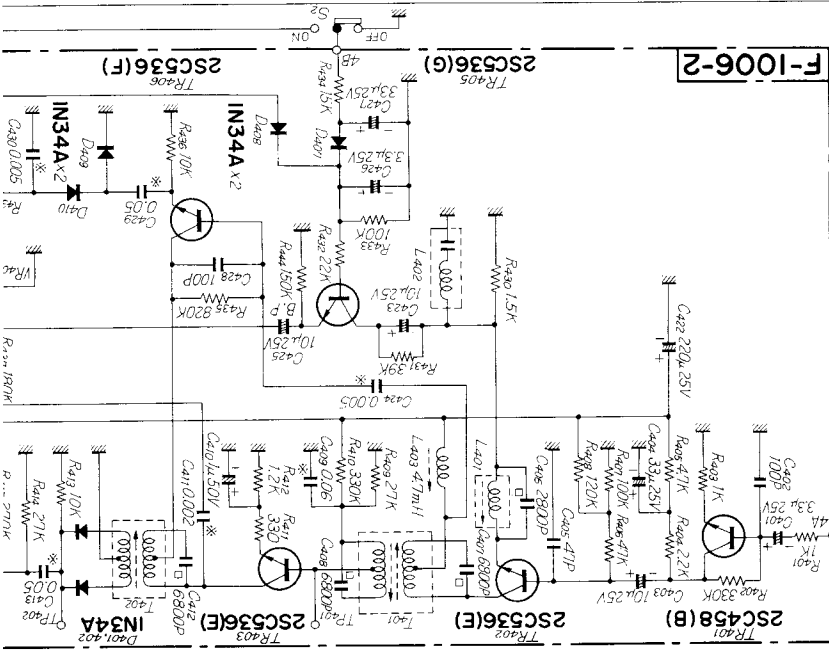

F-1038-5

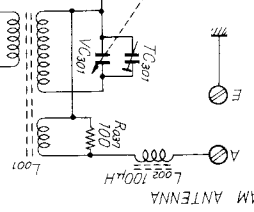
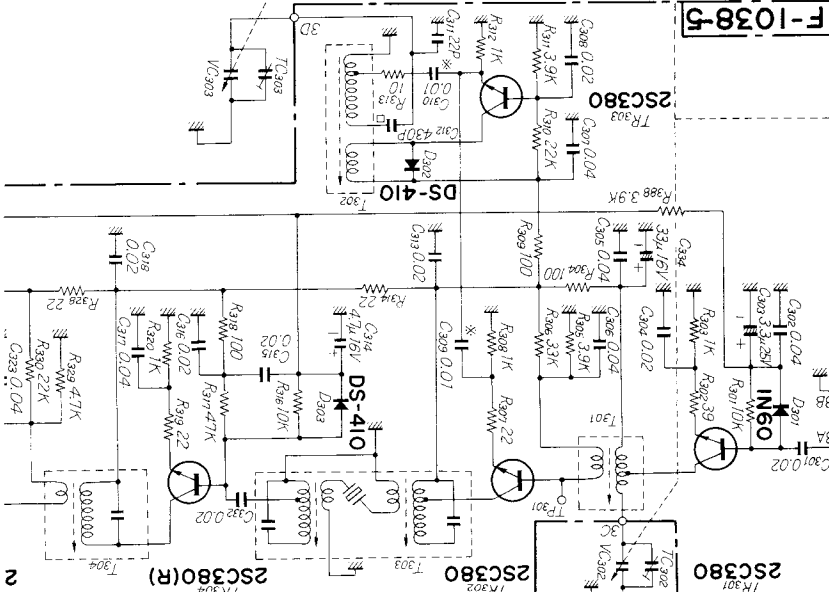

F-1085B

