

SERVICE MANUAL

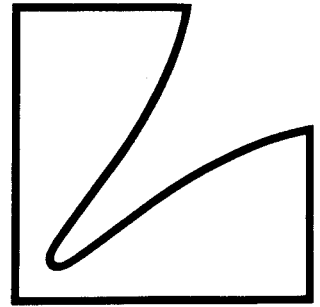

AM/FM STEREO
DC TUNER-AMPLIFIER **R-1070**

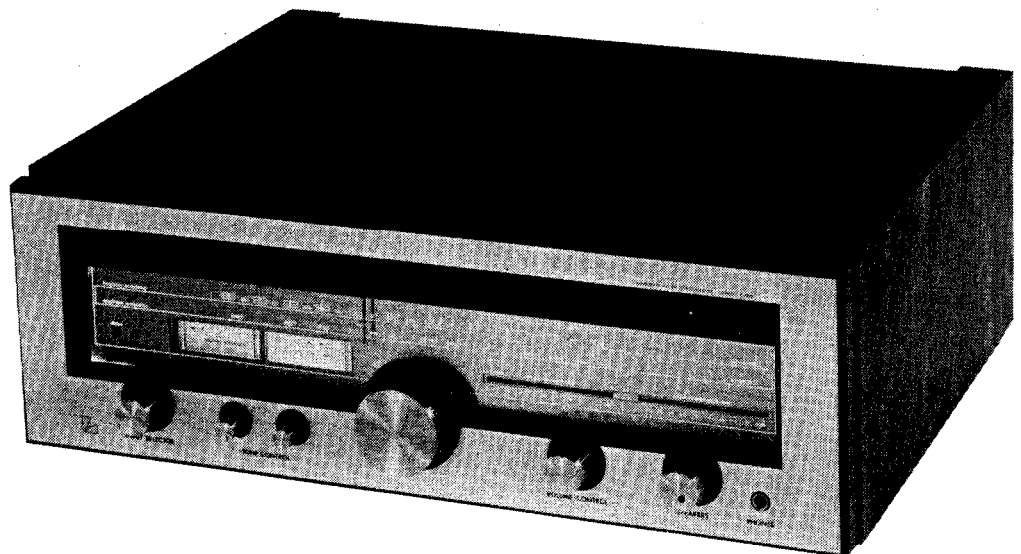

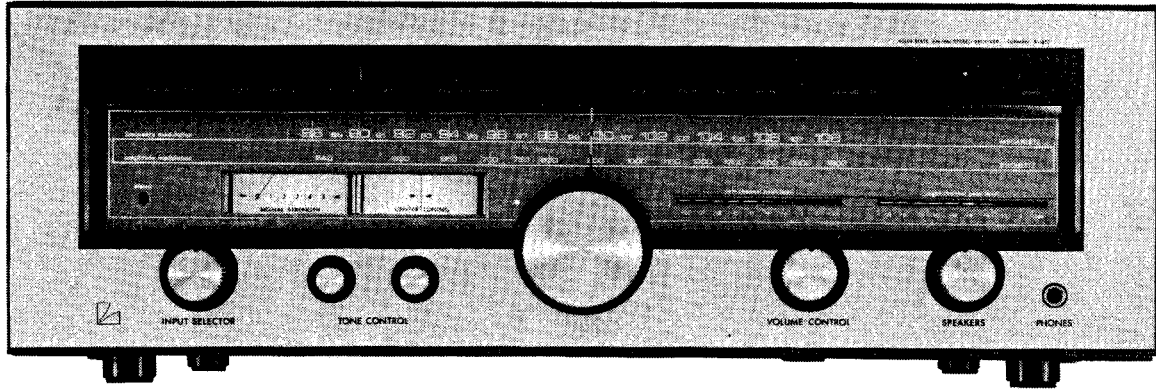

RL070 ALIGNMENT PROCEDURE (RF Section)

- | Step | Process |
|---------------|---|
| 1. Connection | Connect the "REC out" terminal at the back panel with the milli-volt meter, distortion meter, and synchroscope. Also connect the FM SG (FM Signal Generator) and stereo signal operator to the FM antenna terminal. |

Set each control on the front panel:
Function switch at the "FM" position.
IF selector at the "wide" position.
Muting switch at the "off" position.
Dolby FM switch (if provided) at the "off" position.

2. Set the semi-fixed volumes on the RF board as follows.

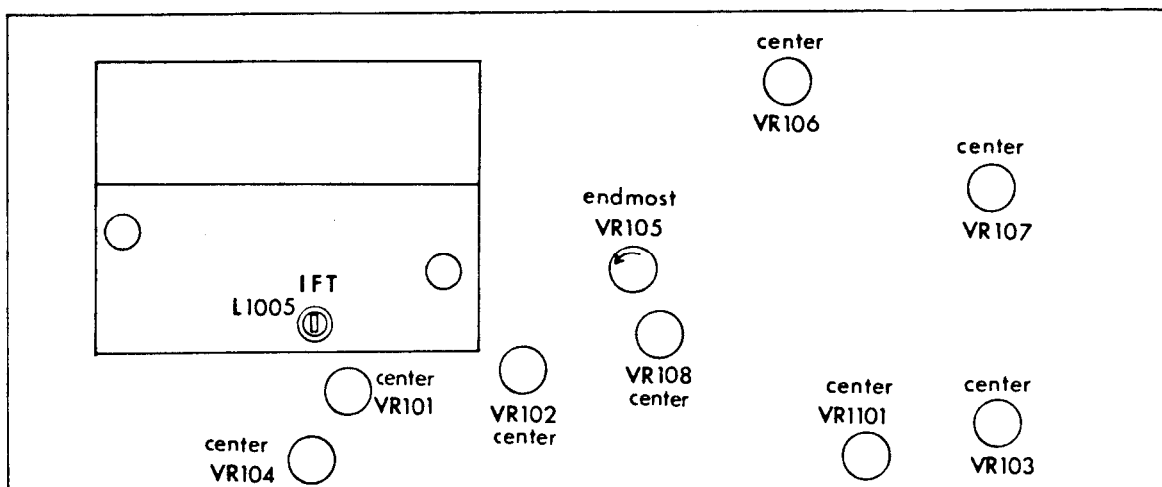

3. Frontend and IF Alignment
- Confirm the de-emphasis : S type 50uS, U type 75uS
 - Confirm that the dial pointer starts at the correct point and moves smoothly on the dial plate.
 - Set the dial pointer at the point having no broadcast station and receive an inter-station noise. Adjust the T102 to read "0" on the center meter.
 - Set the FM SG to 108MHz, output 1mV, mono 400Hz 100% modulation.
 - Set the dial pointer at 108MHz to obtain 400Hz signal at the REC out terminal.
 - Reduce the output of FM SG, and confirm that noise is overlapped symmetrically on the output wave-form of 400Hz. Reduce the output down to about 1.5uV.
 - Adjust the trimmer of oscillator to receive the above signal correctly.
 - Adjust the antenna, 3 inter-stage trimmers at the frontend one by one to obtain the maximum output at the REC out terminal.

- i. Set the FM SG to 87.5MHz, output 1.5uV, mono 400Hz 100% modulation.
- j. Set the dial pointer at 87.5MHz, and confirm that above signal is received within the width of the dial pointer.
- k. Repeat the steps (d)-(j) 2 or 3 times to obtain the max. sensitivity and the min. dial calibration error. Then, adjust the frontend IFT L1005 to get the max. output.
- l. Set the FM SG to 98MHz, output 20uV, 1KHz 100% modulation, and adjust the VR104 to obtain the swing of the signal strength meter at "0.7".
- m. Change the output to 1mV, and adjust the VR105 to obtain "4.5" reading on the signal meter. Then switch off the FM SG and confirm that the signal meter shows the zero position.
- n. Set the IF selector switch at the "narrow" position, and adjust the VR101 as per the step (m).
- o. Increase the output of FM SG gradually in the order of 20uV, 500uV and 1mV, and confirm that no change takes place in the signal strength meter by inter-switching the IF selector between the "narrow" and "wide" positions.
- p. Set the IF selector at the "wide" position and fix the output of FM SG at 10uV. Then turn on the muting switch, and adjust the VR108 at the point where the output signal is available at the REC out terminal.
- q. Set the FM SG to 1mV output, 400Hz 100% modulation, and adjust the T101 to obtain the minimum distortion.
- r. Reduce the FM SG output to the minimum, and adjust the T102 to obtain the "0" indication of the pointer at the center meter.
- s. Repeat the steps (q) and (r).

4. FM MPX Alignment

- a. Set the FM SG to 1mV output, no modulation.
- b. Connect a frequency counter at the pin No. 112 and adjust the VR103 to obtain $76\text{KHz} \begin{matrix} + 0 \\ - 10 \end{matrix}$ Hz on the frequency counter.
- c. Set the FM SG to 1mV output, 1KHz 100% stereo modulation.
- d. Adjust the VR107 to obtain the balanced max. separation between the right and left channels.
- e. Adjust the VR102 to get the minimal distortion.
- f. Confirm that the stereo indicator lights up.
- g. As the last step, adjust the VR1101 to obtain $1\text{V} \pm 10\%$ at the REC out terminal.

5. Anti-birdie Alignment (S type only)

- a. The anti-birdie filter does not need adjustment in principle, and confirm only the frequency response.
- b. The output of the anti-birdie filter :

1KHz	0dB
60KHz	-0.5dB
70KHz	-11dB

6. AM Section

- a. Set the AM-FM switch to AM position.
- b. Connect the output of 455KHz Sweep Generator (SPG) to the No. 130 terminal.
- c. Connect the SPG input to the No. 129 terminal.
- d. Set the SPG to "output 40-50dB, sweep speed 5-10Hz".
- e. Adjust the T104 and T105 so that the IF wave-form can be symmetrical and that the output can be maximum. It is suggested that the dial pointer sets to the 1,600KHz.
- f. Disconnect the SPG.
- g. Tune in to 600KHz and 1,400KHz on the dial scale by adjustment of the local OSC trimmer and core.
- h. Adjust the bar-antenna and the antenna trimmer to obtain the maximum output of tuner at 600KHz and 1,400KHz.
- i. Set the output of AM SG at 100dB/m and adjust VR106 so that the signal strength meter swings to 4 1/2. (ANT-IN 100dB/m)

EXPLODED VIEW

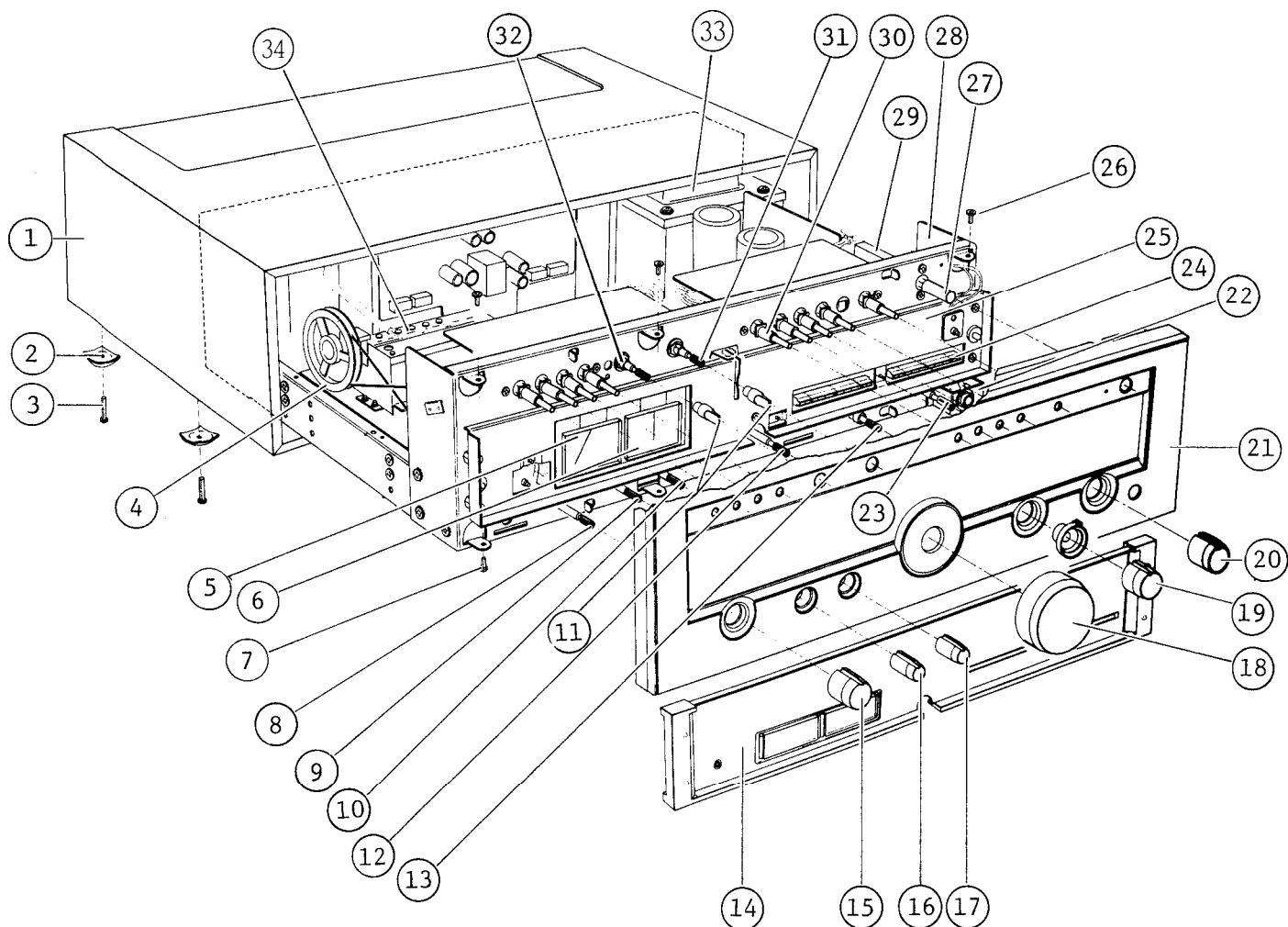

R-1070 EXPLODED VIEW PARTS LIST

1. WB1063	Wooden Case	23. SR0083	Rotary Sw (SP Select)
2. UR1125	Fixing Metal	24. TD0149B	LED LD002RB x 4
3.	Screw 4x20	TD0150B	LED LD003RB x 4
4. BX0040	Dial Drum	25. UR1141	Fixing Metal
5. AM0040	Signal Meter	26.	Screw 4x10
6. AM0039	Tuning Meter	27. WJ1066	Mould Knob (Power)
7.	Screw 4x10 black	28. UB1033	Sub Panel
8. SR0111	Rotary Sw (Input Select.)	29. SP0113	Push Sw (Power) (U)
9. RV0103	Bass Control 100kB	SP0114	Push Sw (Power) (E) (S)
10. RV0096	Treble Control 50kB	30. WJ1069	Mould Knob x 9
11. WJ1067	Mould Knob (mode, dubbing)	31. SR0087	Rotary Sw (Mode)
12. UX1003	Fly-Wheel	32. SR0088	Rotary Sw (Dubb.)
13. RV0094	Main VR 50kBx2+100kBx2	33. PT2332	Power Transformer (E)
14. WM1045	Dial Scale	PT2334	Power Transformer (U)
15. WH1033	Knob (Input Select.)	PT2335	Power Transformer (S)
16. WH1039	Knob (Tone Cont.)	34. LA1908	Frontend
17. WH1039	Knob (Tone Cont.)	-- UC1107	Rear Panel (E) (U)
18. WH1035	Knob (Tuning)	UC1108	Rear Panel (S)
19. WH1039	Knob (Main VR)	-- BU0069	Leg
20. WH1033	Knob (SP Select.)	-- BE1063	Heat Sink
21. WA1140	Front Panel	-- SP0077	Push Sw (Muting, Monitor etc)
22. AJ0015	Headphone Jack	-- SP0076	Push Sw (Filters)

Replacement Parts List

Remarks

Capacitors: C.....Ceramic, E.....Electrolytic, M.....Mylar, G.....G Capacitor
 S.....Styrol, T.....Tantalum, Mi.....Mica, MP.....MP Capacitor
 O.....Oil capacitor, TRIM.....Trimmer capacitor, AC.....AC Capacitor
 BP.....Electrolytic Bi-Polar type

Resistors: ±10%, ±5%, 1/4W, unless specified otherwise

Type: (S).....Model for north European countries
 (U).....Model for U.S.A. and CANADA
 (E).....Standard model
 (J).....Model for JAPAN

PB1227

SYMBOL NO.	STOCK NO.	DESCRIPTION	LOCATION
051	CC0002	3.3pF +10% -10% 50V C	Y2
052	CE0074	10µF +50% -10% 16V E	Y2
063	CK0158	0.047µF +80% -20% 25V C	X3
064	CK0158	0.047µF +80% -20% 25V C	X4
C101	CK0155	0.01µF +80% -20% 50V C	Y1
102	CK0158	0.047µF +80% -20% 25V C	Y1
103	CK0158	0.047µF +80% -20% 25V C	Y1
104	CK0158	0.047µF +80% -20% 25V C	Y1
105			
106	CK0155	0.01µF +80% -20% 50V C	Y2
107	CK0158	0.047µF +80% -20% 25V C	Y2
108	CK0158	0.047µF +80% -20% 25V C	Y2
109	CK0158	0.047µF +80% -20% 25V C	Y2
110	CK0158	0.047µF +80% -20% 25V C	Y2
111	CC0130	6.8pF +10% -10% 50V C	Y2
112	CK0155	0.01µF +80% -20% 50V C	Y2
113	CK0155	0.01µF +80% -20% 50V C	Y3
114	CK0158	0.047µF +80% -20% 25V C	Y3
115	CK0158	0.047µF +80% -20% 25V C	Y3
116	CK0158	0.047µF +80% -20% 25V C	Y3
117	CK0158	0.047µF +80% -20% 25V C	Y3
118	CK0158	0.047µF +80% -20% 25V C	Y3
119	CK0158	0.047µF +80% -20% 25V C	Y3
120	CC0007	100pF +10% -10% 50V C	Y3
121	CQ0079	470pF + 5% - 5% 50V S	Y4
122	CQ0009	0.047µF +10% -10% 50V M	Y4
123	CQ0079	470pF + 5% - 5% 50V S	Y4
124	CE0168	3.3µF +75% -10% 50V E	Y4
125	CE0095	1µF +75% -10% 50V E	Y4
126	CS0019	0.22µF +20% -20% 50V T	Y4
127	CE0099	2.2µF +75% -10% 50V E	Y3
128	CE0099	2.2µF +75% -10% 50V E	Y3
129	CK0155	0.01µF +80% -20% 50V C	Y1
130	CK0158	0.047µF +80% -20% 25V C	Y1
131	CK0155	0.01µF +80% -20% 50V C	Y1
132	CK0155	0.01µF +80% -20% 50V C	Y1
133	CK0158	0.047µF +80% -20% 25V C	Y1
134	CK0158	0.047µF +80% -20% 25V C	Y1
135	CK0155	0.01µF +80% -20% 50V C	Y2
136	CE0099	2.2µF +75% -10% 50V E	Y2
137	CK0158	0.047µF +80% -20% 25V C	Y3
138	CK0158	0.047µF +80% -20% 25V C	Y3
139	CK0158	0.047µF +80% -20% 25V C	Y3
140	CE0099	2.2µF +75% -10% 50V E	Y3
141	CE0079	220µF +50% -10% 16V E	Y3
142			
143	CC0013	15pF +10% -10% 50V C	X2
144	CQ0172	330pF + 5% - 5% 50V S	X2
145	CC0004	22pF +10% -10% 50V C	X2
146	CK0158	0.047µF +80% -20% 25V C	Y2

SYMBOL NO.	STOCK NO.	DESCRIPTION	LOCATION
C147	CE0079	220µF +50% -10% 16V E	Y2
148	CK0158	0.047µF +80% -20% 25V C	Y1
149	CK0158	0.047µF +80% -20% 25V C	Y1
150	CK0158	0.047µF +80% -20% 25V C	Y1
151	CK0158	0.047µF +80% -20% 25V C	Y1
152	CK0158	0.047µF +80% -20% 25V C	Y1
153	CE0075	22µF +50% -10% 16V E	Y4
154	CK0156	0.022µF +80% -20% 25V C	X3
155	CK0156	0.022µF +80% -20% 25V C	X3
156	CK0126	0.001µF +20% -20% 50V C	X3
157	CK0158	0.047µF +80% -20% 25V C	X3
158	CK0156	0.022µF +80% -20% 25V C	X2
159	CK0126	0.001µF +20% -20% 50V C	X3
160	CE0075	10µF +50% -10% 16V E	X3
161	CE0168	3.3µF +75% -10% 50V E	X3
162	CK0155	0.01µF +80% -20% 50V C	X3
163	CQ0157	0.018µF +10% -10% 50V M	X4
164	CQ0013	0.022µF +10% -10% 50V M	X4
165	CQ0025	0.0012µF +10% -10% 50V M	X4
166	CE0079	220µF +50% -10% 16V E	X3
167	CK0158	0.047µF +80% -20% 25V C	X3
168	CE0074	10µF +50% -10% 16V E	X3
169	CK0156	0.022µF +80% -20% 25V C	X3
170	CE0213	0.47µF +75% -10% 50V E	X4
171			
172			
173			
174			
175			
176			
177			
178	CS0019	0.22µF +20% -20% 50V S	X3
179	CE0084	4.7µF +75% -10% 25V E	Y4
180	CS0019	0.22µF +20% -20% 35V T	X3
181	CE0075	22µF +50% -10% 16V E	Y4
182	CE0084	4.7µF +75% -10% 25V E	X4
183	CQ0218	750pF + 5% - 5% 50V S	X4
184	CQ0218	750pF + 5% - 5% 50V S	X4
185			
186	CE0084	4.7µF +75% -10% 25V E	X4
187	CQ0218	750pF + 5% - 5% 50V S	X4
188	CQ0213	750pF + 5% - 5% 50V S	X4
189	CE0075	22µF +50% -10% 16V E	Y4
190	CK0158	0.047µF +80% -20% 25V C	X4
C191	CE0087	220µF +50% -10% 25V E	X4
192	CE0079	220µF +50% -10% 16V E	X4
193	CE0079	220µF +50% -10% 16V E	Y4
194	CE0090	1000µF +50% -10% 25V E	X4
195	CE0090	1000µF +50% -10% 25V E	Y4
196	CK0158	0.047µF +80% -20% 25V C	Y4
199	CK0158	0.047µF +80% -20% 25V C	Y2

SYMBOL NO.	STOCK NO.	DESCRIPTION	LOCATION
C1201	CK0155	0.01 μ F +80% -20% 50V C	Y4
1202	CQ0218	750pF + 5% - 5% 50V S	X4
1203	CQ0218	750pF + 5% - 5% 50V S	Y4
1204	CK0155	0.01 μ F +80% -20% 50V C	Y4
1207	CE0074	10 μ F +50% -10% 16V E	Y1
1208	CK0153	0.047 μ F +80% -20% 25V C	Y1
1101	CE0075	22 μ F +50% -10% 16V E	Y3
1102	CE0075	22 μ F +50% -10% 16V E	Y3
1103	CK0109	470pF +10% -10% 50V C	Y3
1104	CE0213	2.2 μ F +75% -10% 50V E	Y3
1105	CK0158	0.047 μ F +80% -20% 25V C	Y3
R051	RB0134	10 Ω	Y4
052	RB0222	47K	Y4
053	RB0182	1K	Y1
054			
055	RB0206	10K x 2	Y4
056	RB0174	470 Ω	X2
057	RB0222	47K	Y4
R101	RB0174	470 Ω	Y1
102	RB0200	5.6K	Y1
103	RB0158	100 Ω	Y1
104	RB0170	330 Ω	Y1
105	RB0182	1K	Y1
106	RB0206	10K	Y1
107	RB0158	100 Ω	Y1
108	RB0174	470 Ω	Y1
109	RB0170	330 Ω	Y1
110	RB0198	4.7K	Y2
111	RB0222	47K	Y2
112	RB0166	220 Ω	Y2
113	RB0176	560 Ω	Y2
114	RB0198	4.7K	Y2
115	RB0182	1K	Y2
116	RB0166	220 Ω	Y2
117	RB0182	1K	Y2
118	RB0134	10 Ω	Y3
119	RB0172	390 Ω	Y3
120	RB0202	6.8K	Y3
121	RD0026	R 1/4 22K	Y3
122	RB0166	220 Ω	Y3
123	RB0158	100 Ω	Y3
124	RB0158	100 Ω	Y3
125	RB0206	10K	Y4
126		J	Y4
127	RB0230	100K	Y4
128	RB0182	1K	Y4
129	RB0174	470 Ω	Y4
130	RB0178	680 Ω	Y4
131	RB0194	3.3K	Y4
132	RB0194	3.3K	Y4
133	RB0182	1K	Y4
134	RB0194	3.3K	X3
135	RB0194	3.3K	X3
136	RB0194	3.3K	X3
137	RB0194	3.3K	X3
138	RB0214	22K	X3
139	RB0214	22K	X3
140	RB0206	10K	Y4
141	RB0230	100K	Y4
142	RB0222	47K	Y1
143	RB0148	100 Ω	Y2
144	RB0230	100K	Y1
145	RB0200	5.6K	Y1

SYMBOL NO.	STOCK NO.	DESCRIPTION	LOCATION
146	RB0182	1K	Y1
147	RB0210	15K	Y1
148	RD0029	12K R1/4	Y1
149	RB0182	1K	Y1
150	RB0206	10K	Y1
151	RB0174	470	Y1
152	RB0170	330	Y1
153	RB0198	4.7K	Y1
154	RB0198	4.7K	Y2
155	RB0222	47K	Y2
156	RB0166	220	Y2
157	RB0176	560	Y2
158	RB0158	100	Y1
159	RB0218	33K	Y2
160	RB0218	33K	Y3
R161	RB0206	10K	Y3
162	RD0043	R 1/4 1K	Y3
163	RD0222	47K	Y3
164	RD0039	R 1/4 2.2K	Y3
165	RD0069	R 1/3 10	Y3
166	RB0222	47K	Y3
167	RB0208	12K	Y3
168	RB0134	10	X3
169	RD0041	R 1/4 1.5K	X3
170	RB0170	330	X3
171	RB0206	10K	X3
172	RB0206	10K	X3
173	RB0192	2.7K	X3
174	RB0216	27K	X3
175	RB0234	150K	X4
176	RB0216	27K	X4
177	RB0172	390	X4
R178	RB0184	1.2K	X4
179			
180	RB0222	47K	X4
181	RB0222	47K	X3
R182	RB0230	100K	Y3
183	RB0230	100K	Y3
184	RB0206	10K	X4
185	RB0218	33K	X4
186	RB0206	10K	X4
187	RB0218	33K	X4
188	RD0039	R 1/4 2.2K	Y4
189	RB0218	33K	X4
190	RD0260	R-50 270	X4
191	RD0051	R 1/4 270	X4
192	RB0182	1K	X2
193	RB0188	1.8K	Y3
194	RB0218	33K	Y3
195	RB0200	5.6K	X3
196	RB0190	2.2K	Y4
197	RB0210	15K	Y1
198	RB0216	27K	Y1
199	RB0158	100	Y1
R1101	RB0206	10K	Y3
1102	RB0206	10K	Y3
1103	RB0206	10K	Y3
1104	RB0198	4.7K	Y3
1105	RB0206	10K	Y4
1106	RB0158	100	Y2

SYMBOL NO.	STOCK NO.	DESCRIPTION	LOCATION
Q101	TR0233	2SC535	Y1
102	TR0085	2SC1923	Y1
103	TR0085	2SC1923	Y2
104	TR0085	2SC1923	Y1
105	TR0085	2SC1923	Y1
106	TR0085	2SC1923	Y2
107	TR0198	2SC1815	Y2
108	TR0025	2SC1345	X4
109	TR0121	2SC1626	X4
110	TR0198	2SC1815	X3
111	TR0198	2SC1815	X3
	TR0025	2SC1345	Y3
	TR0198	2SC1815	Y4
IC101	TC0106	μPC1163H	Y2
102	TC0099	LA1231	Y3
103	TC0100	μPC1173	Y4
104	TC0021	HA1197	X3
105	TC5006	μPC4558C	Y4
D101	TD0116	1S2705	Y2
102	TD0116	1S2705	Y2
103	TV0004	KB265	Y2
104	TD0116	1S2705	Y2
105	TD0018	1K188-FM1	Y1
106	TD0018	1K188-FM1	Y1
107	TD0116	1S2705	X3
108	TD0079	WZ140	X4
109	TD0116	1S2705	Y4
110	TD0116	1S2705	X4
111	TD0137	SIVB10	Y4

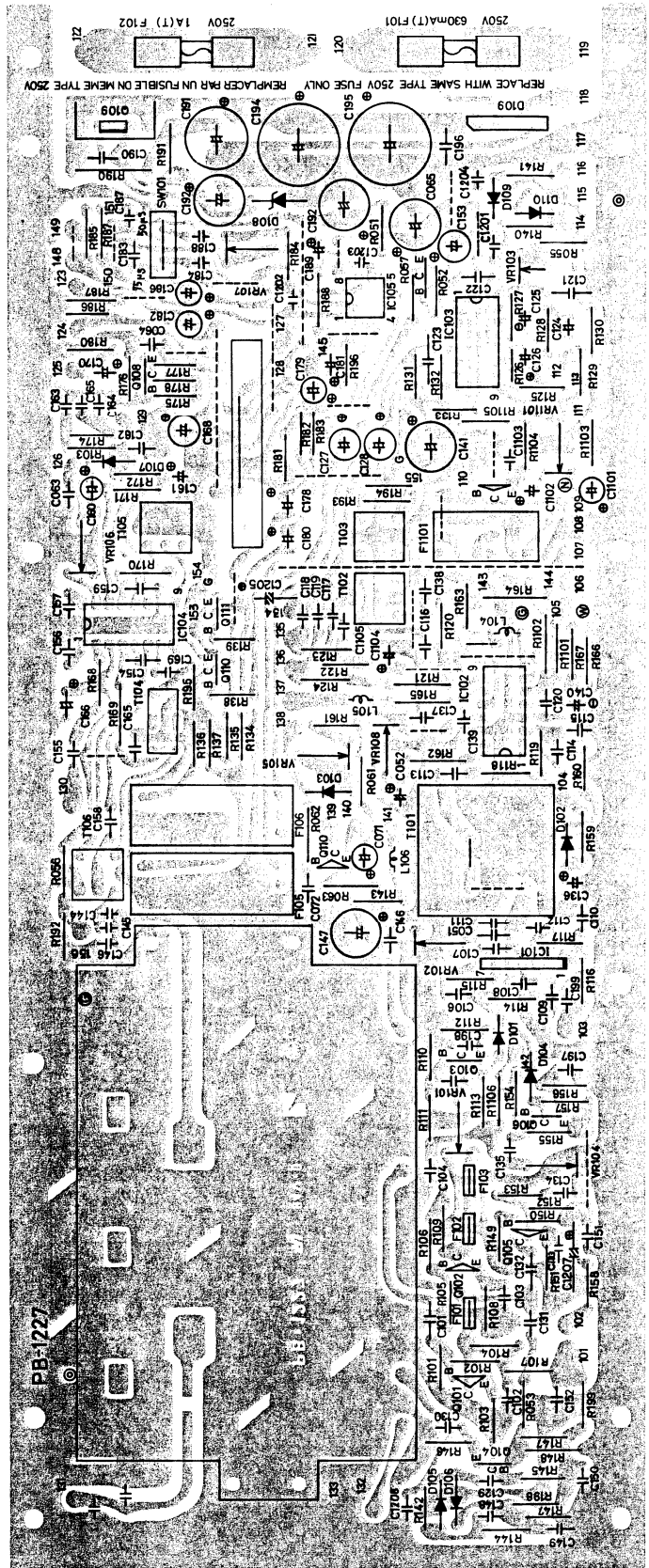

SYMBOL NO.	STOCK NO.	DESCRIPTION	LOCA-TION
C501ab	CE5019	1μF +75% -10% 50VECX	X2 X2
502ab	CC0007	100pF +10% -10% 50V S	X2 X2
503ab	CE0085	33μF +50% -10% 25V E	X2 X2
504ab	CE0102	47μF +50% -10% 50V E	X2 X2
505ab	CQ0611	0.22μF +10% -10% 100V P	X2 X2
506ab	CC0038	5pF +10% -10% 50V S	X2 X2
507ab	CQ0180	33pF + 5% - 5% 125V S	X2 X2
508ab	CK0183	0.001μF +10% -10% 50V S	X2 X2
509ab	CK0126	0.001μF +20% -20% 50V S	Y2 Y2
510ab	CE0107	47μF +50% -10% 63V E	X2 X2
511ab	CQ0124	0.022 + 5% - 5% 50V M	X3 X1
512ab	CE0077	33μF +50% -10% 16V E	X3 X1
513ab	CE0076	33μF +50% -10% 16V E	X3 X1
514ab	CK0109	470pF +10% -10% 50V S	X3 X1
515ab	CK0109	470pF +10% -10% 50V S	X3 X1
516ab	CK0203	0.01μF +20% -20% 500V S	X3 X1
617ab	CQ0613	0.1μF +10% -10% 100V P	X2 X2
518ab	CQ5008	0.1μF +10% -10% 250V P	X3 X1
519	CE0096	220μ +50% -10% 25V E	X2
520	CE0118	47μF +50% -10% 25V E	X2
521	CE0079	220μF +50% -10% 16V E	X2
522	CE0079	220μF +50% -10% 16V E	X2
523	CE0086	10μF +50% -10% 25V E	X2
524	CE0086	10μF +50% -10% 25V E	X2
526ab	CK0073	100pF +10% -10% 500V S	X3 X1
R501ab	RD0022	47K	Y2 Y2
502ab	RD0038	2.7K	Y2 Y
503ab	RD0038	2.7K	X2 X2
504ab	RD0025	27K	X2 X2
505ab	RD0037	3.3K	Y2 Y2
506ab	RD0022	47K	Y2 Y2
507ab	RD0039	2.2K	Y2 Y2
508ab	RD0025	27K	Y2 Y2
509ab	RD0026	22K	Y2 Y2
510ab	RD0039	2.2K	Y2 Y
511ab	RD0029	12K	Y2 Y2
512ab	RD0032	8.2K	Y2 Y2
513ab	RD0023	39K	Y2 Y2
514ab	RD0134	R50 470	Y2 Y2
515	RD0032	8.2K	Y2 Y2
516ab	RS1586	F50 1.5K	X3 X1
517ab	RS1568	F50 270	Y2 Y2
518ab	RS0074	F50 100	Y2 Y2
519ab	RD0062	39	Y2 Y2
520ab	RD0259	R50 47K	X3 X1
521ab	RS0067	F1/4 150	X3 X1
522ab	RD0040	1.8K	X3 X1
523ab	RD0047	560	X3 X1
524ab	RD0045	820	X3 X1
525b	RD0045	820	X3 X1
526ab	RS1556	F50 220	X3 X1
527ab	RS1556	F50 220	X3 X1
528ab	RD0021	56K	X3 X1
529ab	RD0021	56K	X3 X1
530ab	RD0037	3.3K	X3 X1
531ab	RD0037	3.3K	X3 X1
532ab	RG0001	0.33 5WCS	X3 X1
533ab	RG0001	0.33 5WCS	X3 X1
534 b	RS1534	F50 10	X3 X1
535ab	RS5004	10 2W	X2 X2
536ab	RS0201	4.7 2W	X2 X2
537ab	RS5005	680 2W	X2 X2
R538	RD0014	180K	X2
539	RD0034	5.6K	X2
540	RD0043	1K	X2
541	RD0032	8.2K	X2
542	RD0043	1K	X2
543	RD0037	3.3K	X2

SYMBOL NO.	STOCK NO.	DESCRIPTION	LOCA-TION
544	RS1092	F1/4 2.2K	Y2
545	RD0004	1M	X2
546	RD0004	1M	X2
547	RD0023	39K	X2
548		68K	X2
549	RD0039	2.2K	X2
550			
551	RD0025	27K	X2
552	RD0025	27K	X2
Q501ab	TR0146	2SC1740	Y2 Y2
502ab	TR0146	2SC1740	Y2 Y2
503ab	TR5003	2SA798G	Y2 Y2
504ab	TR0218	2SA872	Y2 Y2
505ab	TR0218	2SA872	Y2 Y2
506ab	TR0090	2SD756	Y2 Y2
507ab	TR0090	2SD756	Y2 Y2
508ab	TR0197	2SB716	X3 X1
509ab	TR0165	2SC1775	X3 X1
510ab	TR0218	2SA872	X3 X1
511ab	TR0165	2SC1775	X3 X1
512ab	TR0241	2SA1006	X3 X1
513ab	TR0242	2SC2336	X3 X1
514	TR0269	2SB705	Power Tr
515	TR0270	2SD745	Power Tr
516	TR0001	2SC734	X2
517	TR0146	2SC1740	X2
518	TR0148	2SA826	X2
519	TR0146	2SC1740	X2
520	TR0146	2SC1740	X2
521	TR0165	2SC1775	X2
522	TR0165	2SC1775	Y2
D501ab	TD0141	BZ-340	X2 X2
502ab	TV0004	KB265	X3 X1
503ab	TD0069	1N4448	X3 X1
504ab	TD0069	1N4448	X3 X1
505ab	TD0069	1N4448	X3 X1
506ab	TD0069	1N4448	X3 X1
507	TD0001	1N4002	X2
508	TD0002	1N4001	X2
509	TD0073	WG713	X2
510	TD0073	WG713	X2
511	---		
512	---		
513	---		
514	TD0073	WG713	X2

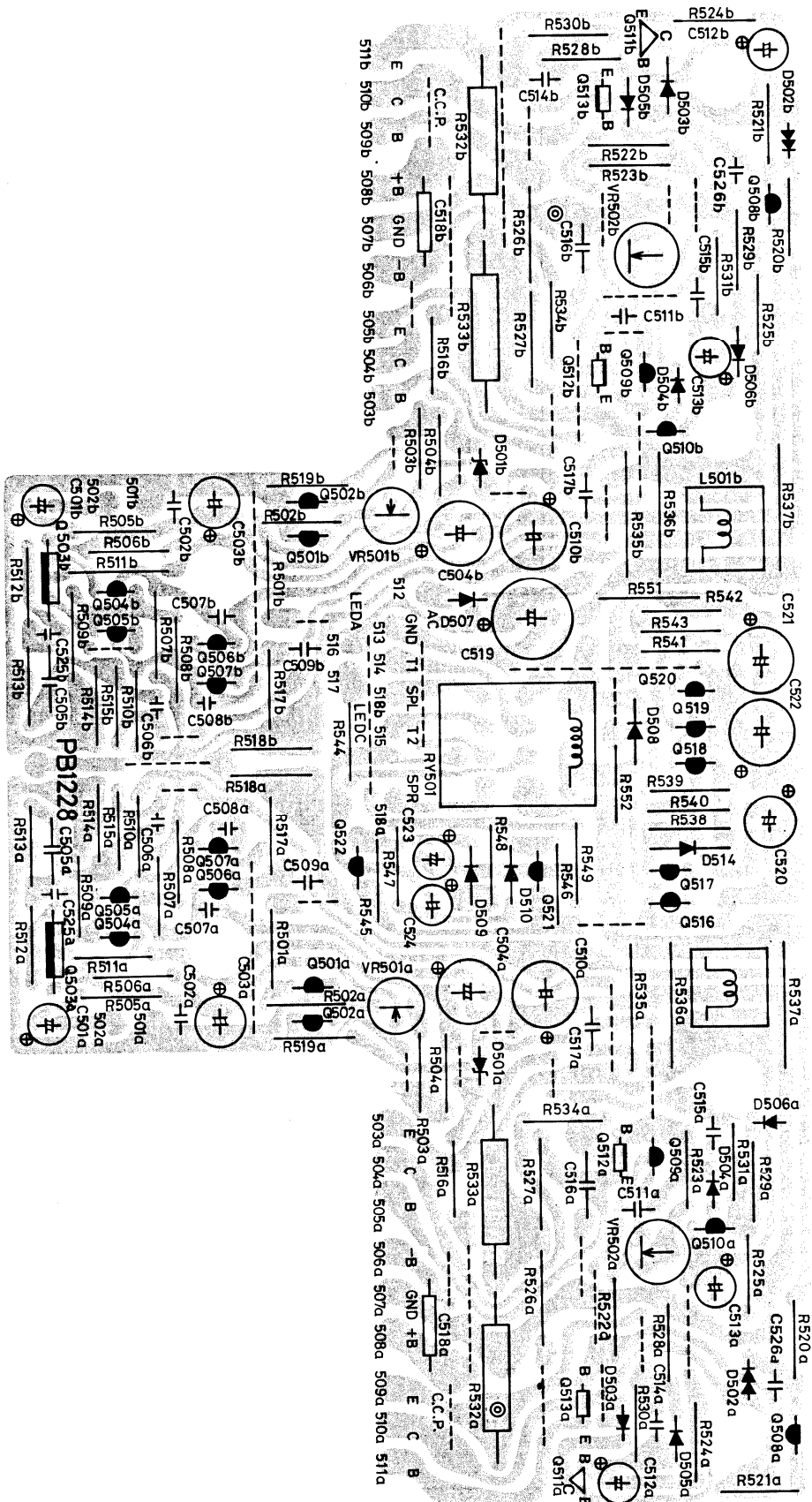

SYMBOL NO.	STOCK NO.	DESCRIPTION	LOCATION
C201	CE0080	470μF +50% -10% 16V E	
202	CE0110	47μF +50% -10% 100V E	
203	CE0107	47μF +50% -10% 63V E	
204	CE0110	100μF +50% -10% 100V E	
205	CK0203	0.01μF +80% -10% 500V S	
206	CU0013	0.01μF 250V P	
207	CU0013	0.01μF 250V P	
208	CU0013	0.01μF 250V P	
209	CU0013	0.01μF 250V P	
210	CU0013	0.01μF 250V P	
R201	RD0127	2.2K 1/2	
202	RD0133	560 1/2	
203	RD0020	68K 1/4	
204	RS3078	100 2W FP	
D201	TD0098	IN4758A	
202	TD0139	S1VB20	
203	TD0106	S3V40	
204	TD0106	S3V40	
205	TD0106	S3V40	
206	TD0106	S3V40	
207	TD0106	S3V40	
Q201	TR0241	2SA1006	

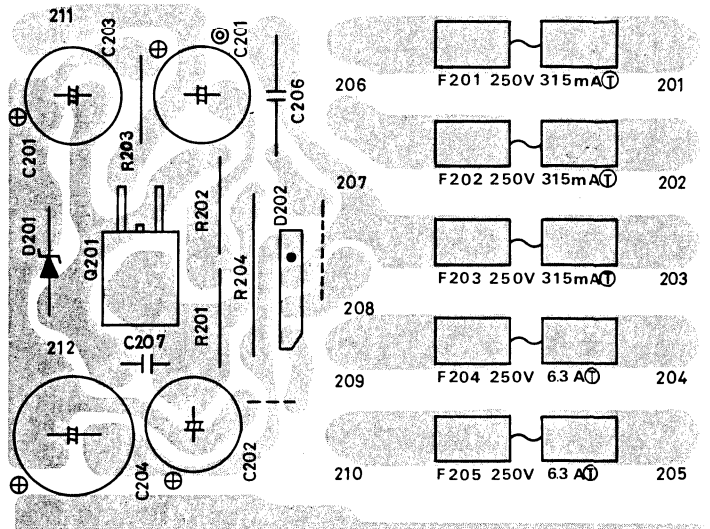

PB-1229

6721V

REPLACE WITH SAME TYPE 250V FUSE ONLY

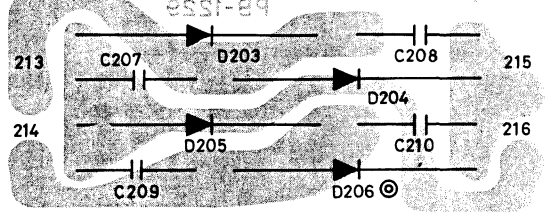

SYMBOL NO.	STOCK NO.	DESCRIPTION	LOCATION
C301ab	CE5025	3.3μF +75% -10% 50VECX	X4 Y4
302	CK0155	0.01μF +80% -20% 50V C	X3 Y4
303	CE0078	100μF +75% -10% 16V E	X3 Y4
304ab	CE5025	3.3μF +75% -10% 50VEXC	X3 Y3
305ab	CQ0031	0.033μF + 5% - 5% 50V M	Y2 Y1
306ab	CQ0130	0.001μF + 5% - 5% 50V M	Y2 Y1
307ab	CQ0130	0.001μF + 5% - 5% 50V M	Y2 Y1
308ab	CQ0177	0.0027μF + 5% - 5% 50V M	Y3 Y1
309	CE5025	3.3μF +75% -10% 50VECX	Y2 Y2
310b	CE0145	100μF +50% -10% 25V E	Y3 Y1
311ab	CE5019	1μF +75% -10% 50VECX	X2 Y1
313	CE0107	47μF +50% -10% 63V E	X1
314	CE0107	47μF +50% -10% 63V E	X2
R301	RB0246	470K R-25	X4 X4
302	RB0254	1M R-25	X4 Y4
303	RB0192	2.7K R-25	X4 X4
304	RB0212	18K R-25	X4 Y4
305	RB0222	47K R-25	X3 Y4
306	RB0212	18K R-25	X3 Y4
307	RB0169	300 R-25	X3 Y4
308	RB0192	2.7K R-25	X3 Y4
309	RB0214	22K R-25	Y3 Y3
310	RB0192	2.7K R-25	Y3 Y3
311	RB0194	3.3K R-25	Y3 Y1
312	RB0194	3.3K R-25	Y2 Y1
313	RB0186	1.5K R-25	Y2 Y1
314	RB0212	18K R-25	Y3 Y1
315	RB0182	1K R-25	X2 X2
316	RB0212	18K R-25	X2 Y1
317	RB0218	33K R-25	X2 Y1
318	RB0246	470K R-25	Y2 Y1
319	RB0168	270 R-25	X3 X1
320	RB0200	5.6K R-25	X3 X1
321	RB0200	100 R-25	X1 X1
322	RS1230	390 1/4M	X1
323	RS1227	220 1/4M	X1
324			
Q301	TR0125	2SA836	X4 Y4
302	TR0174	2SC1345	X4 Y4
303	TR0125	2SA836	X2 X2
304	TR0125	2SA836	X2 X2
305			
306			
307			

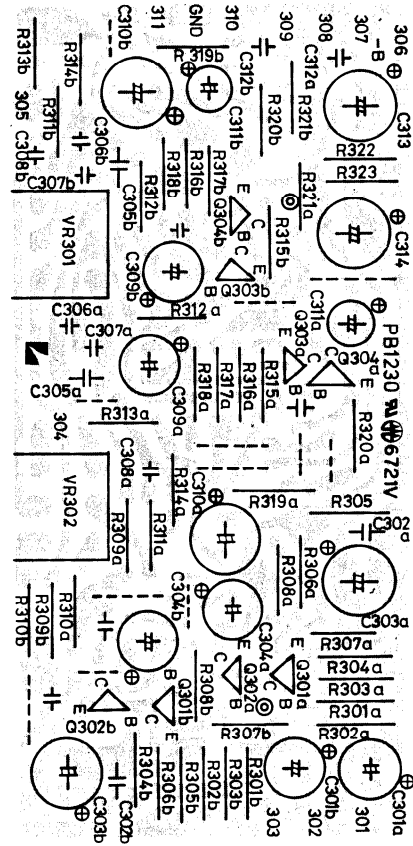

SYMBOL NO.	STOCK NO.	DESCRIPTION	LOCATION
C601	CK0146	0.04μF +80% -20% 50V C	Y1
602	CK0146	0.04μF +80% -20% 50V C	Y1
603	CE0250	100μF +50% -10% 35V E	Y2
604	CE0250	100μF +50% -10% 35V E	Y4
605	CK0146	0.04μF +80% -20% 50V C	X4
606	CK0146	0.04μF +80% -20% 50V C	Y3
607	CK0146	0.05μF +80% -20% 50V C	Y3
608	CK0146	0.04μF +80% -20% 50V C	X3
609	CQ0018	0.0056 +10% -10% 50V M	X2
610	CQ0018	0.0056 +10% -10% 50V M	X2
611	CK0146	0.04μF +80% -20% 50V C	Y2
R601	RS2715	330 1WFP	Y3
602	RS2715	330	Y3
603	RS2715	330	Y2
604	RS2715	330	X4
605	RS2527	1.8K 1/2FP	Y3
606	RB0196	3.9K R-25	X3
607	RB0210	15K R-25	X4
608	RD0119	3.3K R-50	X3
609	RD0119	3.3K R-50	X3
610	RD0119	3.3K R-50	X3
611	RD0119	3.3K R-50	Y3
612	RD0119	3.3K R-50	X3
613	RD0119	3.3K R-50	X4
614	RD0119	3.3K R-50	X4
615	RD0119	3.3K R-50	X4
616	RD0119	3.3K R-50	X4
617	RD0119	3.3K R-50	X4
618	RB0196	3.9K R-25	X1
619	RB0210	15K R-25	X2
620	RD0119	3.3K R-50	X1
621	RD0119	3.3K R-50	X1
622	RD0119	3.3K R-50	X1
623	RD0119	3.3K R-50	X1
624	RD0119	3.3K R-50	X1
625	RD0119	3.3K R-50	X2
626	RD0119	3.3K R-50	X2
627	RD0119	3.3K R-50	X2
628	RD0119	3.3K R-50	X2
629	RD0119	3.3K R-50	X2
630	RB0198	4.7K R-25	X3
631			
632	RB0202	6.8K R-25	X1
633	RB0208	12K R-25	X1
634	RB0208	12K R-25	X1
IC601	TC0101	TA7318P-1	X2
602	TC0102	TA7612P	X3
603	TC0102	TA7612P	X1
D601	TD0002	1N4002	Y1
602	TD0002	1N4002	Y1
603	TD0059	BZ192	Y3
604	TD5006	BZ130	Y2
605	TD5006	BZ130	X4
606	TD0060	WZ061	Y3

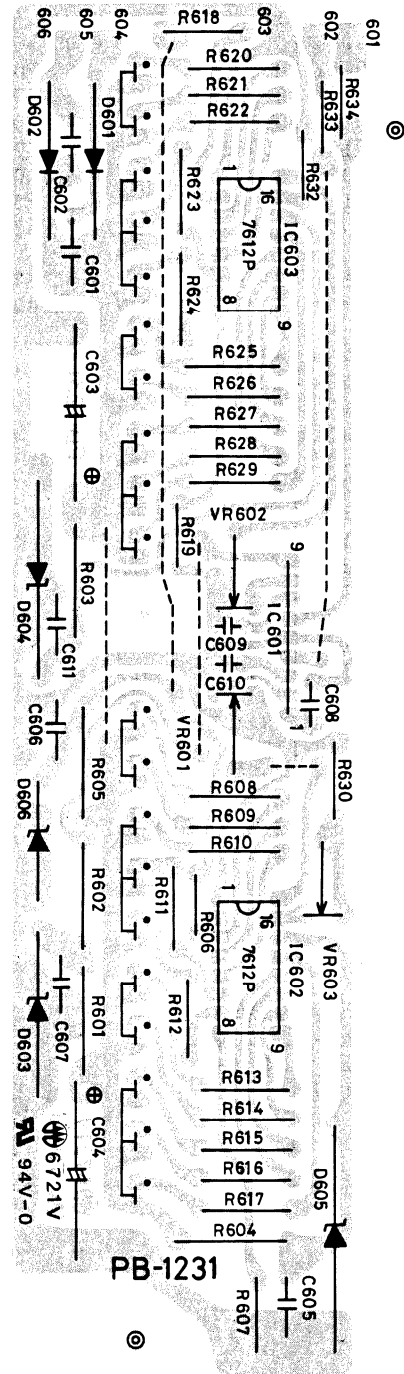

SYMBOL NO.	STOCK NO.	DESCRIPTION	LOCATION
R701	RB0254	1M R-25	X2
702	RB0254	1M R-25	X2
703	RB0254	1M R-25	X2
704	RB0254	1M R-25	Y2
705	RB0200	5.6K R-25	X1
706	RB0200	5.6K R-25	Y1

SYMBOL NO.	STOCK NO.	DESCRIPTION	LOCATION
C801	CQ0021	0.0033μF +10% -10% 50V M	Y3
802	CQ0021	0.0033μF +10% -10% 50V M	Y3
803	CQ0009	0.047μF +10% -10% 50V M	Y3
804	CQ0009	0.047μF +10% -10% 50V M	X4
805	CQ0006	0.082μF +10% -10% 50V M	X2
806	CQ0006	0.082μF +10% -10% 50V M	X3
807	CE0099	2.2μF +75% -10% 50V E	X1
808	CE0099	2.2μF +75% -10% 50V E	X2
809	CK0113	0.001μF +10% -10% 50V C	X1
810	CK0113	0.001μF +10% -10% 50V C	X1
811	CE0099	2.2μF +75% -10% 50V E	Y1
812	CE0074	10μF +50% -10% 16V E	Y1
813	CK0159	0.1μ +80% -20% 25V C	X1
814	CE0078	100μF +50% -10% 16V E	X1
R801	RB0254	1M R25	Y3
802	RB0254	1M R25	X3
803	RB0254	1M R25	Y3
804	RB0254	1M R25	X4
805	RB0202	6.8K R25	Y3
806	RB0202	6.8K R25	X2
807	RB0200	5.6K R25	Y2
808	RB0200	5.6K R25	Y2
809	RB0216	27K R25	X1
810	RB0216	27K R25	X2
811	RB0218	33K R25	Y1
812	RB0206	10K R25	Y1
813	RB0222	47K R25	Y1
814	RB0182	1K R25	Y1
815	RB0198	4.7K R25	Y1
816	RB0206	10K R25	Y1
817	RB0230	100K R25	Y1
818	RB0246	470K R25	X1
819			
Q801	TR0146	2SC1740	Y1
802	TR0146	2SC1740	X1
D801	TD0016	1S1555	Y1

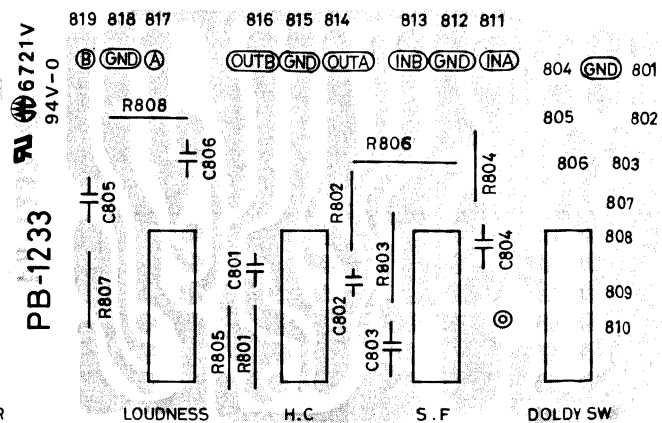
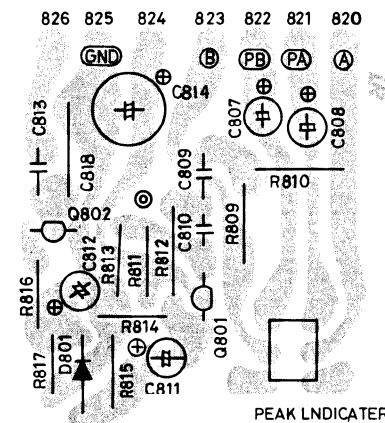
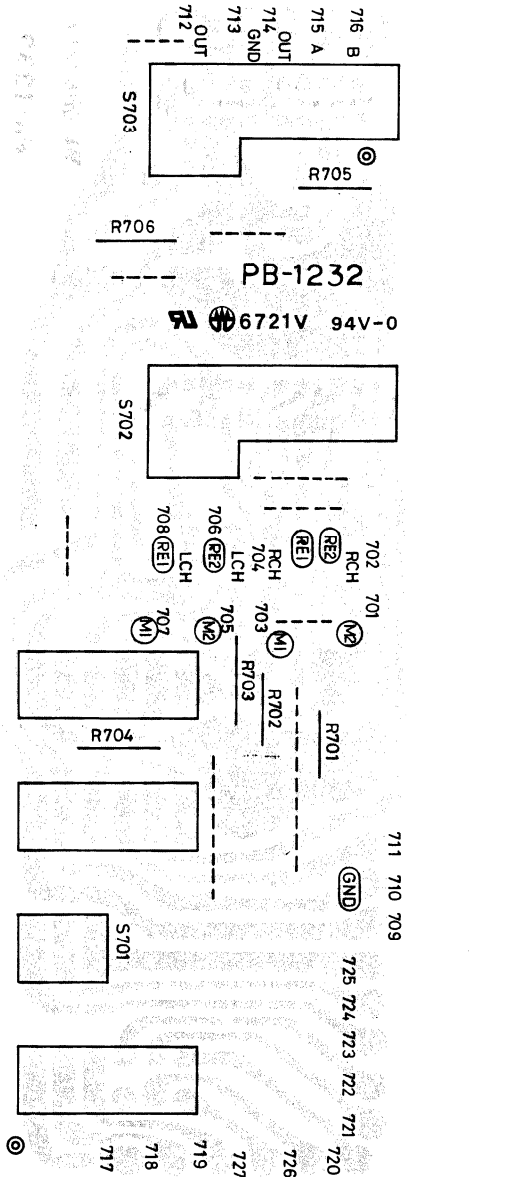

SYMBOL NO.	STOCK NO	DESCRIPTION	LOCA- TION
C401	CE5025	3.3 μ F +75% -10% 50VECX	Y1 X1
402	CC0005	33pF +10% -10% 50V C	Y2 X2
403	CE0078	100 μ F +50% -10% 16V E	Y1 X1
404			
405	CQ0130	0.001 μ F + 5% - 5% 50V M	Y4 X4
406	CQ0130	0.001 μ F + 5% - 5% 50V M	Y4 X4
407	CQ0122	0.0068 μ F + 5% - 5% 50V M	Y4 X4
408	CE2040	10 μ F +50% -10% 50VENX	Y2 X2
409	CC0037	5pF +0.5pF -0.5pF 50V C	Y3 X3
410	CE5019	1 μ F +75% -10% 50VECX	Y2 X2
411			
412	CE0068	47 μ F +50% -10% 10V E	Y3 X3
413	CE0102	47 μ F +50% -10% 50V E	Y3 X3
408	CC0008	150pF +10% -10% 50V C	Y3 X3
R401	RD0022	47K	Y1 X1
402	RD0009	470K	Y2 X2
403	RD0039	2.2K	Y2 X2
404	RD0004	1M	Y2 X2
405	RD0028	15K	Y1
406	RD0216	470	Y3 X3
407	RD0040	1.8K	Y3 X3
408	RD0023	39K	X2
409	RD0006	820K	Y4 X4
410	RD0045	820	Y2 X2
411	RD0022	47K	Y2 X2
412	RD0017	100K	Y3 X3
413	RD0023	39K	Y4 X4
414	RD0032	8.2K	Y3 X3
415	RD0042	1.2K	Y3 X3
416	RD0011	330K	Y2 X2
417	RD0039	2.2K	X4

R-1070 DC STEREO TUNER-AMPLIFIER SPECIFICATIONS

[AUDIO SECTION]

Power Output:	75 watts minimum continuous per channel both channels driven into 8 ohms load at any frequency from 20Hz to 20,000Hz with no more than 0.025% total harmonic distortion.	
Rated I.M.:	no more than 0.025% (8 ohms, 75W/ch, both ch driven, 60Hz: 7kHz = 4 : 1)	
Frequency Response:	15Hz – 100kHz (± 1 dB)	
Input Sensitivity:	2.7mV (phono-1/2), 160mV (tuner, aux, moni.), 1.4V (main in)	
Phono Overload Voltage:	160mV (at 1kHz)	
Signal to Noise Ratio:	86dB (phono-1/2, IHF-A weighted, 10mV) 100dB (tuner, aux, monitor, IHF-A weighted)	
Residual Noise:	no more than 0.3mV	
Channel Separation:	75dB (aux, monitor) (at 1kHz)	
Tone Control:	TREBLE ± 10 dB at 10kHz	BASS ± 10 dB at 100Hz
Filters:	Subsonic 30Hz (-6 dB/oct.)	High Cut 7kHz (-6 dB/oct.)
Loudness Control:	+8dB at 100Hz (VR: -30 dB)	
Peak Indicator:	+3, 0, -3, -6, -9, -12, -15, -18, -21, -24dB	

[FM SECTION]

50dB Quieting Sensitivity:	75 μ sec. 14.2 dBf (2.8 μ V), 50 μ sec. 15.3dBf (3.2 μ V)	
IHF Usable Sensitivity:	10.3dBf (1.8 μ V)	
Signal to Noise Ratio at 65dBf:	75dB	
Frequency Response:	30Hz – 15kHz (± 1 dB)	
Total Harmonic Distortion:	(mono)	(stereo)
100Hz	0.06% (wide)	0.15% (wide)
1kHz	0.06% (wide)	0.1% (wide)
6kHz	0.12% (wide)	0.2% (wide)
1kHz	0.2% (narrow)	0.5% (narrow)
Capture Ratio:	0.9dB (wide)	1.9dB (narrow)
Image Response Ratio:	85dB	
IF Response Ratio:	90dB	
AM Suppression Ratio:	62dB	
Stereo Separation:	45dB (wide, 100Hz), 48dB (wide, 1kHz) 40dB (wide, 10kHz), 30dB (narrow, 1kHz)	
Spurious Response Ratio:	100dB	
Adjacent Channel Selectivity:	12dB (narrow, ± 200 kHz)	
Alternate Channel Selectivity:	80dB (narrow, ± 400 kHz), 60dB (narrow, ± 300 kHz) 48dB (wide, ± 400 kHz)	
Subcarrier Product Ratio:	65dB	
SCA Rejection Ratio:	60dB	
Output Voltage:	1V	
Muting Threshold:	10 μ V	

[AM Section]

IHF Usable Sensitivity:	250 μ V/m
Image Ratio at 1MHz:	50dB
IF Rejection Ratio at 1MHz:	40dB
Signal to Noise Ratio:	50dB

[General]

Power Consumption:	320VA (8 ohms, at full power)	2.8VA (CSA rated)
Dimensions:	490(W) x 405(D) x 180(H) mm (19-5/16" x 15-15/16" x 7-3/32")	
Weight:	Net 14.9kgs (32.8 lbs.)	Gross 16.5kgs (36.3 lbs.)
Additional Features:	Speaker Selector Switch, Headphone Jack, Tape Dubbing Circuit, Tape Monitor Circuit, Peak Indicator Sensitivity Selector, FM IF Bandwidth Selector, FM Muting Off Switch, Mode Switch, AM Loop Stick Antenna, Protection Circuit, etc.	

Specifications and appearance design subject to change without notice.

* Dolby is the trademark of Dolby Laboratories.