

CONGRATULATIONS!

With your purchase of a FISHER instrument you have completed a chain of events that began many months ago, in our research laboratories. For it is there that the basic concept of the equipment you have just acquired came into being—its appearance, its functions, its quality of performance, its convenience of use.

But the end step—your purchase—is merely a beginning. A door has now opened, for you and your family, on virtually unlimited years of musical enjoyment. Recognizing that one of the keys to pleasurable ownership is reliability, we have designed this instrument to give long and trouble-free service. In fact, instruments we made over twenty-seven years ago are still in use today.

Remember always that we want this equipment to give you the best performance of which it is capable. Should you at any time need our assistance toward that objective, please write me personally.

AN IMPORTANT SUGGESTION

Many hours have been spent by our engineers and technical writers to create this instruction book for your guidance and enjoyment. If you want the **most** out of your FISHER, there is only one way to obtain it. With the equipment before you, please read this booklet carefully. It will be time well spent!

Avery Fisher

Founder and President

FISHER FIRSTS

Milestones In the History of High Fidelity Reproduction

- 7 First high-fidelity sound systems featuring a beam-power amplifier, inverse feedback, acoustic speaker compartments (infinite baffle and bass reflex) and magnetic cartridges.
- 7 First exclusively high-fidelity TRF tuner, featuring broad-tuning 20-20,000 cycle fidelity.
- 7 First two-unit high-fidelity system with separate speaker enclosure.
- 8 First coaxial speaker system.
- 8 First high-fidelity tuner with amplified AVC.
- 9 First dynamic range expander.
- 9 First 3-way speaker in a high-fidelity system.
- 9 First center-of-channel tuning indicator.
- 5 First preamplifier-equalizer with selective phono-graph equalization.
- 8 First dynamic range expander with feedback.
- 9 First FM-AM tuner with variable AFC.
- 2 First 50-watt all-triode amplifier.
- 2 First self-powered master audio control.
- 3 First self-powered, electronic sharp-cutoff filter system for high-fidelity use.
- 3 First universal horn-type speaker enclosure for any room location and any speaker.
- 3 First FM-AM receiver with a cascode front end.
- 4 First low-cost electronic mixer-fader.
- 4 First moderately priced professional FM tuner with two meters.
- 5 First peak power indicator in high fidelity.
- 5 First master audio control chassis with five-position mixing facilities.
- 5 First correctly equalized, direct tape-head preamplifier with self-powered master audio control.
- 1956 First all-transistor preamplifier-equalizer.
- 1956 First dual dynamic limiters in an FM tuner for home use.
- 1956 First performance monitor in a high-quality amplifier.
- 1956 First FM-AM tuner with two meters.
- 1956 First complete graphic response curve indicator for bass and treble.
- 1957 First GOLDEN CASCODE FM tuner.
- 1957 First MicroRay tuning indicator.
- 1958 First stereophonic radio-phonograph with magnetic stereo cartridge.
- 1959 First high-quality remote control system.
- 1959 First complete stereophonic FM-AM receiver (FM-AM tuner, audio control, 40-watt amplifier).
- 1959 First high-compliance plus high-efficiency Free-Piston loudspeaker system.
- 1960 First to use MicroRay for FM tuning and as a recording audio level indicator.
- 1960 Smithsonian Institution, Washington, D. C., receives for its collection America's first commercially manufactured high-fidelity radio-phonograph, made by Avery Fisher in 1937.
- 1960 First reverberation device for use in high fidelity equipment—the Fisher Dynamic Spaceexpander®.
- 1960 First stereo tuner with MicroTune.
- 1960 First front-panel antenna selector switch, 72-300 ohm, Local-Distant positions.
- 1961 First FM-Stereo multiplex adapter with STEREO BEACON and automatic switching, mono to stereo.
- 1961 First complete FM-multiplex stereo receivers.
- 1961 First FM-stereo tuners with STEREO BEACON and STEREO BEAM.
- 1961 First internal switching system to permit immediate tape playback with use of all controls and switches.
- 1962 First simplified-operation control-amplifier, with infrequently used controls behind front-panel cover, yet immediately accessible.
- 1962 First loudspeaker with eddy-current-damped voice coil.
- 1962 First FM tuner kit with separate d'Arsonval meter for tuning and separate cathode ray stereo broadcast indicator (STEREO BEAM).
- 1963 First power amplifier to use oscilloscope-type frequency-compensated input circuit.
- 1963 First amplifier kit with STRATABALANCE® visual dynamic balancing system.
- 1964 First multiplex adapter with 'flywheel synchronization.' Closely approaches theoretical limit of noise rejection, and of all spurious responses.
- 1964 First FM Stereo Tuner with STEREOSCAN®.
- 1964 First peripherally-driven tweeter with cotton, soft dome.
- 1964 First to use TUNE-O-MATIC® circuitry in an FM tuner.
- 1965 First All-in-One, All-Transistor 4-Gang Front-End.
- 1966 First F.E.T. front-end design with over 40 db of Automatic Gain Control (more than ten times that of the best prior solid-state techniques.)
- 1966 First FM tuner with Automatic FM Antenna Signal Attenuator.
- 1966 First FM tuner to achieve 0.6 db capture ratio—three times better than the best previous achievement.
- 1966 First FM Tuner to use a 10-megacycle-wide Counter Detector, eliminating all distortion for the life of the tuner.
- 1966 First FM Tuner with Clear Signal Indicator.
- 1966 First FM Tuner to incorporate a Power Amplifier Circuit for high-quality, low-impedance headphones.
- 1966 First time-division multiplex circuit to incorporate a Four-Diode Coincidence Circuit.
- 1966 First all-transistor FM Receiver to use Overload Protection.

OPERATING INSTRUCTIONS AND WARRANTY



THE FISHER[®]

500-T
STEREOPHONIC
FM Receiver

**WORLD LEADER IN
STEREOPHONIC HIGH FIDELITY**

TABLE OF CONTENTS



INTRODUCTION	1
INSTALLATION GUIDE FOR THE MAN IN A HURRY	2
OPERATING GUIDE FOR THE MAN IN A HURRY	4
ANTENNAS	6
SPEAKERS	7
ADDITIONAL COMPONENTS	8
CUSTOM INSTALLATION	12
MAINTENANCE	16
TECHNICAL SPECIFICATIONS	19

The Model 500-T FM-stereo receiver represents a major departure in the design of compact, high-powered all-transistor receivers. Its FM-tuner section uses no tubes or nuvistors; instead it employs revolutionary new silicon field-effect transistors (FET's) to eliminate the overload and distortion problems previously associated with some vacuum-tube and early solid-state front ends. At the same time, these remarkable devices provide a high degree of sensitivity and selectivity.

The 500-T combines—on one compact chassis—a highly sensitive FM-tuner section with SUPER SYNCHRODE* and exclusive STEREO BEACON**, a versatile low-noise preamplifier-control section, and a wideband, low-distortion silicon-transistor power amplifier employing the Fisher *Transist-O-Gard** circuit that protects it against overload or short-circuit damage.

This combination results in an FM receiver capable of “pulling in” even the weakest FM stations as well as handling the most powerful local stations without overloading or distortion. Excellent stereo separation is maintained under all receiving conditions and enough clean reserve audio power is available for even the most inefficient speaker systems. The result—that effortless ‘transparent’ sound that has become the hallmark of all FISHER transistorized components.

Reliability—this is another traditional FISHER hallmark. The superb performance of this receiver will last for years to come because of its inherently conservative design—all parts are rated for operating conditions in excess of any likely to be encountered in normal use. As an extra precaution, the receiver's output transistors and power supply are fuse-protected against damage caused by faulty speaker connections.

A final word—the 500-T, like any precision electronic instrument, will deliver its full capabilities only when it is allowed to do so by the user. For this reason, we urge you to read this manual carefully before attempting to install and operate the receiver. If you simply can't wait or if you have had previous experience with other high fidelity components and feel that you don't need elaborate instructions, please read the *INSTALLATION and OPERATING guides FOR THE MAN IN A HURRY*—they're vitally important.

**The trademark, STEREO BEACON* signifies this model has the exclusive convenience feature that automatically switches to the stereo mode, signals the presence of the stereo broadcast, and automatically switches back to mono again—according to the type of program being received.

*Patent Pending

INSTALLATION GUIDE FOR THE MAN IN A HURRY

We realize that you are anxious to play your new FISHER receiver and, frankly, we're quite flattered. At the same time we must warn you that a few precautionary measures are in order; those few extra minutes spent now in installing the receiver correctly will avoid needless disappointment later on and will assure years of enjoyable, trouble-free listening. To simplify your job, we have prepared this special pictorial procedure (keyed to Figure 1) — it will enable you to install the receiver in the least possible time with a minimum number of external connections. After completing the installation as outlined in this section, you may proceed directly to the next section, *OPERATING GUIDE FOR THE MAN IN A HURRY*. We do recommend, however, that you read the rest of this manual at your earliest convenience to ensure that you derive maximum possible enjoyment from your receiver.

1 POWER REQUIREMENTS

Before you do anything else, look at the markings on the receiver's nameplate and on its rear panel (to the left of the power cord). They indicate the AC voltage range for which your unit was wired. Make certain that the electrical power in your home is 50-60 Hz (cps) AC (*not* DC) and that its voltage lies within the range marked on the receiver. In the rare event that it does not, HAVE A QUALIFIED SERVICE TECHNICIAN MAKE THE NECESSARY WIRING AND FUSE CHANGE (as described in the Service Manual packed with the set). If you are not sure about the type of power in your home or about the operating range of your receiver, consult your local utilities company or dealer. **Do not connect the power cord to an electrical outlet or turn on the receiver yet.**

2 LOCATION

Place the receiver on any conveniently located shelf or table that is away from radiators, warm-air ducts or other sources of heat; the shelf should be deep enough to permit at least 2 inches clearance behind the receiver chassis for ventilation. Never place the unit on a soft or yielding surface; this could impede ventilation through the underside of the chassis.

For enhanced appearance, the receiver may be installed in the FISHER Model 100-U component cabinet; this attractive walnut enclosure is available at your dealer. While the chassis may be inserted in the cabinet at any time, this procedure is simplest when performed before any connections have been made to the receiver. For information on installing the receiver in your own custom cabinet or console, refer to the *CUSTOM INSTALLATION* section of this manual. Do not attempt such installations without first reading that section.

3 ANTENNA

Remove the FM dipole antenna from the accessories envelope and unfold it. Connect the spade lugs on its lead-in (the long leg of the "T") to the two lower terminals (marked NORM) on the receiver's rear-panel FM ANT terminal strip. Stretch the arms of the antenna *horizontally* and fasten them to a wall, to the rear surface of a cabinet or shelf, or to any convenient *non-metallic* surface. We suggest that you use masking tape temporarily until you decide on a final location for the antenna. If you use metallic staples or tacks, make sure that they don't cut or short-circuit the conductors running along both edges of the antenna wire. For more detailed information on antenna installation, refer to the *ANTENNAS* section of this manual.

4 SPEAKERS

If you are using two speakers for conventional stereo

or mono reproduction, place them along a wall or on shelves so that they face your proposed listening position. Initially, place them from 5 to 10 feet apart. (This is just a preliminary location; you may want to move the speakers closer together or further apart later on.)

If the speakers are no more than 50 feet each from the receiver, you may use ordinary two-conductor lamp cord or antenna twin-lead for connections; otherwise heavy-duty cable will be necessary. Cut the cables to the desired length, but leave some slack in case you want to change the locations of the speakers. Strip about half an inch of insulation from the ends of the cables.

To prevent any confusion when you connect the speakers, use the following definitions: The left main speaker is the one to your left as *viewed from your listening position*; conversely, the right speaker is the one to your right. (Figure 1 is a rear view of the speakers as well as of the receiver; for this reason their positions seem reversed.)

One of the terminals on your left main speaker may be marked COM, GND, C, or G or color-coded with a black dot. Connect this terminal to the COM terminal (next to MAIN) on the receiver's LEFT SPKRS terminal strip as shown in Figure 1. The other terminal on the speaker may be marked with the speaker's rated impedance (4, 8, or 16) or with a red dot; connect this terminal to the MAIN terminal on the LEFT SPKRS terminal strip. Connect the right main speaker to the receiver's RIGHT SPKRS terminal strip in the same manner; in other words, connect the speaker's COM or GND terminal to the appropriate COM terminal and the other speaker terminal to the MAIN terminal. Compare both speaker connections with the illustration; it is essential that they be connected this way for proper phasing.

Check all connections, both at the speakers and at the receiver. Make sure that there are no stray strands of wire shorting one terminal to an adjacent terminal or to the receiver chassis. For further details on connecting speakers to this receiver, refer to the *SPEAKERS* section of this manual.

CAUTION: To avoid annoying hum and noise, never connect the COM terminals on the LEFT SPKRS terminal strips to the COM terminals on the RIGHT SPKRS terminal strip; always use a separate conductor from each COM terminal to the COM or GND terminal of its corresponding speaker.

5 RECORD PLAYER

To connect a record player using a *magnetic* cartridge, use Figure 1 as a guide. If the record player has a ground wire, loosen the hex-head screw near the bottom

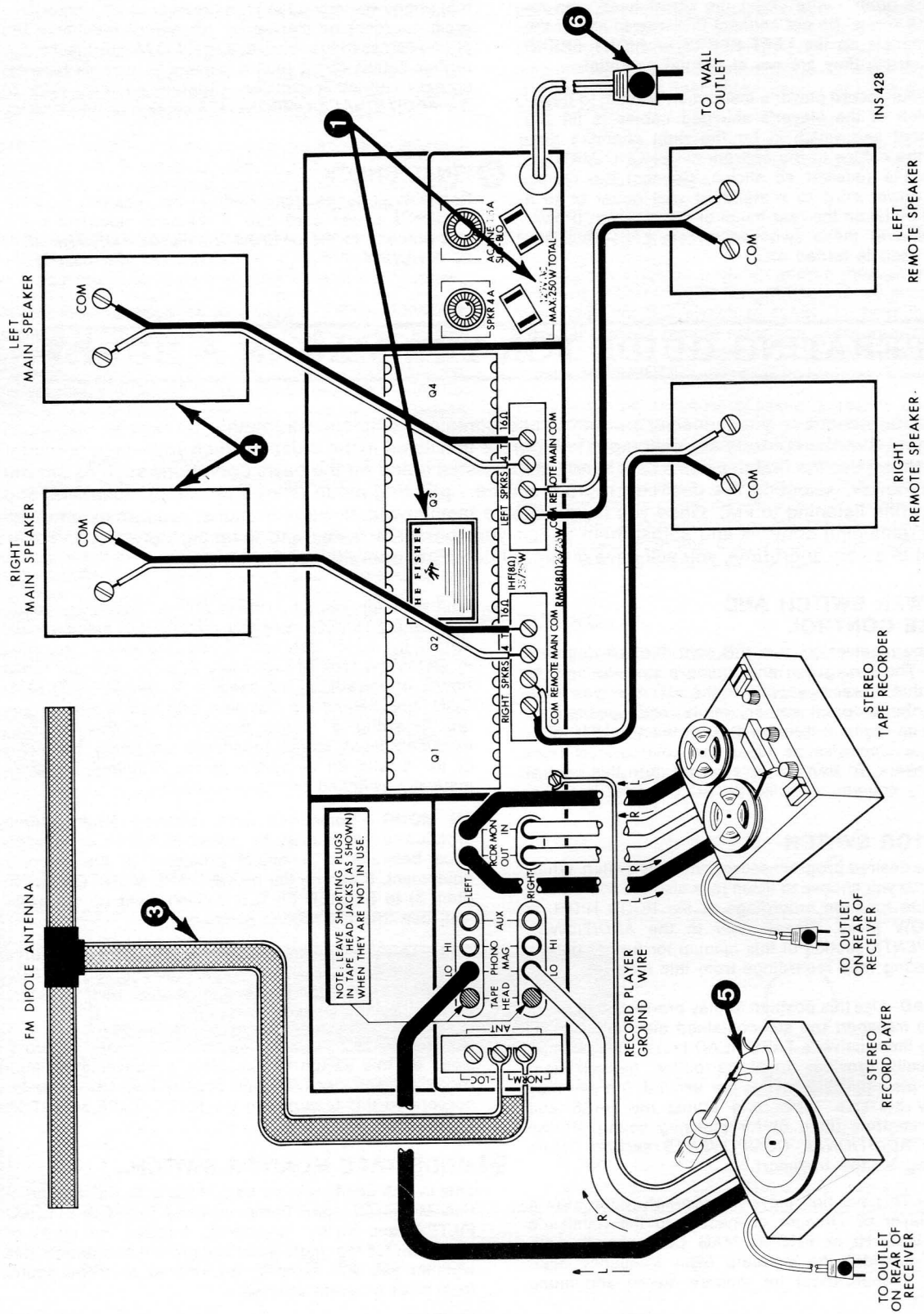

Figure 1. Rear Panel of the 500-T

center of the rear panel, slip the spade lug on the free end of the ground wire under the screw head, and retighten the screw. **Do not connect this wire to any of the COM terminals on the LEFT SPKRS or RIGHT SPKRS terminal strips; they are not at ground potential.**

Consult your record player's Instruction Manual to determine which of the player's shielded cables is for the left channel and which is for the right channel; then connect the cables to the appropriate PHONO MAG LO jacks on the receiver as shown. Connect the record player's power cord to a standard wall outlet or to a switched outlet on the rear panel of the receiver. (Power is available at these switched outlets only when the receiver itself is turned on.)

If, after playing records through the receiver, you find that phono volume is too high (compared with other program sources) or marred by distortion, reconnect the phono cables to the receiver's PHONO MAG HI jacks. For further details about record players as well as tape recorders and other auxiliary program sources, refer to the *ADDITIONAL COMPONENTS* section of this manual.

6 FINAL CHECK

Recheck all connections made to the receiver. Plug the receiver's power cord into a standard electrical outlet and proceed to the *OPERATING GUIDE FOR THE MAN IN A HURRY*.

OPERATING GUIDE FOR THE MAN IN A HURRY

This section describes your receiver's controls and contains complete information on how to use them. Please note that the controls are called out in Figure 2 and listed in the order in which you would normally operate them; use the first five items as a handy step-by-step guide for the basic operations such as turning on the receiver, selecting the desired program source, operating mode (stereo or mono), speakers, and station (when listening to FM). Once you have become familiar with these operations, you can experiment with the remaining controls and adjust them to suit your personal tastes and listening conditions. You'll find, that in a very short time, you will have mastered complete operation of the receiver.

1 AC POWER SWITCH AND VOLUME CONTROL

To turn the receiver on, turn this control clockwise until it clicks. The tuning dial and tuning meter will light to indicate that power is applied to the set. After you have selected the program source, mode, and speakers of your choice (items 2 through 4), turn the VOLUME control further clockwise to adjust the volume level from your speakers. To turn the receiver off, turn this control completely counterclockwise (to AC off) until it clicks.

2 SELECTOR SWITCH

Select the desired program source with this switch. Whatever source you choose to listen to is also the source that is available for tape recordings at the RCDR HIGH or RCDR LOW jacks. Please refer to the *ADDITIONAL COMPONENTS* section of this manual for further details about making tape recordings from this receiver.

TAPE HEAD—Use this position to play pre-recorded tapes on a tape *transport* (no self-contained electronics) connected to the receiver's TAPE HEAD jacks. This position automatically provides tonal correction (equalization) for tapes played at 7½ inches per second, but you may also play 3¾-i.p.s. tapes and adjust the BASS and TREBLE controls (item 6) for pleasing sound. Please read the *ADDITIONAL COMPONENTS* section before connecting a tape transport.

PHONO—This position plays phonograph records on a record player or changer connected to the receiver's PHONO MAG HI or PHONO MAG LO jacks. It automatically provides the standard RIAA frequency compensation (equalization) for modern stereo and mono recordings.

FM AUTO—In almost all cases, use this position to receive FM broadcasts (stereo or mono) through the

built-in tuner section. Under normal receiving conditions, the STEREO BEACON circuits will *automatically* switch the tuner between stereo and mono operation to match the type of broadcast to which you are tuned (mono or stereo); at the same time, the STEREO BEACON lamp behind the dial glass will light whenever you are receiving a stereo broadcast. In this position, *extremely weak* stereo broadcasts (normally too noisy or too erratic for enjoyable stereo listening) are automatically switched to mono reception.

FM MONO—Sometimes even relatively strong stereo broadcasts are marred by noise, distortion or interference because of technical problems in the station's equipment. If setting the MODE/TAPE MONITOR switch (item 3) to STEREO FILTER doesn't clear up the problem, use this FM MONO position.

AUX—This position selects any auxiliary program source connected to the AUX jacks. Please refer to the *ADDITIONAL COMPONENTS* section of this manual before connecting any such sources.

NOTE: You may have noticed that there are no provisions on this switch for selecting a conventional tape recorder, tape deck or tape player. Instead, we've incorporated this feature into the MODE/TAPE MONITOR switch (item 3).

3 MODE/TAPE MONITOR SWITCH

This switch combines *two* basic functions. Its main function, MODE (comprising the left-hand STEREO, STEREO FILTER, and MONO positions), controls the mode of operation for the *audio amplifier* section and determines whether you will actually *hear* stereo or mono sound from most program sources.

STEREO—As a general rule of thumb, *always keep the switch in this STEREO position whenever you are listening to FM broadcasts*; this will assure that you

always hear stereophonic sound when tuned to a station broadcasting in stereo. (Please remember that the tuner circuits will *automatically* switch between stereo and mono reception for you when the SELECTOR switch is set to FM AUTO.) For all *other* program sources chosen with the SELECTOR switch (TAPE HEAD, PHONO, AUX), use this position only if the source is stereophonic.

STEREO FILTER—Use this position for all stereo sources (including FM broadcasts) chosen with the SELECTOR switch that are somewhat noisy, but not so noisy that they would have to be listened to monophonically.

MONO—Use this position if any program source (except FM) chosen with the SELECTOR switch is monophonic or if you are using only one speaker with the receiver.

The second function of this switch, TAPE MONITOR (comprising the right-hand STEREO TAPE, TAPE L, and TAPE R positions), provides convenient means for playing a tape recorder, tape deck, or tape player through the receiver's MON IN jacks. Please refer to the *ADDITIONAL COMPONENTS* section of this manual before connecting any such tape devices.

STEREO TAPE — Use this position to play stereo tapes on a stereo tape machine connected to the receiver.

NOTE: While this position can be used for conventional playback from almost all stereo tape recorders, decks, and players it can also be used for *monitoring* purposes with recorders or decks having true tape-monitoring facilities (separate record and playback circuits and heads). With such tape units, you can instantly compare the sound quality of the original program material with the taped version of the same material *while recording*. To do this, simply alternate the setting of the switch between the STEREO (to hear the original program material as usual) and the STEREO TAPE (to hear the same material, a fraction of a second later, as it sounds on tape). For further details, refer to the *ADDITIONAL COMPONENTS* section.

TAPE L — Use this position when playing from a monophonic tape recorder, deck, or player connected to the left-channel MON IN jack; this will permit you to hear the monophonic tape through both speakers. If your machine is a four-track stereo/mono device, this position will permit you to hear either track 1 or track 4 through both speakers.

TAPE R — This position will permit you to hear either track 2 or track 3 of the same four-track tape device through both speakers.

4 SPEAKERS SWITCH

To hear the selected program source through the main speakers (connected to the MAIN and adjacent COM terminals), set this switch to MAIN. To hear the same material through remote extension speakers (connected to the REMOTE and adjacent COM terminals), set the switch to REMOTE.

If there are no extension speakers presently connected to the receiver, you may use the REMOTE position as a convenient means of shutting off the main speakers when listening through headphones or when you simply want to silence the system momentarily without shutting off the receiver or changing its VOLUME control setting. For further information on using remote speakers and headphones with this unit, refer to the *ADDITIONAL COMPONENTS* sections of this manual.

5 TUNING

Turn the TUNING control *slowly* until the lighted dial pointer indicates the station of your choice. The large scale on the dial glass is calibrated in the actual broadcasting frequencies of the stations in the 88- to 108-MHz (Mc) FM-broadcast band while the small (logging) scale shows numbers ranging from 1 through 100. Use whichever scale is more convenient for you, but always tune

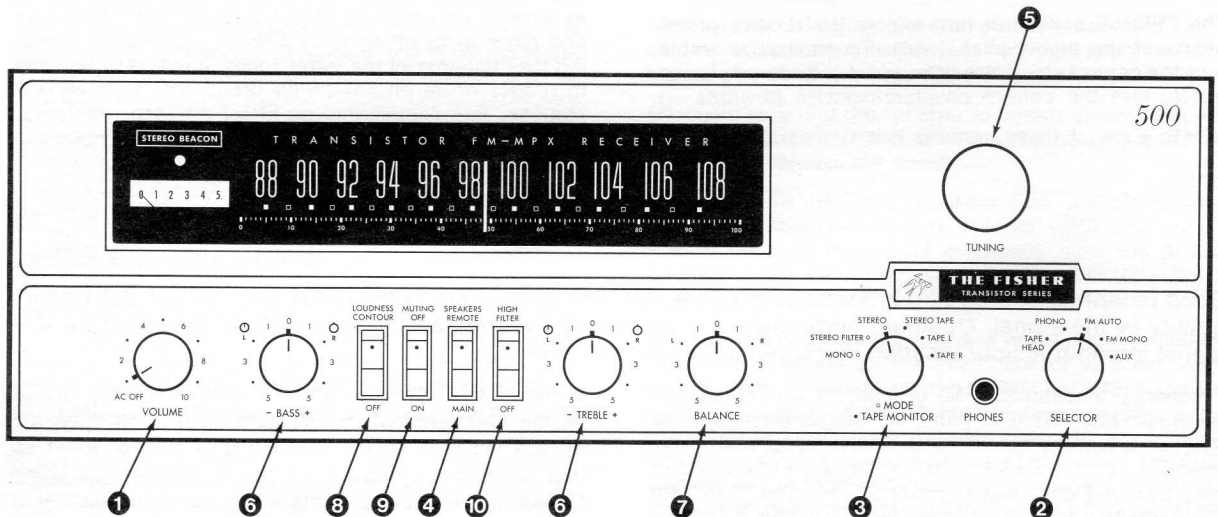

Figure 2. Front Panel of the 500-T

for the maximum tuning-meter indication obtainable for the station of your choice. This coincides with the point called "center of channel" for that station; it is the only point at which you will obtain clear, undistorted reception (and, in the case of FM-stereo broadcasts, maximum audible stereo separation).

If the SELECTOR switch has been set to FM AUTO, the STEREO BEACON lamp (directly above the meter) will light whenever you come to a station broadcasting in stereo; at the same time, the tuner will also switch into stereo reception. **Remember, however, that you'll hear stereo sound only if the MODE/TAPE MONITOR switch is set to STEREO or STEREO FILTER.**

The lamp should remain lighted so long as the station you're listening to keeps broadcasting in stereo. If the lamp starts to blink on and off, or if the program sounds noisy, distorted, or erratic in quality (even with the MODE/TAPE MONITOR switch set to STEREO FILTER), set the SELECTOR switch to FM MONO. The blinking will stop and you can listen to the broadcast monophonically.

6 BASS AND TREBLE CONTROLS

These controls affect the tonal quality of the music and speech to which you are listening. *In most cases, keep them set at or near their normal mid-positions (marked O);* under normal conditions—especially with modern recordings and broadcasts—these settings should reproduce sound very close to that of the original live performance. Sometimes, tonal quality may be altered by a number of factors at the recording or broadcasting studio (unusual microphone placement, non-standard bass and treble equalization, restricted-fidelity equipment, etc.) or in the home by the acoustical properties of different speakers, headphones and listening rooms. In such cases, adjust these controls for the sound that seems natural and pleasing to you.

The BASS control affects the relative prominence of the lower-pitch tones. To emphasize bass, turn the control clockwise (towards +); to de-emphasize bass, turn the control counterclockwise (towards -).

The TREBLE control in turn affects the relative prominence of the higher-pitch tones. To emphasize treble, turn the control clockwise (towards +); to de-emphasize treble, turn the control counterclockwise (towards -).

NOTE: Each of these controls has two parts; the inner

knob for the left channel and the outer knob for the right channel. Normally both parts of each control turn together as one unit, but if you want to adjust the tonal quality for each channel separately (as you might, for instance, if you are using a different type of speaker in each channel), hold one part of the knob while turning the other.

7 BALANCE CONTROL

Adjust this control so that the volume levels from both speakers in your listening area sound about equal from your *listening position*. Ideally, this should occur with the control set to its mid-position (marked O). However, differences in room layout, imbalances in the program source, or your listening position may make it necessary to turn the control either clockwise (to increase the sound level on the right and decrease the sound level on the left) or counterclockwise (to increase the left and decrease the right). At the extreme settings of this control, only one speaker or the other will be heard. *Do not use the BALANCE control as a substitute for the VOLUME control.*

8 LOUDNESS CONTOUR

This switch is meant primarily for use at low volume levels, where the human ear does not respond to the extremely low bass or high treble tones as well as it does at normal or high levels. This will result in somewhat thin and undetailed sound quality, but pushing in the top portion of this switch automatically emphasizes bass and treble by a predetermined amount, thus restoring apparent tonal balance. At higher settings of the VOLUME control, the effect of this switch tapers off.

9 MUTING

Keep this switch ON to eliminate the hiss and static that would normally be heard between FM stations when tuning. Extremely weak stations are also muted; these broadcasts are difficult to tune in, almost impossible to listen to in stereo and do not provide the static-free reception that is possible only with stronger signals.

10 HIGH FILTER

This filter reduces annoying high-frequency noise (such as scratch and hiss) in records, tapes, FM broadcasts and other program sources without appreciably reducing the crispness of the treble tones. It may also be used to reduce noise on FM-stereo broadcasts from weaker stations; this control has no effect on tape recordings made from the receiver.

ANTENNAS

Good reception of FM-radio broadcasts depends not only on the sensitivity of your receiver but also on the quality of the signal. Optimum performance is assured only when an antenna system, adequate for the signal strength in your location, is connected to your receiver.

Frequency Modulation (FM) broadcasts are transmitted on the 87-108 MHz (Mc) band, sometimes referred to as VHF, in a manner similar to television broadcast transmissions. Such transmissions are usually considered to be "Line-of-Sight" signal propagations and it is rare that reception is reliable when the transmitter is beyond the horizon. A laboratory-designed dipole FM antenna is packed with the tuner. The two "arms" of the T-shaped antenna should be mounted horizontally, away from electrical power wiring and large metallic objects. The connecting lugs of the lead-in (the long leg of the T) should

be attached to the two terminal screws marked NORM on the ANT terminal strip (Figure 1). It is often helpful to tack the arms of the antenna to a strip of wood so that the antenna may be rotated in a horizontal plane to pick up the strongest signal and to avoid distortion caused by signal reflections. (When tacking down the antenna or the lead-in, be careful that the tacks do not go through either of the conductors in the antenna wire and also that the tack head does not cause a "short" from one conductor to the other.)

Because the signal is normally stronger near an outside window, the lead-in of the antenna may be extended with standard 300-ohm "twin-lead" antenna wire so that the antenna may be placed in the best position. The special FISHER laboratory dipole antenna, supplied with the set, will prove to be fully effective except possibly in weak-signal "fringe" areas or where severe reflection (multi-path) problems exist.

In strong-signal areas, where distortion is caused by signal reflection from other buildings, towers or hills, it is advisable to use an adjustable, directional indoor antenna. (Such signal-reflection distortion is termed multi-path distortion and is similar to the "ghosts" which sometimes mar television reception.) Special antennas are usually available commercially in areas where such reception problems occur and are of the "rabbit-ears" or telescoping dipole type.

In weak-signal areas, an outdoor antenna is almost a necessity, especially for the reception of FM-stereo broadcasts. Though an omni-directional antenna may sometimes be satisfactory, directional antenna arrays are usually advisable. In localities where FM broadcast signals come from several different directions, a remotely-controlled antenna rotator is a useful accessory. If you already have an outdoor VHF television antenna, it may also be suitable for FM reception. Connect it

temporarily to your receiver—if the results are satisfactory, obtain an antenna coupling transformer so that both your receiver and the television can be operated from the same antenna.

When an outdoor FM antenna is used, it is usually connected to the receiver by standard 300-ohm "twin-lead" antenna wire. Sometimes, if you are located near a busy highway or in an industrial area, it may be necessary to use shielded lead-in to prevent disturbing interference caused by ignition systems or electrical machinery. Coaxial cable, of 75-ohm impedance, may be used; however this would necessitate the use of impedance matching transformers both at the antenna and at the input to the receiver. Shielded 300-ohm twin-lead antenna wire is available from major electronic parts dealers and should be used whenever electrical interference noise becomes a problem. The two signal conductors are connected to the NORM terminals in the usual manner and the shield is attached to the hex-head screw normally used for grounding the record player.

If you are located very close to an FM transmitting station, the signal might be so strong that this station could be received at more spots on the dial than just its assigned frequency. In such rare cases, the antenna lead-in should be connected to the ANT terminals marked LOC.

SPEAKERS

PLACEMENT

Speaker systems are usually positioned along a wall, with the provision that no large pieces of furniture block the sound path between the speakers and the listening area. Placing the speakers on the floor and in a corner will emphasize the bass (low frequency) tones.

In a stereo system, the speakers should be placed opposite the listening area. If the listening area is about 10 feet away from the speakers, the stereo-speaker systems should be at least 5 to 10 feet apart. Increasing the distance between the speakers will increase the stereo effect—bringing them closer together will make the stereo effect less noticeable. Experiment with several speaker arrangements before making the positions permanent.

Occasionally some furniture arrangements, irregular room dimensions or echoes from adjacent hallways or rooms will affect the sound quality. These are individual problems—there is no cure-all—just experiment.

CABLE REQUIREMENTS

For distances of 50 feet or less you may use ordinary lamp cord or antenna twin lead. Heavier gauge wire should be used for greater distances to prevent power losses in the wiring. *Do not* remove more than a half-inch of insulation from the ends of the speaker cables. Any greater length of exposed wire is likely to cause short circuits at either the speaker terminals on the rear of the chassis or those on the backs of the speakers themselves, and may cause a fuse to blow. Twist all exposed strands of wire tightly, so that the ends of the wire become easy to handle.

To simplify connections (and speaker phasing) use a cable that will help you to identify the individual wires. Some types of cable have a ridge, or groove, molded

on one side of the insulation, another type has a colored thread under the insulation of one lead.

Do not drive nails through the speaker-cable insulation if you attach it to the wall, unless the wires are well separated. Shorts made this way can cause intermittent or permanent defects—that remain even after the nail is removed from the point where it went through the insulation.

PRECAUTIONS

Observe the following general precautions when connecting loudspeakers to this receiver; they apply regardless of the number of speakers involved:

(1) Make sure that the receiver is turned off and that its power cord is disconnected from the electrical outlet *before* you connect the speakers.

(2) Make sure that your speakers have a rated impedance of *not less than 4-ohms*. A lower value may cause severe overload that could eventually blow the SPKR 4A fuse. If this should happen, refer to *OUTPUT FUSES* in the *MAINTENANCE* section of this manual.

(3) **To prevent annoying hum and noise, never connect the COM terminals on the LEFT SPKRS terminal strip to the COM terminals on the RIGHT SPKRS terminal strip; also, never connect any of these terminals to ground or use them as connection points for the ground wires of record players, tape transports, etc. Whether you use one or more speakers, use a separate wire from each COM terminal to the "Com" or "Gnd" terminal of its corresponding speaker.**

(4) *Before* turning on the receiver, check your connections both at the speakers and at the receiver. Remove stray strands of wire shorting one terminal to an adjacent

CONNECTING ONE SPEAKER

If you are temporarily using only one speaker, make the connections on the receiver's rear-panel LEFT SPKRS terminal strip; connect one wire from the speaker to the MAIN terminal and the other to the COM terminal just to the left of it. Next, make sure that the SPEAKERS switch on the front panel of the receiver is set to MAIN; then set the MODE/TAPE MONITOR switch to MONO and turn the BALANCE control fully *counterclockwise*. This will permit you to hear full, blended monophonic reproduction of all program sources (both stereo and mono) through the left-channel amplifier and this speaker. (The right-channel amplifier is not used in this arrangement.)

CONNECTING TWO MAIN SPEAKERS

When two speakers are used in the same room or listening area, they must be connected to the receiver in such a way that their cones move back and forth *in unison*. This is known as phasing the speakers; it is essential for proper mono and stereo reproduction. In addition, each speaker should be connected to the correct terminal strip on the receiver so that you hear correct left-right placement of voices and instruments on a stereo broadcast or recording. To accomplish both of these things, use Figure 1 as a guide and perform the following procedure:

(1) One of the terminals on your left main speaker (please remember, left as viewed from your listening area) may be marked COM, GND, C, or G or color-coded with a black dot. Connect this terminal to the COM terminal (next to MAIN) on the receiver's LEFT SPKRS terminal strip. The other terminal on the speaker may be marked with the speaker's rated impedance (4, 8, or 16) or with a red dot; connect this terminal to the MAIN terminal on the LEFT SPKRS terminal strip.

(2) Connect the right main speaker to the RIGHT SPKRS terminal strip in the same manner; in other words, connect the speaker's COM or GND terminal to the receiver's COM terminal and the other speaker terminal to the receiver's MAIN terminal. Compare both speaker connections with the illustration.

(3) To check for correct speaker phasing, turn the receiver on, set the SPEAKERS switch to MAIN, set the SELECTOR switch to FM AUTO and turn the BALANCE control to its mid position (marked O). Then turn the TUNING control until you receive a *stereo* symphonic or orchestral program. (The STEREO BEACON lamp will light to indicate that you are receiving a stereo broadcast.) Set the MODE/TAPE MONITOR switch to MONO

program sources. If you are deficient in bass, turn on the receiver and carefully reverse the connections at one of the speakers. Turn the receiver on again and listen to the difference in bass response.

(4) Once the speakers have been properly phased, you can check for correct left-right stereo placement by setting the MODE/TAPE MONITOR switch to the STEREO position. If the speakers are correctly placed and connected, the violins will usually be heard from the left speaker. If you are in doubt, try more than one stereo station. If stereo placement sounds consistently reversed, switch speaker positions.

CONNECTING REMOTE EXTENSION SPEAKERS

The REMOTE terminals and their adjacent COM terminals provide means for connecting one or more pairs of extension speakers. This arrangement will enable you to enjoy stereophonic sound in other rooms of your home whenever you set the front-panel SPEAKERS switch to REMOTE.

If you are using only one pair of extension speakers, you may connect them to the receiver as shown in Figure 1. Connect the left speaker to the REMOTE and COM terminals on the LEFT SPKRS terminal strip and the right speaker to the corresponding REMOTE and COM terminals on the RIGHT SPKRS terminal strip. As with the main speakers, make sure that the extension speakers are in phase with each other by connecting the COM or GND terminal of each speaker to its corresponding COM terminal on the receiver as shown in the illustration. To check for correct speaker phasing and left-right stereo placement, use the procedures described in the paragraphs entitled *CONNECTING TWO MAIN SPEAKERS*, but set the SPEAKERS switch to REMOTE instead of to MAIN.

CAUTION: If you intend to use *more than one pair of extension speakers, the combined parallel impedance of all the extension speakers in each channel must still be 4-ohms or more. While there are mathematical formulas that can be used to determine the total impedance of various speakers connected in parallel, such data are beyond the scope of this manual. Therefore, before you attempt to connect a multi-speaker array to your receiver, we urge you to write to us for detailed information; please include the rated impedances of the speakers you are presently using with your receiver as well as information on how many extension speakers you are considering. Address all correspondence to: Mr. Richard Hamilton, Customer Relations Department, Fisher Radio Corporation, 11-40 45 Road, Long Island City, New York 11101.*

ADDITIONAL COMPONENTS

RECORD PLAYERS AND CHANGERS

Record players and changers using *magnetic* phonograph cartridges may be played through your FISHER receiver. This type may sometimes be called a moving-coil, moving-magnet, or variable-reluctance cartridge. Because designs do vary among various models—even among those from the same manufacturer—the electrical outputs of many of these cartridges will also vary. For this reason, we have included *two* sets of phonograph

inputs on the rear panel of the receiver; PHONO MAG HI (for relatively high-output cartridges) and PHONO MAG LO (for low-output cartridges). The following connection procedure includes information on how to determine which set of inputs is better suited for the cartridge in your record player:

NOTE: Do not use the PHONO MAG HI and PHONO MAG LO inputs at the same time; distortion will result if you do.

(1) Check to see if your record player has a ground wire (often green in color, with a spade lug at the free end). If it does, loosen the hex-head screw near the bottom center of the rear panel, (Figure 1); then slip the spade lug of the wire under the screw head and retighten the screw. *This is important if you wish to enjoy hum-free sound from your records.*

CAUTION: Do not connect this ground wire to any of the COM terminals on the LEFT SPKRS or RIGHT SPKRS terminal strips; these terminals are not grounded.

(2) Connect the shielded cables of the record player to the receiver's left channel and right channel PHONO MAG LO input jacks as shown in Figure 1. Usually, the instruction book that accompanies the record player will tell which cables to connect to the left-channel and right-channel jacks, respectively. If, for some reason, you cannot determine which is the left-channel or right-channel cable, temporarily connect them at random; you will be able to check for correct left-right stereo placement in step 4.

(3) Connect the record player's power cord to a standard wall outlet or to a free outlet on the rear panel of the receiver. In either case, keep the power cord as far as possible from the shielded cables that go to the receiver.

(4) Turn the receiver on, set the MODE/TAPE MONITOR switch to STEREO and the SELECTOR switch to PHONO; play a *stereo* symphonic or orchestral recording on the turntable and adjust the receiver's VOLUME control for a comfortable listening level. Listen to the placement of the violins; if they seem to be coming from or near the left speaker (again, left as viewed from your listening position), the phono cables are connected properly. If they seem to be coming from the right, switch the phono cables at the rear of the receiver.

NOTE: In the rare event that you hear only weak or distorted sound from the record, this is an indication that the phono leads at the rear of the cartridge, may have been inadvertently connected to the wrong terminals, causing the left- and right-channel signals to be out of phase with each other. It is a simple matter to correct this. Remove the cartridge shell from the tone arm; then use a pair of tweezers or long-nose pliers to switch the connections at the cartridge terminals for *one* stereo channel only. (Almost all stereo cartridges identify the two left-channel terminals with at least the letter L while the right-channel terminals are marked with the letter R.) Plug the cartridge shell back into the tone arm.

(4) Set the SELECTOR switch to FM AUTO and tune in an FM broadcast having music similar to that on the record. Turn the SELECTOR switch back and forth between FM AUTO and PHONO and listen to the relative volume levels of the two program sources—they should be approximately equal *without you having to readjust the VOLUME control each time you switch*. If phonograph volume is much higher than that of FM or if there is noticeable distortion on PHONO, switch the phono cables at the rear of the receiver to the PHONO MAG HI jacks. (Make sure that right-channel and left-channel cables go to the correct jacks.) Once again, turn the SELECTOR switch back and forth between FM AUTO and PHONO; the relative volume levels should now be almost equal.

(5) During normal operation with the record player, remember to set the receiver's MODE/TAPE MONITOR switch to STEREO when playing a stereo record and to MONO when playing a mono record. All other controls

may be adjusted in the usual manner to suit your personal tastes and listening conditions.

TAPE RECORDERS, DECKS, PLAYERS AND TRANSPORTS

Your FISHER receiver may be used as the heart of a complete system for making and playing back stereophonic and monophonic tape recordings. Once you have made the proper connections between your tape machine and the receiver, it is a simple matter to record whatever selected program source you are playing through the receiver (FM broadcasts, phonograph records, auxiliary sources, etc.). You may then play these—or any other—tape recordings through the receiver at your own convenience while retaining full use of the receiver's controls. As an added feature for tape machines having tape-monitor facilities (separate record and playback circuits and heads), this receiver will permit you to monitor the quality of the recording and compare it with the quality of the original program material *while you are recording*.

Since there are many types and varieties of tape devices, we have included the following definitions to help guide you in making the proper connections for your particular machine:

(1) A **tape recorder** is a complete, self-contained device. It has the recording amplifiers necessary for making tape recordings directly from the RCDR OUT jacks of the receiver. It also has its own playback amplifiers and speakers, but—in most cases—it can be connected to the MON IN jacks of the receiver for improved playback quality. If the recorder uses different circuits and heads for recording than it does for playback, these same MON IN jacks can also be used to monitor the quality of the recorded signal while you are recording. Keep in mind that not all tape recorders have tape-monitoring provisions; please consult your recorder's Instruction Manual and make absolutely certain that it has this feature before you attempt to monitor. Refer to the paragraph entitled *TAPE RECORDERS AND TAPE DECKS* for further details.

(2) A **tape deck** contains recording and playback preamplifiers only. Like a tape recorder, it can make recordings directly from the receiver's RCDR OUT jacks. Unlike a tape recorder, it *must* be connected to the MON IN jacks of the receiver for playback. If the tape deck uses different circuits and heads for recording than it does for playback, it too can be monitored through the receiver's MON IN jacks while you are recording. Please consult your tape deck's Instruction Manual and make absolutely certain that it has this feature before you attempt to monitor. Refer to the paragraph entitled *TAPE RECORDERS AND TAPE DECKS* for further details.

(3) A **tape player**, as its name implies, is intended only for playback of commercially pre-recorded tapes or tapes previously recorded on another machine. Since it usually has self-contained playback preamplifiers, it should be connected to the MON IN jacks of the receiver for playback. Refer to the paragraph entitled *TAPE PLAYERS* for further details.

(4) A **tape transport** contains no electronics. Like a tape player, it is intended only for playback of pre-recorded tapes. However, since it has no self-contained preamplifiers, it *must* be connected to the TAPE HEAD inputs of the receiver to obtain the extra measure of amplification necessary. Refer to the paragraph entitled *TAPE TRANSPORTS* for further details.

TAPE RECORDERS AND TAPE DECKS — To record and play back through this receiver, proceed as follows:

(1) If the tape recorder or deck is equipped to make stereo recordings, connect the receiver's left-channel and right-channel RCDR OUT jacks to the tape unit's left-channel (A or 1) and right-channel (B or 2) *high-level* inputs, respectively (Figure 1). Depending on your specific tape unit, these high-level inputs may be marked HIGH LEVEL, LINE INPUT, PHONO, P.U., GRAM, or the like. If the tape unit is monophonic, connect only the left-channel RCDR OUT jack on the receiver to the tape unit's single high-level input. In either case, *do not* connect the receiver to any input on the tape unit marked MIC., MICROPHONE, RADIO or DIODE.

(2) If the tape unit is stereophonic, connect its left-channel (A or 1) and right-channel (B or 2) outputs to the receiver's left-channel and right-channel MON IN jacks, respectively (Figure 1). Depending on your specific tape unit, these outputs may be marked CATHODE FOLLOWER, LINE OUTPUT, MONITOR, EXTERNAL AMPLIFIER or the like. If the tape unit is monophonic, connect its single output to the receiver's left-channel MON IN jack only.

(3) Connect the tape unit's power cord to a standard wall outlet or to a free outlet on the rear panel of the receiver. In either case, keep the power cord as far as possible from the shielded cables that go to the receiver.

(4) As usual, choose the desired program source with the receiver's SELECTOR switch; *whatever source you listen to is the source that will be recorded*. If both the program source and the tape unit are stereophonic and you intend to make a stereo tape recording, set the MODE/TAPE MONITOR switch to STEREO (or to STEREO FILTER if the source is noisy). On the other hand, if the program source or tape unit (or both) are monophonic, always set the MODE/TAPE MONITOR switch to MONO while recording; this will provide a full, blended monophonic signal to the recorder as well as permit you to hear the program source through *both* speakers.

NOTE: These are the only two controls that have any effect on tape recordings to be made from this receiver. All other receiver controls and switches may be adjusted to suit your personal tastes and listening conditions as they would be during normal operation.

(5) Follow the Instruction Manual included with the tape unit and make a trial recording. Set the tape unit's VOLUME or LEVEL control to obtain a satisfactory recording-level indication.

(6) To play back tape recordings through the receiver, set the MODE/TAPE MONITOR switch as follows:

- (a) For stereo tapes, set the switch to STEREO TAPE.
- (b) For mono tapes played on a mono machine, set the switch to TAPE L; this will permit you to hear the tape through both speakers in a given listening area.
- (c) For mono tapes played on a four-track stereo/mono machine, set the switch to TAPE L (to play track 1 or track 4) or to TAPE R (to play track 2 or track 3). Which track you hear in a given position of the switch depends, of course, on which way the tape is running through the tape machine. Refer to your recorder's Instruction Manual for further details.

In all three cases, adjust the remaining receiver controls in the usual manner to suit your personal tastes and listening conditions.

(7) The monitor procedure described in this step concerns only those recorders or decks that have true tape-monitor facilities (separate record and playback circuits and heads); do not attempt it with any tape unit that does not have this feature.

On a stereo tape-recording machine with monitor facilities, you might want to hear whether there is any difference in sound quality between the original program material and the taped version of the same material. To do this, simply alternate the setting of the MODE/TAPE MONITOR switch between STEREO (to hear the original program material as usual) and STEREO TAPE position (to hear the same material, a fraction of a second later, as it sounds on tape). This will not affect or interrupt the recording process in any way.

TAPE PLAYERS (PLAYBACK ONLY) — To play pre-recorded tapes on a tape player, proceed as follows.

(1) If the tape player is stereophonic, connect its left-channel (A or 1) and right-channel (B or 2) outputs to the receiver's left-channel and right-channel MON IN jacks, respectively. Depending on your specific player, these outputs may be marked CATHODE FOLLOWER, LINE OUTPUT, EXTERNAL AMPLIFIER or the like. If the player is monophonic, connect its single output to the receiver's left-channel MON IN jack only.

(2) Connect the tape player's power cord to a standard wall outlet or to a free outlet on the rear panel of the receiver. In either case, keep the power cord as far as possible from the shielded cables that go to the receiver.

(3) Set the receiver's MODE/TAPE MONITOR switch as follows:

- (a) For stereo tapes, switch to STEREO TAPE.
- (b) For mono tapes played on a mono machine, switch to TAPE L; this will permit you to hear the tape through both speakers.
- (c) For mono tapes played on a four-track stereo/mono machine, switch to TAPE L (to play track 1 or track 4) or to TAPE R (to play track 2 or track 3). Which track you hear in a given position of the switch depends, of course, on which way the tape is running through the tape player. Refer to your player's Instruction Manual for further details.

In all three cases, adjust the remaining receiver controls in the usual manner to suit your personal tastes and listening conditions.

TAPE TRANSPORTS (PLAYBACK ONLY) — To play pre-recorded tapes on a tape transport, proceed as follows:

(1) If the tape transport is stereophonic, remove the shorting plugs from both the left-channel and right-channel TAPE HEAD jacks on the rear panel of the receiver. (Keep these plugs for reuse in case you decide to disconnect the tape transport from the receiver at some future date; they prevent annoying noises when you use the SELECTOR switch.) Connect the left-channel (A or 1) output of the transport to the receiver's left-channel TAPE HEAD jack and the transport's right-channel (B or 2) output to the receiver's right-channel TAPE HEAD

jack. If the transport is monophonic, remove the shorting plug from the left-channel TAPE HEAD jack only; connect the transport's single output to this jack.

(2) Connect the tape transport's power cord to a standard wall outlet or to a free outlet on the rear panel of the receiver. In either case, keep this power cord as far as possible from the shielded output cables of the transport.

(3) Set the receiver's front-panel SELECTOR switch to TAPE HEAD. If the transport and the tape are stereophonic, set the MODE/TAPE MONITOR switch to STEREO (or to STEREO FILTER if the tape is noisy); if either the transport or the tape is monophonic, set the switch to MONO. Follow the directions in the transport's Instruction Manual to play a tape and adjust the receiver's VOLUME control for a comfortable listening level. Adjust all other receiver controls in the usual manner to suit your personal tastes and listening conditions.

NOTE: If you encounter severe hum while playing tapes from the transport, connect a short length of No. 18 single-conductor wire to an uncoated metal point on the transport's chassis. Connect the other end of this wire to the hex-head screw on the receiver that has the record-player ground wire connected to it (Figure 1). Experiment with several points on the transport's chassis until you find the point that produces the least hum.

AUXILIARY SOURCES

You may take advantage of the inherent versatility of this receiver by connecting an additional *high-level* stereo or mono program source to the AUX jacks on the rear panel of the receiver. With this arrangement, the receiver can be used as the control center of a complete home entertainment system.

For example, you may connect an AM-broadcast or AM-multiband (medium-wave, long-wave, short-wave) tuner or receiver. As an alternative, you may want to connect the audio output of a television receiver, sound-movie projector, electronic organ or similar device.

Make sure that the auxiliary device has medium- or high-level, high-impedance output jacks intended specifically for use with external high fidelity equipment. If it does not, consult a qualified service technician; he can make the simple modifications required. In addition, if the device has a built-in speaker, you may want him to include provisions for switching off this speaker so that it does not interfere with the sound from the speakers connected to the receiver.

CAUTION: If the auxiliary device is an AC/DC or "transformerless" type, have the service technician take adequate precautions to prevent shock or hum caused by a "hot" (electrically unisolated) chassis. Do not connect any auxiliary device to this receiver if you are in doubt about the safety characteristics of the device.

To connect an auxiliary device to the receiver, proceed as follows:

(1) If the auxiliary device is stereophonic, connect its left-channel (A or 1) and right-channel (B or 2) outputs to the receiver's left-channel and right-channel AUX input jacks, respectively. If the auxiliary device is monophonic, connect its single output to the receiver's left-channel AUX jack only.

(2) Connect the auxiliary device's power cord to a standard wall outlet or to a free outlet on the rear panel of the receiver. In either case, keep the power cord as

far as possible from the shielded cables that go to the receiver.

(3) Set the receiver's SELECTOR switch to AUX. If the auxiliary device is stereophonic, set the MODE/TAPE MONITOR switch to STEREO; if the device is monophonic, set the switch to MONO. Turn on the auxiliary device and play program material on it; adjust the receiver's VOLUME control for a comfortable listening level.

(4) Turn the receiver's SELECTOR switch back and forth between AUX and FM AUTO and listen to the relative volume levels of the two program sources—they should be approximately equal *without you having to readjust the receiver's VOLUME control each time you switch*. If the auxiliary device has any volume or level controls that affect auxiliary volume as *heard through the receiver*, adjust them, if necessary, to equalize the volume levels.

HEADPHONES

For private listening from all program sources, high-quality, low-to-medium-impedance stereo headphones may be plugged into the PHONES jack between the MODE/TAPE MONITOR and SELECTOR switches. Almost all commercial stereo headphones are equipped with the proper type of plug to fit this jack. In the rare event that yours are not, use a standard ¼-inch three-pole phone plug; connect the cable from the phones to the plug as shown in Figure 3.

When using the headphones for the first time, turn the receiver's VOLUME control to minimum and shut off the main speakers *before* plugging in the phones. Readjust the VOLUME control for a comfortable *headphone* listening level and use this control setting as a reference for future use.

CAUTION: Do not leave the headphones plugged in when playing the loudspeakers at high volume levels; the large amounts of audio power required by the speakers at these levels can overload and permanently damage the headphones.

DYNAMIC SPACEXPANDER®

The FISHER Model K-10 DYNAMIC SPACEXPANDER® is a unique reverberation device that can be used in conjunction with this receiver to recreate the acoustical environment of a large concert hall or theater in your listening room. To connect a SPACEXPANDER to this receiver, proceed as follows:

(1) Connect the receiver's left channel RCDR OUT jack to one of the channel A INPUTS on the SPACEXPANDER.

(2) Connect the receiver's right channel RCDR OUT jack to one of the channel B INPUTS on the SPACEXPANDER.

NOTE: If you have to disconnect a tape recorder or deck from the LEFT and RIGHT RCDR OUT jacks in order to accommodate the SPACEXPANDER, reconnect the recorder's high-level inputs to the extra channel A and B INPUTS on the SPACEXPANDER. This will permit you to still make tape recordings from the receiver while using the SPACEXPANDER. (The recordings, however, will not have reverberation since this effect is added *after* the point at which the recorder is connected.) Refer to the SPACEXPANDER Manual for further details.

(3) Connect the receiver's left channel MON IN jack to the channel A OUTPUT jack on the SPACEXPANDER.

(4) Connect the receiver's right channel MON IN jack to the channel B or C OUTPUT jack on the SPACEXPANDER.

(5) Set the receiver's MODE/TAPE MONITOR switch to STEREO TAPE and keep it in this position whenever you use the SPACEEXPANDER.

When the SPACEEXPANDER is turned off or disconnected, set this switch to STEREO or MONO; otherwise all program sources played through the amplifier will be silenced.

NOTE: If you have to disconnect a tape recorder, deck, or player from the receiver's MON IN jacks in order to accommodate the SPACEEXPANDER—and you still wish to play tapes through the receiver—connect the tape unit to the receiver's AUX jacks (if they are presently not in use) and use the AUX position of the SELECTOR switch for tape playback (but not monitoring).

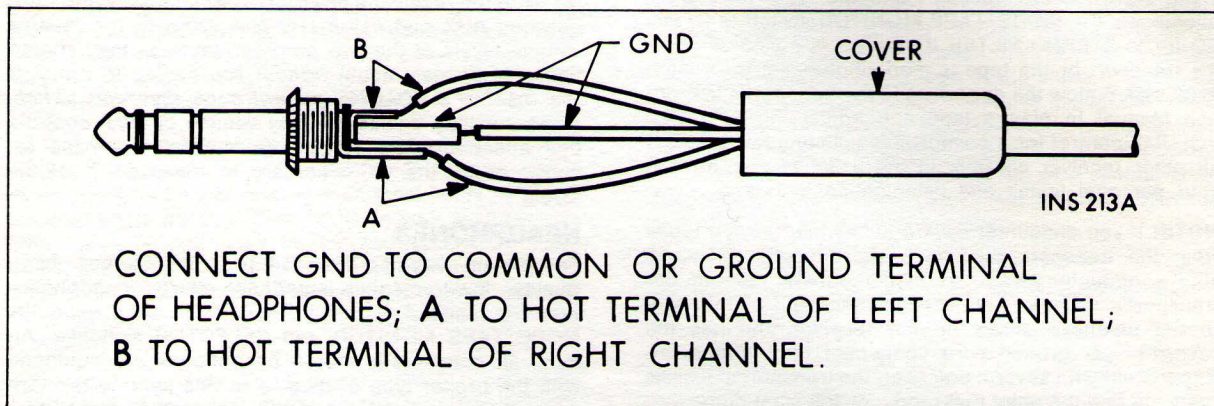

Figure 3. Headphone Plug Connections

CUSTOM INSTALLATION

This receiver may be installed in a custom cabinet or console of your own choice provided that you follow the general precautions and detailed installation instructions included in this section. Remember that heat is the greatest enemy of electronic equipment; heat from a nearby component or a radiator could be great enough to degrade the performance of the receiver or cause premature parts failure. For this reason, as well as for the sake of electrical and mechanical safety, it is absolutely essential that you observe the following precautions:

(1) Do not place the custom cabinet near a radiator, warm-air duct or other source of heat. To permit cooling air to circulate around and *through* the receiver chassis, keep the rear of the cabinet open and at least a few inches away from a wall or other obstruction; also, raise the receiver chassis from the mounting shelf with wood cleats (as specified in the installation instructions that follow). If another heat-producing component, such as an amplifier, is installed in the same cabinet, mount it *above* the receiver. If you install the receiver vertically, you *must* use a fan capable of delivering at *least* 65 cubic feet of air per minute. In any event, the ambient air temperature in the area of the receiver chassis should not exceed 40° Centigrade or 104° Fahrenheit.

(2) *Before* installing the receiver, unscrew the four plastic feet from its bottom cover, but keep them for re-use in case you decide to remove the receiver from the cabinet and place it on an open shelf or table at some later date. These feet *must* be re-installed in such cases.

(3) You will need two flat-head wood screws to fasten the cleats to the mounting shelf in your custom cabinet. Depending on the thickness of the mounting shelf, you will also need four 1½-inch or 1¾-inch 8-32 machine screws with washers to fasten the receiver chassis to the cleats and mounting shelf; these items are available at any hardware store. In any event, the machine screws *must not* protrude more than ¼ inch above the cleats; greater lengths may damage delicate parts or cause short circuits inside the receiver chassis. *Before* installing the receiver, compare the length of a sample screw with the combined thickness of the mounting shelf and one of the ¾-inch cleats to make sure that the screw meets this requirement; use the washers, if necessary, to take up any excess length.

NOTE: If you intend to install the receiver vertically you will need at least 14 No. 8, 1¼-inch round-head wood screws in addition to the hardware mentioned above.

FAILURE TO OBSERVE THESE PRECAUTIONS WILL VOID ALL WARRANTIES ON THIS UNIT.

HORIZONTAL INSTALLATION

(1) Figure 4a is an overall view of the completed horizontal installation, showing the relationship of the custom cabinet, receiver chassis, mounting shelf, and cleats. Study it carefully so that you get a clear idea of the general requirements of the installation.

(2) Figure 4b is a top view of the installation, showing optional vent holes (represented by shaded areas) in the mounting shelf that provide additional ventilation to the underside of the receiver chassis. If you choose to use them, measure the locations and dimensions of vent holes 1, 2, and 3 *only* and saw them out.

(3) Cut two cleats 12 inches long from a piece of $\frac{3}{4}$ -inch square wood stock.

(4) Fasten the cleats to the mounting shelf with the two flat-head wood screws at the points marked A in Figure 4b. If possible, insert the screws from the underside of the mounting shelf; if you must drive the screws from above, make certain that the screw heads are countersunk below the top surfaces of the cleats.

(5) Locate and drill four $\frac{5}{16}$ -inch holes as shown at the points marked B in Figure 4b.

(6) Saw a cutout through the front panel of your custom cabinet to the dimensions shown in Figure 4c. Make certain that the bottom edge of the cutout is the same height above the mounting shelf as the tops of the cleats.

(7) Make sure that the plastic feet have been removed from the receiver. Slide the receiver chassis into the custom-cabinet cutout until the receiver's front panel is tight against the cabinet's front panel and hides the rough edges of the cutout.

(8) Insert the four appropriately sized machine screws (with washers, if necessary) into the holes on the underside of the mounting shelf and fasten the receiver chassis into place. Remember, make certain that the screws do not penetrate more than $\frac{1}{4}$ -inch into the chassis.

VERTICAL INSTALLATION

CAUTION: Once again let us remind you not to attempt to install this receiver vertically unless you use both an open-back cabinet and a fan capable of providing a minimum of 65 cubic feet of air per minute and unless you install the chassis and the fan exactly as specified in the following instructions. OUR WARRANTY DOES NOT COVER DAMAGE CAUSED BY EXCESSIVE HEAT BUILD-UP.

(1) Figure 5a is an overall view of the completed vertical installation, showing the relationship of the custom cabinet, receiver chassis, mounting board, cleats, and the fan. Study it carefully so that you get a clear idea of the general requirements of the installation.

Measure the inside height of the cabinet and compare this height with the overall depth (front panel to fuse post) of the receiver chassis; the cabinet must be high enough to provide *at least* the 4-inch clearance shown between the chassis and the bottom of the cabinet. Also, make sure that there will be enough room in front of the mounting board for the fan.

(2) Determine where in the cabinet you want to install the receiver and check beneath the top panel of the cabinet for obstructions. Saw a cutout in the top panel to

the dimensions shown in Figure 5b. Make a pencil mark at the mid-point of one of the long sides of the cutout as shown.

(3) Measure the inside width of the cabinet (or mounting compartment) as shown in Figure 5b. Cut a chassis-mounting board from $\frac{3}{4}$ -inch plywood so that it is $\frac{1}{4}$ -inch narrower than the inside width of the cabinet; this will provide the necessary $\frac{1}{8}$ -inch clearance at each edge as shown. The other dimension of the board should be an inch or two greater than the overall depth (front panel to fuse post) of the receiver chassis.

(4) Hold the mounting board horizontally so that it is flat against the underside of the cabinet's top panel. Position the board so that it clears each side wall of the cabinet (or mounting compartment) by the required $\frac{1}{8}$ -inch. Extend the pencil mark at the edge of the cutout across the exposed part of the mounting board. Using this pencil mark as one of the necessary references, lay out the locations and dimensions of vent holes 1, 2, and 3 *only* (shown in Figure 4b) and saw them out. **These holes are mandatory for vertical installation.**

(5) Cut two cleats 12 inches long (cleats 1 and 2) from a piece $\frac{3}{4}$ -inch square wood stock. Lay out the locations of the cleats on the mounting board as shown in Figure 4b. Fasten the cleats to the board with the two flat-head wood screws at the points marked A in the illustration. If you drive the screws through the cleats from above, make sure that the screw heads are countersunk below the top surfaces of the cleats.

(6) Locate and drill four $\frac{5}{16}$ -inch holes through the cleats and board as shown at the points marked B in Figure 4b.

(7) To determine the locations of cleats 3 and 4, place the mounting board in the cabinet *vertically* so that cleats 1 and 2 line up with the forward edge of the cutout as shown in Figure 5b. Measure the distance between this edge of the cutout and the forward edge of the mounting board as shown in the illustration; do this on the both side walls of the cabinet (or mounting compartment) and make pencil marks at the appropriate points.

(8) Cut two cleats $12\frac{7}{8}$ inches long (cleats 3 and 4) from a piece of 1-inch square wood stock. Drill four $\frac{5}{16}$ -inch pilot holes, spaced about four inches apart, through cleat 3. Turn the cleat 90 degrees and drill three more $\frac{5}{16}$ -inch holes; space the holes about four inches apart so that each hole is about midway between any two holes that are at right angles to it. Repeat this procedure for cleat 4.

(9) Hold cleat 3 at its appropriately marked location on one of the inside walls of the cabinet (or mounting compartment). Make sure that the cleat is perpendicular to the top panel and about $\frac{1}{2}$ inch below it. Using the three $\frac{5}{16}$ -inch holes as guides, locate and drill three $\frac{5}{16}$ -inch pilot holes in the side wall of the cabinet, about $\frac{1}{4}$ inch deep. Repeat this procedure with cleat 4. Mount both cleats inside the cabinet with six No. 8, $1\frac{1}{4}$ -inch round-head wood screws.

(10) Mount the fan as shown so that its axis will point at the center of the cutout areas on the mounting board when the board is placed in the correct position. You may fasten the fan to a separate mounting board or to standoffs on the receiver mounting board but make sure that it is no more than 4 inches from the main board and that it is oriented to blow air *towards* the chassis.

(A)

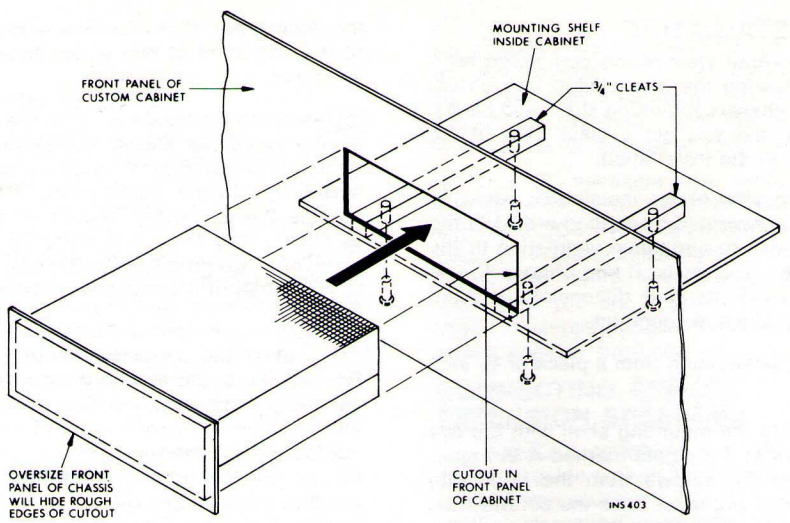

(B)

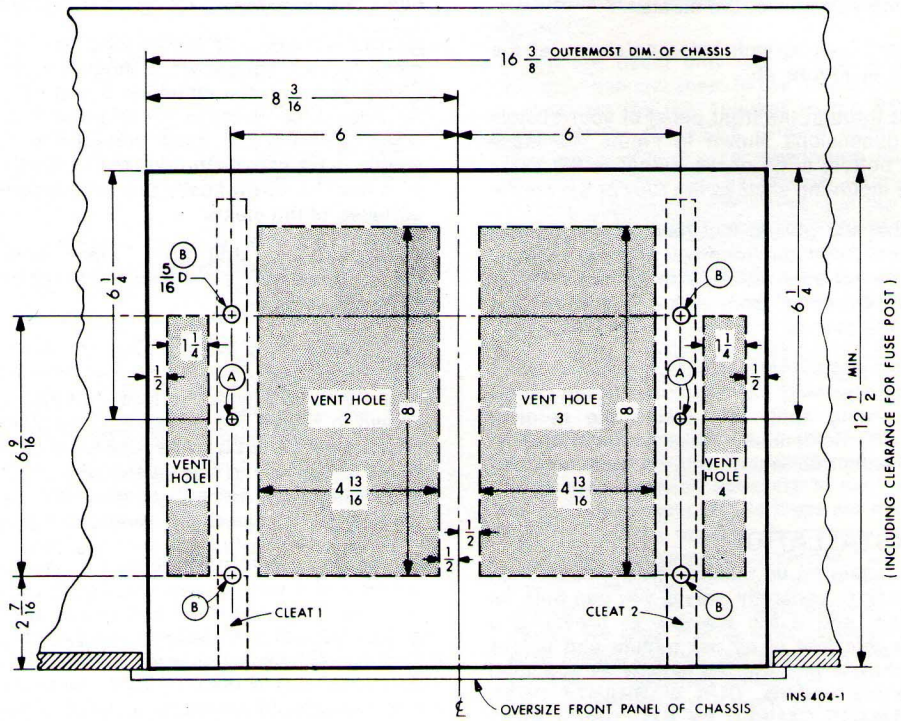

(C)

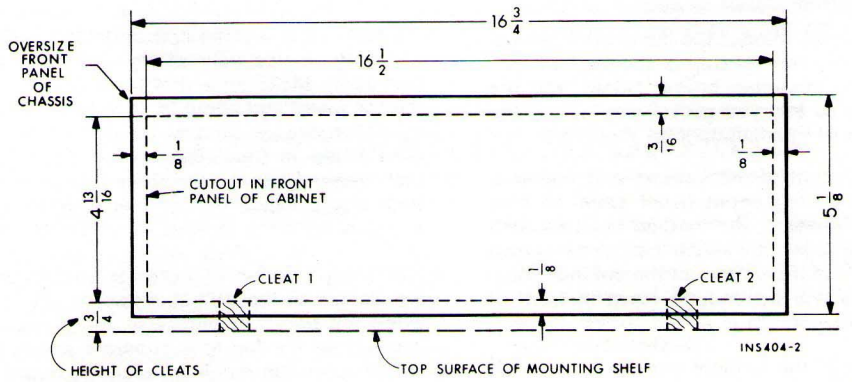

Figure 4. Horizontal Installation

(11) Make sure that the plastic feet have been removed from the receiver. Gently remove the receiver's control knobs and the hex nuts (on the control-shaft bushings) that hold the front panel to the rest of the receiver chassis; lift off the front panel.

(12) Insert three 1 $\frac{3}{4}$ -inch 8-32 machine screws (with washers, if necessary) into the holes on the underside of the mounting board and fasten the receiver chassis into place. Remember, make certain that the screws do not penetrate more than $\frac{1}{4}$ inch into the chassis.

(13) Fasten the mounting board to cleats 3 and 4 using

eight No. 8 1 $\frac{1}{4}$ -inch roundhead wood screws; support the mounting board while doing this and make sure that the top edge of the board is tight against the underside of the cabinet's top panel. Replace the receiver's front panel, hex nuts and control knobs.

(14) The fan *must* be connected to one of the outlets on the rear panel of the receiver; if both outlets are presently in use, disconnect a component from one of these outlets and connect the fan in its place. This will ensure that the fan is on whenever the receiver is switched on. If the fan has its own power switch, make sure that it is permanently switched ON.

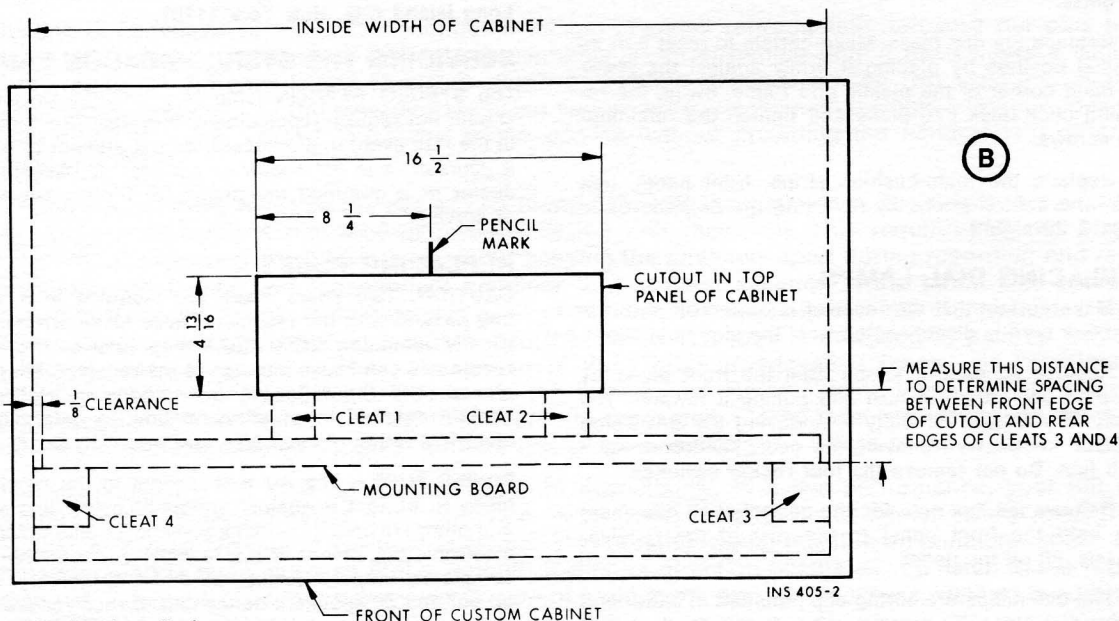
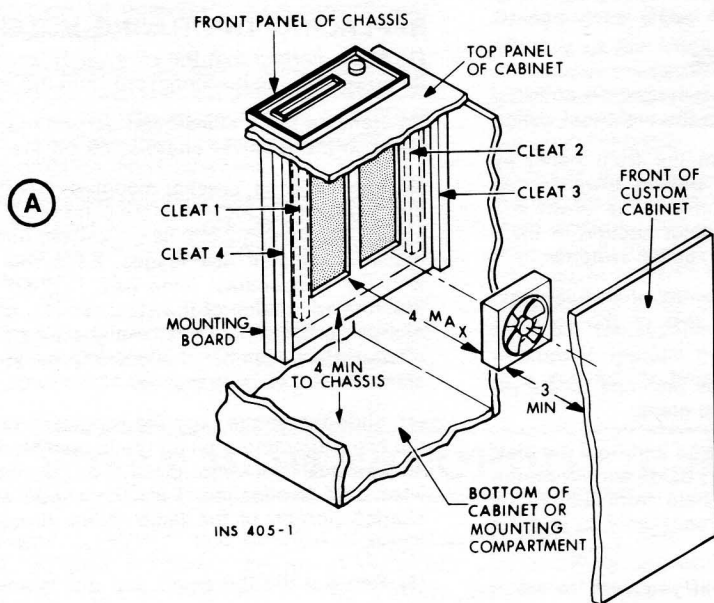

Figure 5. Vertical Installation

CAUTION: Disconnect the receiver's power cord from the electrical outlet before performing any of the following maintenance or replacement procedures.

CLEANING THE FRONT PANEL

The beautiful gold plating on the control panel borders will retain its color and brilliance permanently. However, it is possible that, over a period of time, a film from atmospheric contamination may dull the surface. Simply use a soft *freshly-laundered* cloth dampened with *plain lukewarm water* to wipe it clean and the panel will look new again. **Do not use any household cleaning agents or any cloth that has been used to apply such agents.**

CLEANING THE DIAL GLASS

(1) Make certain that the receiver is turned off and that its power cord is disconnected from the electrical outlet.

(2) Remove all control knobs from the front panel by grasping each knob in turn and pulling towards you *gently*. If you have difficulty in removing the BASS and TREBLE knobs, try removing the outer section of each knob first. **Do not remove the four rocker switches.**

(3) Remove the hex nuts (on the control-shaft bushings) that hold the front panel to the rest of the receiver chassis; lift off the panel.

(4) Remove the foam-cushion strips fastened to the retaining clips at either end of the dial glass.

(5) Loosen (do not remove) the screws that hold the dial-glass retaining clips; swing the clips aside and lift off the dial glass. Because the glass is held from behind by adhesive rubber strips, it may be necessary to apply a gentle prying force at the ends.

(6) Remove dust with a dry rag. If you wish to clean more thoroughly, use a **soap-and-water solution only**; a stronger cleaning agent may damage the markings on the glass.

(7) Replace the dial glass. Make certain to reset it in its original position by placing it firmly against the *lower left-hand* corner of the plastic end frame. Swing the retaining clips back into place and tighten the retaining-clip screws.

(8) Replace the foam-cushion strips, front panel, hex nuts, and control knobs by reversing the procedures in steps 2 through 4.

REPLACING DIAL LAMPS

(1) Make certain that the receiver is turned off and that its power cord is disconnected from the electrical outlet.

(2) Remove all control knobs from the front panel by grasping each knob in turn and pulling it towards you *gently*. If you have difficulty in removing the BASS and TREBLE knobs, try removing the outer section of each knob first. **Do not remove the four rocker switches.**

(3) Remove the hex nuts (on the control-shaft bushings) that hold the front panel to the rest of the receiver chassis; lift off the panel.

(4) The dial lamps are spring-clip mounted at either end of the dial glass. To remove either lamp, gently pull it

out of its clip mount. Replace it with the new dial lamp (Part Number I50441-1*) making certain that the *unpainted* side of the lamp faces *towards* the edge of the dial glass.

(5) Replace the front panel, hex nuts, and control knobs by reversing the procedures given in steps 2 and 3.

***NOTE: Replacement lamps may be ordered from your authorized FISHER dealer or from: Parts Department, Fisher Radio Corporation, 11-40 45 Road, Long Island City, New York 11101.**

REPLACING THE TUNING-METER LAMP

(1) Make certain that the receiver is turned off and that its power cord is disconnected from the electrical outlet.

(2) Remove the Phillips-head screws that fasten the top cover to the receiver chassis; lift off the cover.

(3) The lamp is bracket-mounted directly behind the tuning meter. Remove the lamp (together with its metal shade) by pushing it into its socket and turning it *counterclockwise* until it disengages. Keep the shade for use with the replacement lamp (No. 1847-OF, an extended-life, frosted version of the standard No. 47 lamp). If your dealer cannot supply this item you may order it from us (Fisher Part Number I-50009-8*) or you may use a standard No. 47 lamp instead.

(4) Slide the shade onto the replacement lamp. Line up the two projecting pins on the lamp with the slots on the socket; push the lamp into the socket and turn it clockwise until it engages. Turn the shade so that the unshaded portion of the lamp faces directly towards the meter.

(5) Replace the top cover and Phillips-head screws.

***NOTE: Replacement lamps may be ordered from: Parts Department, Fisher Radio Corporation, 11-40 45 Road, Long Island City, New York 11101.**

SERVICING THE STEREO BEACON LAMP

The STEREO BEACON lamp is a long-life device that should not require replacement in normal use. However, in the rare event that it should, do not attempt to replace it yourself; it *is not* customer serviceable. Consult your dealer or a qualified technician for further information or service.

REPLACING FUSES

CAUTION: Two spare fuses are included in a plastic bag packed with the receiver. These fuses are not electrically identical; using the wrong fuse in the wrong receptacle can cause damage to the receiver. Therefore, please read the following instructions carefully; they contain detailed information on how to determine the electrical rating of each fuse and where to use it.

POWER FUSE — The AC power input to the receiver is fused to protect it against abnormal power-line surges and other adverse conditions sometimes encountered by electronic equipment. If the receiver suddenly becomes completely inoperative (i.e., all dial and indicator lamps go out and all speakers connected to receiver are silent at all settings of SELECTOR switch, SPEAKERS switch

and VOLUME control), this is an indication that the power fuse in the rear-panel black receptacle marked AC LINE SLO-BLO may have blown. To replace it, proceed as follows:

- (1) Make certain that the receiver is turned off and that its power cord is disconnected from the electrical outlet.
- (2) Push the fuseholder cap in and turn it counterclockwise until it disengages; extract it from the receptacle and remove the fuse from the cap.
- (3) One of the fuses in the plastic bag has a short spiral coil of wire inside its glass envelope. (This coil identifies it as a slow-blow type.) Depending on the AC voltage for which your receiver was wired, one of the metal ends of the fuse will be marked 2 A 125 V (for 105-120 volts) or 1 A, 250 V (for 210-240 volts). Use only this fuse (or an exact commercial equivalent) as a replacement for the blown power fuse.
- (4) Insert the replacement fuse into the fuse cap. Line up the flanges on the cap with the notches inside the receptacle; push the cap into the receptacle and turn it clockwise until it engages. Plug the power cord into the electrical outlet and turn the receiver on.

CAUTION: If the receiver still does not operate or if the replacement fuse blows immediately, do not attempt to replace the fuse again. Consult your dealer or a qualified technician.

OUTPUT FUSE — The output transistors and power supply of this receiver are fused to protect them against damage that might otherwise occur because of short circuits in the wiring between the receiver and the speakers.

If there is suddenly no sound from the speakers while the receiver appears to be operating normally in every other respect, this is an indication that the fuse in the SPKR 4A receptacle on the rear panel of the receiver may have blown. **Before you attempt to replace this fuse, try to find out what caused it to blow as described in the following instructions:**

- (1) Make certain that the receiver is turned off and that its power cord is disconnected from the electrical outlet.
- (2) Check all connections on the LEFT SPKRS and RIGHT SPKRS terminal strips on the receiver and at the terminals on the speakers themselves. Look especially for loose strands of wire that may be shorting one terminal to an adjacent terminal or to the chassis of the receiver.
- (3) Push in the fuseholder cap and turn it counterclockwise until it disengages; extract it from the receptacle and remove the fuse from the cap.
- (4) One of the fuses in the plastic bag has one of its metal ends marked 4 A, 250 V. Use only this fuse (or an exact commercial equivalent) as a replacement for the blown fuse. Do not use slow-blow fuses of the same rating as substitutes.
- (5) Insert the replacement fuse in the fuse cap. Line up the flanges on the cap with the notches inside the receptacle; push the cap into the receptacle and turn it clockwise until it engages. Plug the power cord into the electrical outlet and turn the receiver on.

CAUTION: If there is still no sound from the speakers or if the replacement fuse blows immediately, do not attempt to replace the fuse again. Consult your dealer or a qualified technician.

WHAT IS STEREOPHONIC SOUND?

Stereophonic sound (stereo) is a method of reproducing sound by means of two independent channels, left and right, so that a spatial feeling of direction and depth is recreated. It is the extension of high fidelity sound into three dimensions. In fact, it offers the closest approach to true high fidelity yet achieved because it comes closest to the ultimate aim of all high fidelity systems—a perfect recreation of the original live sounds. Thus, good stereophonic sound *is* high fidelity in the truest sense of the term.

This feeling of dimension is lost with monophonic (single channel) reproduction, because our ears help determine the relative position of separate instruments in an ensemble only if each hears a slightly different version of the sound, just as visual depth perception depends on the two separate, slightly different pictures received by the eyes. Merely using two or more speakers on a single amplifier does not solve the problem; it only spreads the single sound source without providing the all-important different "aural viewpoints."

True stereo sound, then, requires the use of two independent sound paths from the origin to your ears, kept separate at all times during recording, transmission and reception. This requires the use of two separate sets of recording amplifiers, a means of keeping the channels apart during recording and radio broadcasting, and finally, two independent amplifier and speaker systems in the home. For optimum stereo, it is best to have the equipment used in each channel as alike as possible. In a stereo record, each wall of the groove contains a separate signal, and the stereo cartridge is designed to pick up each of these two channels separately. The new system of FM stereo broadcasting (known as "multiplex") utilizes a separate ultrasonic signal, in addition to the main signal. By combining these two signals in a multiplex decoder, the original left and right channels are recovered. Stereo tape recordings are made by impressing the two channels on separate parallel tracks running along the length of the tape.

The two channels are not kept completely separate acoustically. In a live performance, your left ear hears many of the sounds on your right, and vice versa. Thus, keeping the channels totally apart from the original recording session to the final playback in your home would result in an unnatural effect. But enough separation is maintained so that a definite feeling of direction occurs as you listen to the reproduced sound. The result is a remarkably vivid illusion of great depth and spaciousness, such as is normally obtained only at a live performance.

FM MULTIPLEX STEREO

FM broadcasting has a frequency range far in excess of the normal hearing range. For example, Fisher wide-band tuners have a frequency range which extends to 75 kHz (kc), while the normal hearing range does not exceed 17 kHz (kc). This extra "space" in the frequency range has now been put into service for the transmission of a second and third signal simultaneously with the main signal. The third (and highest frequency) signal is used in commercial applications (for background music) and will not be received on home high fidelity equipment. The other two signals, however, are used for the reception of stereo programs. During stereo multiplex broadcasts, the main signal, which can be received by any FM tuner or receiver, contains the sum or blended signal from both stereo channels (left plus right). The second, ultrasonic signal contains the additional information necessary to recreate the stereophonic sound. This "compatible" system makes it possible for an ordinary FM set to receive a fully balanced monophonic program even during a stereo multiplex broadcast. At the same time, however, the multiplex circuits of the 500-T derive the left and right stereo channels from the main and ultrasonic signals, thus providing you with all the added realism of full stereo sound.

Because FM stereo multiplex broadcasts require new equipment and new techniques at FM stations, it is to be expected that not all programs will be of the same technical caliber during the first few months of their operation. Such occasional problems as may arise initially will no doubt be solved quickly, as the stations gain experience with the new procedures.

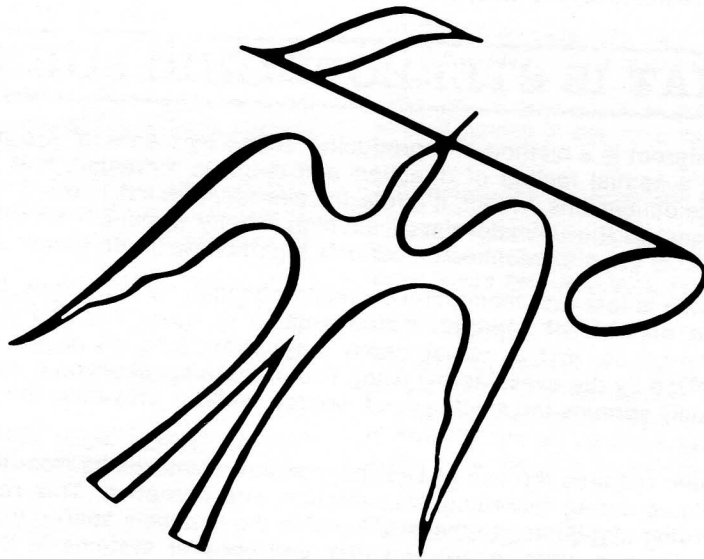

TECHNICAL SPECIFICATIONS

FM TUNER SECTION

Usable Sensitivity (IHF Standard)	1.8 uV
Harmonic Distortion (at 400 Hz, 100% Modulation)	0.4%
Signal-to-Noise Ratio (at 100% modulation and 1 mV input)	70 db
Selectivity, Alternate Channel, IHF	50 db
Spurious Response Rejection (at 100 MHz)	90 db
Image Frequency Rejection (at 100 MHz)	80 db
IF Frequency Rejection (at 100 MHz)	95 db
FM Stereo Separation (at 1 kHz)	40 db
Capture Ratio, IHF	2 db

AMPLIFIER SECTION

Music Power, IHF (at 1 kHz)	
Speaker impedance 4 ohms	90 watts
Speaker impedance 8 ohms	70 watts
RMS Power (at 1 kHz)	
Speaker impedance 4 ohms	32/32 watts
Speaker impedance 8 ohms	26/26 watts
Harmonic Distortion (at 1 kHz)	0.8%
IM Distortion (60/7000 Hz, 4:1; SMPTE)	0.8%
Power Bandwidth, IHF (at 8 ohms)	22 to 30,000 Hz
Sensitivity (for rated output at 4 ohms)	
Phono Low	3.5 mV
Phono High	10 mV
Tape Head	2.5 mV
Auxiliary	200 mV
Monitor	250 mV
Recorder Output	250 mV
Hum and Noise (below rated output)	
Volume at minimum	-80 db
Phono Low (6-mV reference)	-55 db
Auxiliary (400-mV reference)	-65 db

Frequency Response

Phono Low	30 to 15,000 Hz ± 1 db
Auxiliary	22 to 20,000 Hz ± 1 db
Power Amplifier Section	15 to 60,000 Hz + 0, -1 db

Maximum Input Signal (at 1% THD)

Auxiliary	2.5 volts
-----------	-----------

Input Impedance

Phono Low	50 k ohms
Tape Head	100 k ohms
Auxiliary	220 k ohms

Damping Factor

Speaker impedance 4 ohms	greater than 12
Speaker impedance 8 ohms	greater than 50

Control Tracking Error (0 to -50 db)

Less than 2 db

Separation (at 1 kHz, L to R, R to L)

Phono	greater than 45 db
Tape Head	greater than 45 db
Auxiliary	greater than 45 db

Bass Control Range (at 50 Hz)

26 db

Treble Control Range (at 10 kHz)

22 db

Subsonic Filter

12 db per octave below 20 Hz

High-Frequency Filter (12 db per octave)

-3 db at 5.5 kHz

GENERAL

Dimensions (including control knobs, dress panel, and fuse post)	16¾" wide 5½" high 12¾" deep
Weight	22 lbs.
Power Consumption, Maximum	180 watts/190 VA

***NOTE:** The units of frequency measurement, cps, kc, and mc, may be replaced by the designations Hz (Hertz), kHz, and MHz, respectively. These new designations, already in standard use throughout the rest of the world, have recently been adopted by the Institute of Electrical and Electronic Engineers (IEEE).

BECAUSE ITS PRODUCTS ARE SUBJECT TO CONTINUOUS IMPROVEMENT, FISHER RADIO CORPORATION RESERVES THE RIGHT TO MODIFY ANY DESIGN OR SPECIFICATION WITHOUT NOTICE AND WITHOUT INCURRING ANY OBLIGATION.

WARRANTY TO OWNER

The warranty on a product reflects the confidence of its maker in the quality of materials and workmanship that go into it. The unique FISHER warranty has been established to protect your investment. Please read it carefully.

All FISHER equipment is fully guaranteed to the original using purchaser against defects in materials and workmanship, subject to the following:

All parts (except tubes) are guaranteed for two years. Tubes are guaranteed for one year. Any defective part will be repaired or replaced without charge. During the first ninety days there is no charge for warranty labor.

Defective parts or equipment must be returned properly packed, transportation prepaid, to the FISHER dealer from whom it was originally purchased, or to a FISHER Authorized Service Center, or, after written authorization, to the FISHER plant. All warranty service is F.O.B. the dealer, service center, or FISHER plant.

The warranty is void if our inspection shows that the equipment has been tampered with, or installed, altered or repaired at variance with factory-designated procedures, subjected to negligence, misuse or accident, damaged by excessive line voltage or insufficient ventilation, or had its serial number altered, defaced or removed.

This warranty is in lieu of all other warranties, express or implied, and all other obligations or liabilities on the part of FISHER. No person, including any dealer, agent or representative of FISHER, is authorized to assume for FISHER any liability on its behalf or in its name except to refer purchasers to this warranty.

This warranty takes effect only if the warranty-registration card has been fully and properly filled out and returned to FISHER RADIO CORPORATION within ten (10) days from the date of purchase.

Be Sure to Register Your FISHER Equipment and Enjoy the Following Advantages:

- Full benefits of the FISHER warranty.
- Prompt handling of correspondence with our Customer Service Department.
- Assistance in finding your equipment or establishing its value in case of loss through theft, fire, etc.
- Receipt of FISHER news bulletins on important developments in high fidelity equipment.

FOR WARRANTY SERVICE, CONSULT YOUR DEALER