

Service Manual

AM/FM STEREO RECEIVER

SX-424 / KUW, FVZW, KCW, FW, NBW

NOTE

MODEL SX-424 COMES IN FIVE VERSIONS DISTINGUISHED AS FOLLOWS:

Round label on rear panel	Voltage	Type
KUW	120V only	UL approved (U.S.A.)
FVZW	5-position selector	FTZ approved (West Germany)
KCW	120V only	CSA approved (Canada)
NBW	220V only	SEMCO (Sweden), DEMCO (Denmark), and NEMCO (Norway) approved
FW	5-position selector	General export model with de-emphasis selector switch

PIONEER®

CONTENTS

1. SPECIFICATIONS 1

2. FRONT PANEL FACILITIES 3

3. CONNECTION DIAGRAM 5

4. DISASSEMBLY 7

5. PARTS AND PCB LOCATION

 TOP VIEW 8

 BOTTOM VIEW 8

6. DIAL CORD STRINGING 9

7. ALIGNMENT PROCEDURE

 7.1 FM/AM IF ALIGNMENT 10

 7.2 FM/AM TRACKING ALIGNMENT 10

 7.3 MPX DECODER ALIGNMENT 11

 7.4 OTHER ALIGNMENT 11

8. PACKING METHOD AND PART NUMBERS..... 12

9. SCHEMATIC DIAGRAMS, PCB PATTERNS AND PARTS LIST

 9.1 UNIT CONNECTION DIAGRAM AND MISCELLANEOUS PARTS 13

 9.2 TUNER UNIT 27

 9.3 AF UNIT 33



HOW TO USE SERVICE MANUAL FOR MODEL SX-424

This service manual applies to five models as follows:

- FVZW model numbered on and after Serial No. 1602501
- KUW model numbered on and after Serial No. 3802601
- KUW, FW, NBW models available at all serial numbers without any limit.

As for FVZW and KUW models numbered before Serial Nos. 1602501 and 3802601, respectively, refer to the manual (R42-241-0 printed on the cover's upper right) for model SX-424/KUW, FVZW.

1. SPECIFICATIONS

SEMICONDUCTORS

FETs	1
Transistors	30
Diodes	24

AMPLIFIER SECTION

Music Power Output (IHF)	50W (4Ω) 37W (8Ω)
Continuous Power Output (1kHz each channel driven)	18W/18W (4Ω) 14W/14W (8Ω)
Continuous Power Output (1kHz both channels driven)	13W + 13W (4Ω) 12W + 12W (8Ω)
Harmonic Distortion	Less than 1% (Continuous power output)
Intermodulation Distortion	Less than 1% (Continuous power output)
Power Bandwidth (IHF)	20Hz to 45kHz (8Ω, Harmonic distortion less than 1%)
Frequency Response	20Hz to 70kHz, ±3dB
Speakers	4 to 16Ω
Damping Factor	40 (8Ω, 1kHz)
Input Sensitivity/Impedance	PHONO MAG 3mV/50kΩ MIC 6.5mV/50kΩ AUX 180mV/100kΩ TAPE MONITOR 180mV/100kΩ TAPE MONITOR (DIN) 180mV/100kΩ
Recording Output	TAPE REC (Pin Jack) 180mV TAPE REC (DIN connector) 36mV
BASS Control	-9dB, +9dB/100Hz
TREBLE Control	-9dB, +6dB/10kHz
Equalization Curve	PHONO: RIAA S.T.D.
Loudness Contour	+9.5dB/100Hz, +5.5dB/10kHz with Volume Control set at -40dB position.
Hum and Noise (IHF)	PHONO: More than 75dB AUX: More than 85dB

FM TUNER SECTION

Frequency Range	88MHz to 108MHz 87.5MHz to 108MHz (FTZ approved)
Usable Sensitivity (IHF)	2.3 μ V
Capture Ratio (IHF)	3.5dB
Image Rejection	More than 50dB (98MHz)
IF Rejection	More than 80dB (90MHz)
Spurious Rejection	More than 70dB (98MHz)
AM Suppression	45dB
Signal-to-Noise Ratio	65dB
Harmonic Distortion	Mono: less than 0.6% (100% Mod.) Stereo: less than 0.8% (100% Mod.)
Tuning Indicator	Signal strength type
Stereo Separation	More than 40dB (1kHz)
Sub Carrier Suppression	More than 35dB
Noise Filter	Switchable to ON-OFF
Antenna Input	Impedance 300 Ω balanced and 75 Ω unbalanced
De-emphasis selector	50 μ S - 75 μ S (FW model only)

AM TUNER SECTION

Frequency Range	525kHz to 1,605kHz
Usable Sensitivity (IHF)	15 μ V
Image Rejection	More than 45dB (1,000kHz)
IF Rejection	More than 35dB
Signal-to-Noise Ratio	More than 50dB
Antenna	Built-in ferrite loopstick antenna

MISCELLANEOUS

Power requirements	120V 60Hz, 220V 50-60Hz or 110V, 120V, 130V 220V and 240V. (Switchable) 50-60Hz
Power Consumption	90W (Max.)
AC Outlets	Switched 1, Unswitched 1.
Dimensions (overall)	16-31/32 in./431 mm (width) 5-3/4 in./146 mm (height) 13-21/32 in./347 mm (depth)
Weight (Without package)	16 lb, 8oz/7.5 kg (120 voltage model) 17 lb, 6oz/7.9 kg
(With package)	20 lb, 14oz/9.5 kg (120 voltage model) 21 lb, 13oz/9.9 kg
Furnished Parts	FM T-type Antenna 1 Fuse: 1A 1 0.5A (5 line voltage model only) 1 Pin Plug 2 Speaker Plug 4 Polishing Cloth 1 Operating Instructions 1

NOTE: Specification and the design subject to possible modification without notice due to improvements

2. FRONT PANEL FACILITIES

SPEAKERS SWITCH

A combination of the power on/off switch and the speaker system selector switch.

POWER

OFF The equipment is dead.

A Sound comes through the speaker system A.

SPKR OFF No sound from any speaker system.
Useful for listening through headphones.

B Speaker system B is in operation.

A+B Both speaker systems A and B are in operation.

PHONES JACK

For plugging in stereo headphones.

A variety of high-performance headphones is available from Pioneer.

BASS & TREBLE CONTROLS

Control bass and treble. Turning each control clockwise from the FLAT position will boost the tone, and turning it counterclockwise will diminish the tone.

VOLUME CONTROL

The volume increases when this dual-concentric control is turned clockwise and decreases when the control is turned counterclockwise. Both parts of the knob usually rotate together. To adjust the volume of either the right or left channel alone, hold one part of the control knob with one hand and turn the other with the other hand. Convenient in balancing the volume of both channels. The front knob is for the left channel, the rear one for the right.

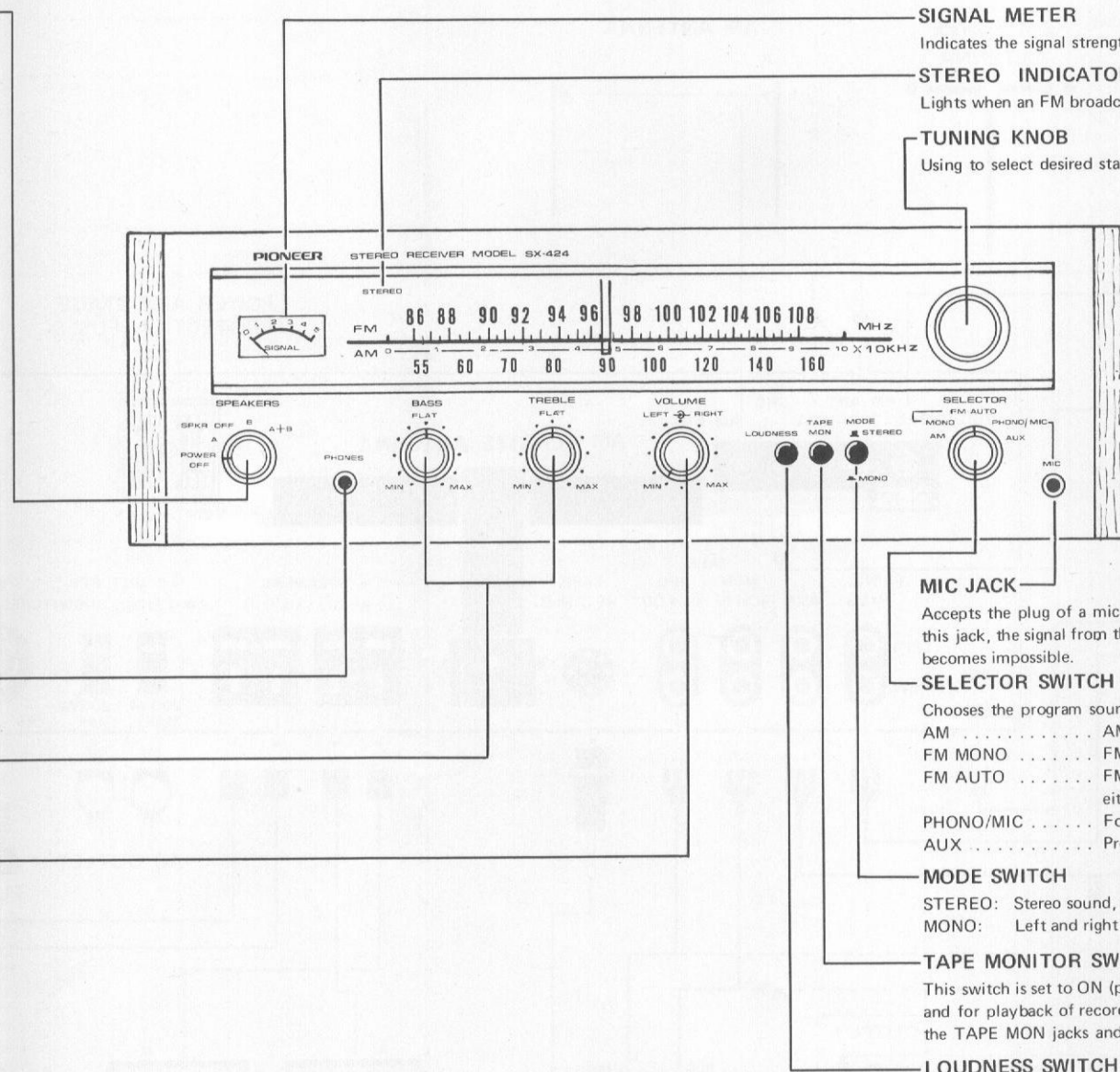

SIGNAL METER

Indicates the signal strength of the received AM or FM station.

STEREO INDICATOR

Lights when an FM broadcast is in stereo.

TUNING KNOB

Using to select desired stations.

MIC JACK

Accepts the plug of a microphone. When a microphone is plugged into this jack, the signal from the turntable is interrupted, i.e. record playing becomes impossible.

SELECTOR SWITCH

Chooses the program source.

AM AM reception.

FM MONO FM monophonic reception only.

FM AUTO FM reception with automatic switching for either stereo or monophonic programs.

PHONO/MIC For playing records or using a microphone.

AUX Program source plugged into the AUX jacks.

MODE SWITCH

STEREO: Stereo sound, left and right channels separated.

MONO: Left and right channels blended. Monophonic sound.

TAPE MONITOR SWITCH

This switch is set to ON (pushed) for monitoring a recording in progress and for playback of recorded tapes, when the tape deck is connected to the TAPE MON jacks and TAPE REC jacks or TAPE REC/P.B. socket.

LOUDNESS SWITCH

When listening at a low volume level, set this switch to ON (pushed). This emphasizes the extreme high and low ends of the sound spectrum, giving a more natural sound contour.

NOTE: If the front panel inscriptions of your unit become dirty, clean them with volatile fluid (chemical thinner, pure alcohol, etc.). In this case, the letters on the front panel may be blotted. Wipe out them with a soft dry cloth, however they will still remain unerased.

3. CONNECTION DIAGRAM

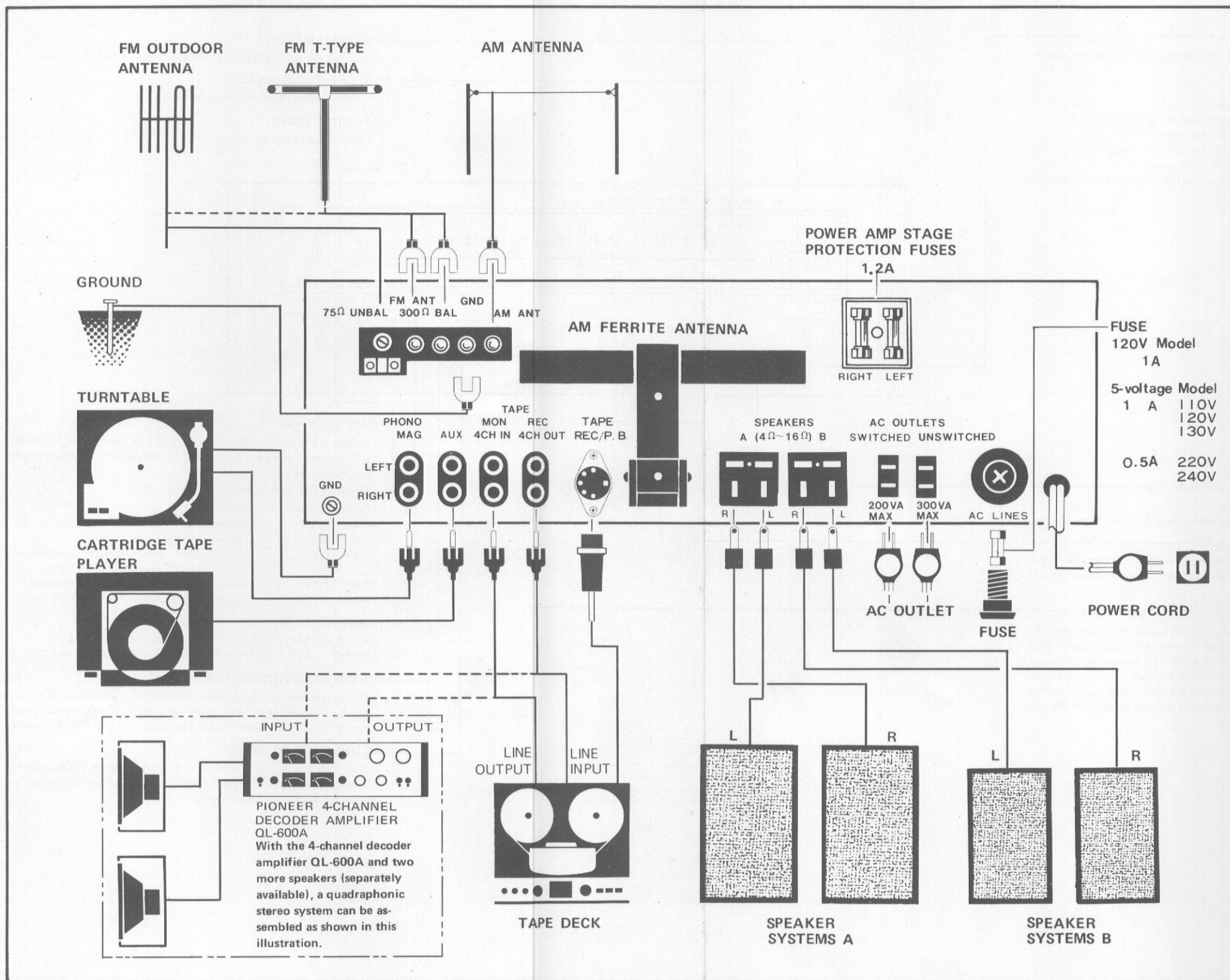

4. DISASSEMBLY

• Numbers indicate order of disassembly

1. Remove 4 screws from both sides of wooden case.
2. Pull off all knobs, then remove nuts and washers from shafts of SPEAKERS, TREBLE, and SELECTOR.
3. Remove 2 screws from top of front panel.
4. Remove 8 screws from bottom plate of receiver.

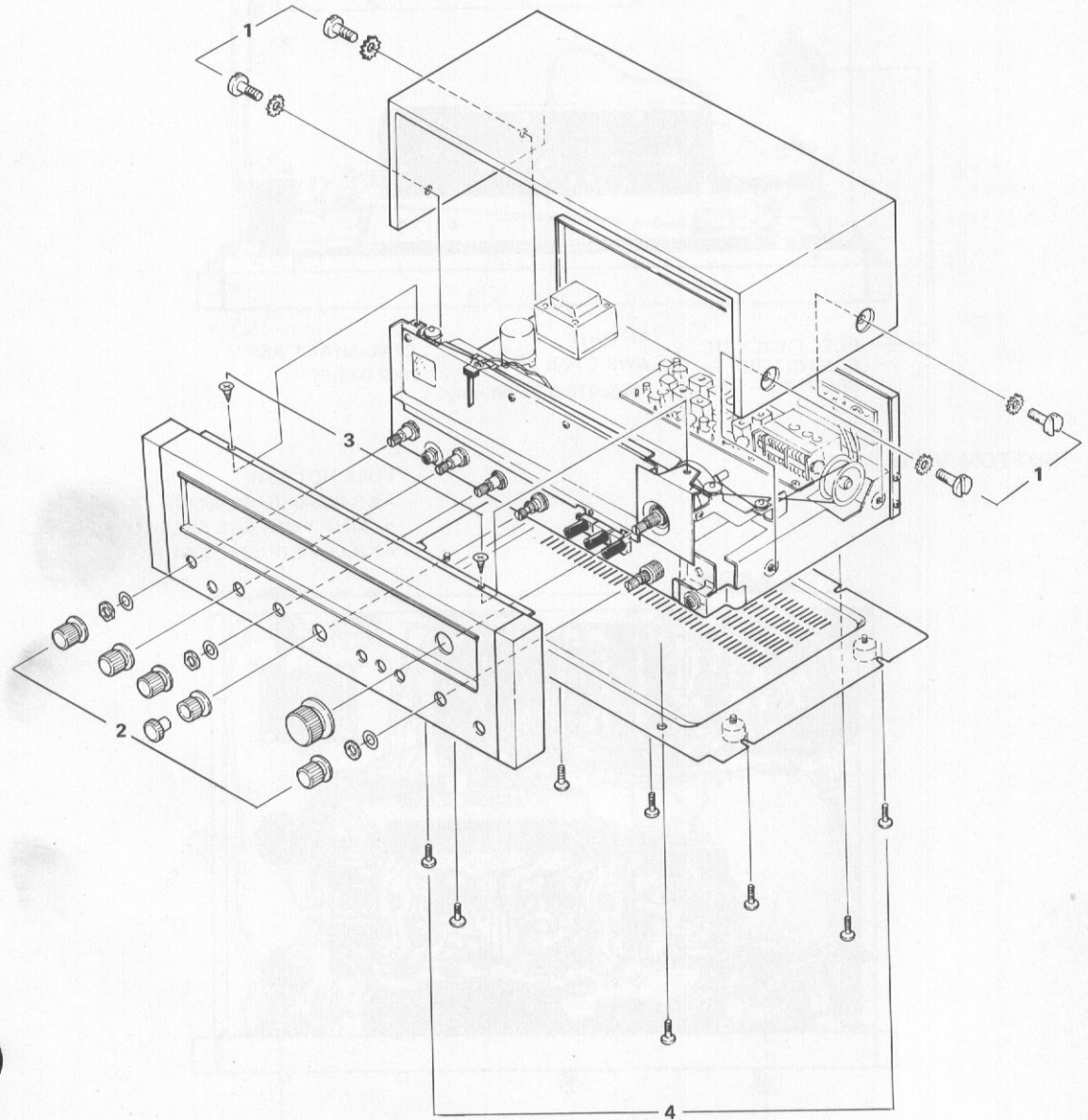

5. PARTS AND PCB LOCATION

TOP VIEW

POWER TRANSFORMER
 ATT-063-A (KUW)
 ATT-064-A (FVZW, FW)
 ATT-092-0 (KCW)
 ATT-093-0 (NBW)

TUNER UNIT
 AWE-008-A

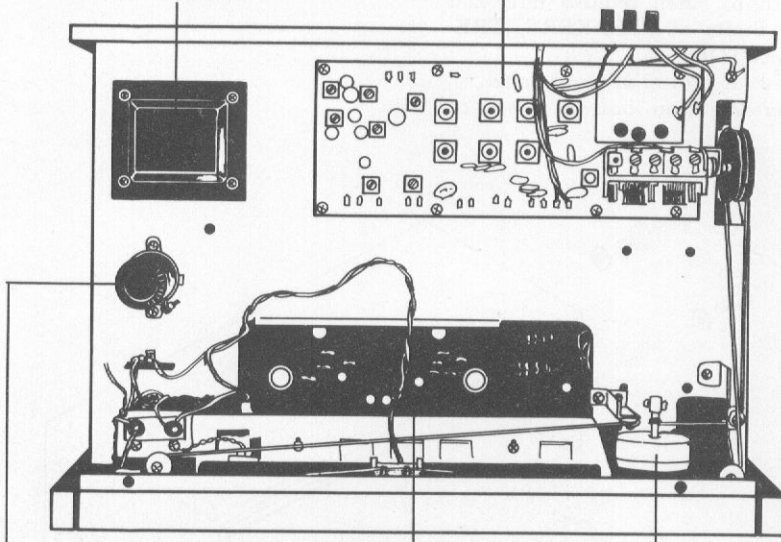

ELECTROLYTIC CAPACITOR
 C52-074-B

AF UNIT
 AWK-014-B
 AWK-018-0 (NBW only)

DIAL SHAFT ASS'Y
 M42-071-F

BOTTOM VIEW

FUSE HOLDER
 AKR-005-0 (KUW, KCW)
 or LINE VOLTAGE SELECTOR
 AKR-001-0 (FVZW, FW)

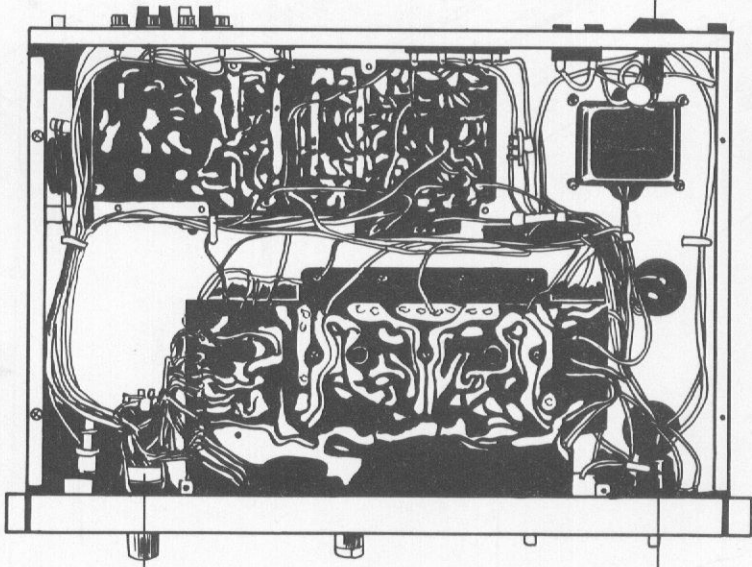

SELECTOR SWITCH
 ASC-021-0

OUTPUT SELECTOR
 ASA-025-0 (KUW, KCW)
 ASA-028-0 (FVZW, NBW, FW)

6. DIAL CORD STRINGING

1. Set the tuning capacitor to maximum capacitance.
2. Tie one end of the string to the spring on the tuning pulley.
3. Pull the string around the small pulley A.
4. Lead the string around the small pulleys B and C, then wind it 3 turns around the tuning shaft.
5. Wind the string 2 turns around the tuning pulley.
6. Finally, tie the end of the string to remaining side of spring on the tuning pulley.
7. Tune receiver to low end. Fasten dial pointer to string so that indicates low end on dial scale.

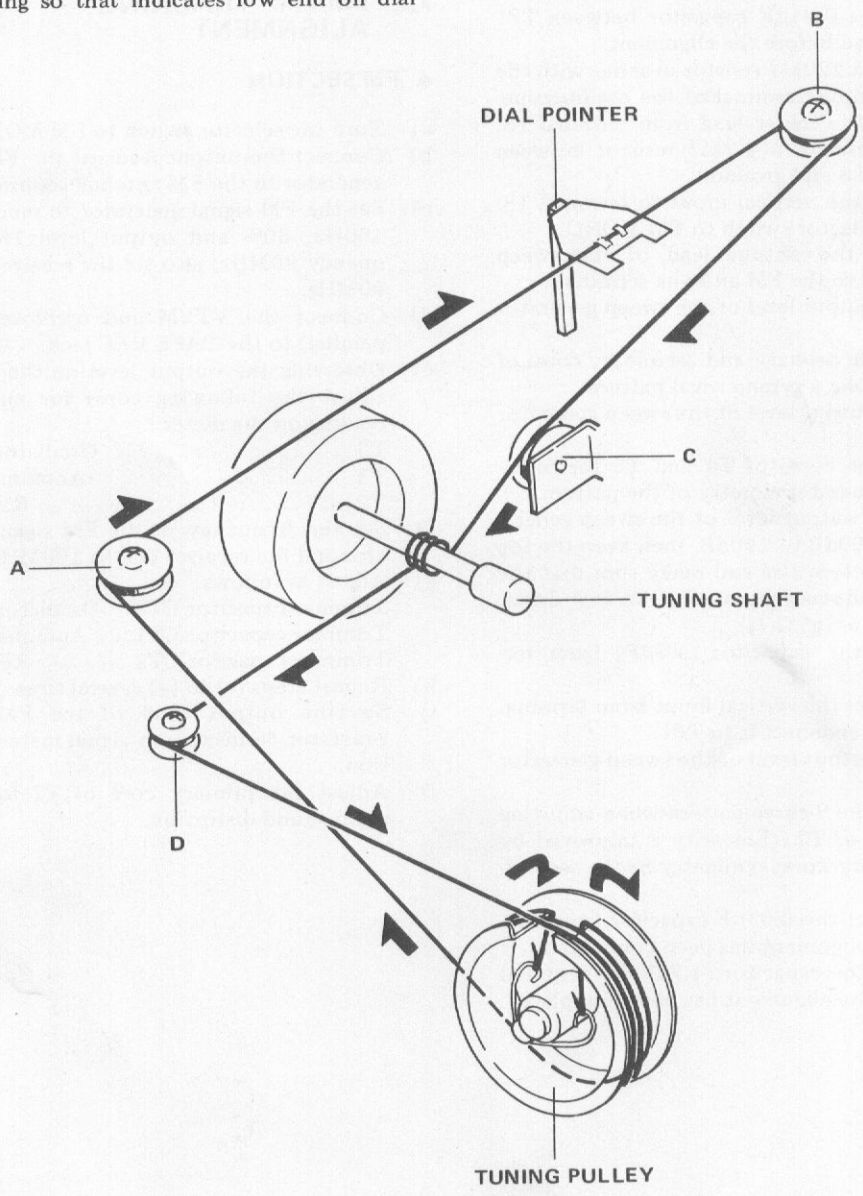

7. ALIGNMENT PROCEDURE

REQUIRED INSTRUMENTS

- FM/AM Signal generator
- FM/AM Sweep generator: Center frequency 10.7MHz, 455kHz
- Oscilloscope
- AC VTVM
- FM multiplex signal generator preferably with RF output

7.1 FM/AM IF ALIGNMENT

● FM SECTION

- a) Connect a $0.01\mu\text{F}$ capacitor between TP1 and ground before the alignment.
- b) Connect a $220\text{k}\Omega$ resistor in series with the vertical input terminal of the oscilloscope.
- c) Remove the meter lead from terminal 18, then terminate a $4.7\text{k}\Omega$ resistor between terminal 18 and ground.
- d) Connect the vertical input to terminal 18.
- e) Set the selector switch to FM MONO.
- f) Connect the output lead of the sweep generator to the FM antenna terminals.
- g) Set the output level of the sweep generator to 90dB.
- h) Adjust the primary and secondary cores of T6 to obtain a symmetrical pattern.
- i) Set the output level of the sweep generator to 70dB.
- j) Adjust the cores of T4 and T5 for maximum gain and symmetry of the pattern.
- k) Vary the output level of the sweep generator from 60dB to 100dB, then keep the top of the pattern flat and make sure that the center frequency does not drift. If it drifts, repeat steps (g) to (j).
- l) Remove the capacitor ($4.7\mu\text{F}$) from terminal 28.
- m) Disconnect the vertical input from terminal 18, then reconnect it to TP1.
- n) Set the output level of the sweep generator to 70dB.
- o) Observe the S-curve pattern when adjusting the cores of T7. (Linearity is improved by the primary core; symmetry by the secondary core.)
- p) Disconnect the $0.01\mu\text{F}$ capacitor from TP1 after the alignment has been completed.
- q) Connect the capacitor ($4.7\mu\text{F}$) to terminal 28 after the alignment has been completed.

● AM SECTION

- a) Turn the selector switch to AM.
- b) Connect the output lead of the sweep generator to the AM antenna terminal.
- c) Connect the vertical input of the oscilloscope to the TAPE REC jack.
- d) Set the output level of the sweep generator to 75dB.
- e) Adjust the IFT cores (T9, T10, T11) as shown in Fig. 1, for maximum gain and symmetrical pattern.

7.2 FM/AM TRACKING ALIGNMENT

● FM SECTION

- a) Turn the selector switch to FM MONO.
- b) Connect the output leads of the FM signal generator to the FM antenna terminals.
- c) Set the FM signal generator to modulation 400Hz, 30% and output level 15dB frequency 90MHz; also set the receiver dial to 90MHz.
- d) Connect the VTVM and oscilloscope (in parallel) to the TAPE REC jack.
- e) Observing the output level on the VTVM, adjust the following cores for maximum reading on the meter.
T3 Oscillator circuit
T1 Antenna circuit
T2 RF circuit
- f) Set the frequency of the FM signal generator and the receiver dial to 106MHz.
- g) Adjust as follows:
Trimmer capacitor CT3: Oscillator circuit
Trimmer capacitor CT1 .. Antenna circuit
Trimmer capacitor CT2 RF circuit
- h) Repeat steps (e) to (g) several times.
- i) Set the output level of the FM signal generator to maximum signal meter deflection.
- j) Adjust the primary core of T7 for minimum sound distortion.

● AM SECTION

- a) Turn the selector switch to AM.
- b) Connect the AM signal generator to the AM antenna terminal.
- c) Set the AM signal generator to modulation 400Hz, 30%, output level 30dB, frequency 600kHz. Set the receiver dial to 600kHz.
- d) Connect the VTVM and oscilloscope (in parallel) to the TAPE REC jack.
- e) Observing the output level on the VTVM, adjust the following cores for maximum reading.
 T8 Oscillator circuit
 Ferrite loopstick antenna: Antenna circuit
- f) Set the AM signal generator and the receiver dial to 1,400kHz.
- g) Observing the output level on the VTVM, adjust the following cores for maximum reading.
 CT5 Oscillator circuit
 CT4 Antenna circuit
- h) Repeat alignments (e) to (g) several times.
- i) After these alignments, lock the trimmer capacitor with paint.

7.3 MPX DECODER ALIGNMENT

- a) Modulate the FM signal generator output by FM MPX modulator.
- b) Turn the selector switch to FM AUTO.
- c) Connect the FM signal generator to the FM antenna terminals.
- d) Set the FM MPX modulator to modulation; main 1kHz (L+R) 60%, pilot 8 ~ 10%.
- e) Set the output level of the FM signal generator to 60dB.
- f) Turn the tuning knob to maximum reading on the signal meter.
- g) Set the modulation of the FM MPX modulator to pilot only.

- h) Connect the oscilloscope to TP2.
- i) Adjust the transformers (T13, T14, T15) until the output level of the 19kHz becomes maximum on the scope.
- j) Set the FM MPX modulator to pilot with L or R signal.
- k) Connect the dual-trace oscilloscope and VTVM to the TAPE REC jacks.
- l) Adjust the semi-fixed potentiometer on the tuner unit until the output level of the L or R signal becomes maximum on the scope.

7.4 OTHER ALIGNMENT

● CHECKING THE SCA FILTER

- a) Connect the FM signal generator to the FM antenna terminals.
- b) Modulate the FM signal generator connected to the audio generator, check that the frequency response shows troughs at around 67kHz and 72kHz.

● CHECKING THE STEREO INDICATOR

- a) Connect the FM signal generator to the FM antenna terminals.
- b) Turn the selector switch to FM AUTO.
- c) Modulate the FM signal generator connected to the FM MPX modulator, and set the FM MPX modulator pilot on. Check that the stereo indicator lamp goes in. Then set the FM MPX modulator to pilot off, and check that the stereo indicator lamp goes out.

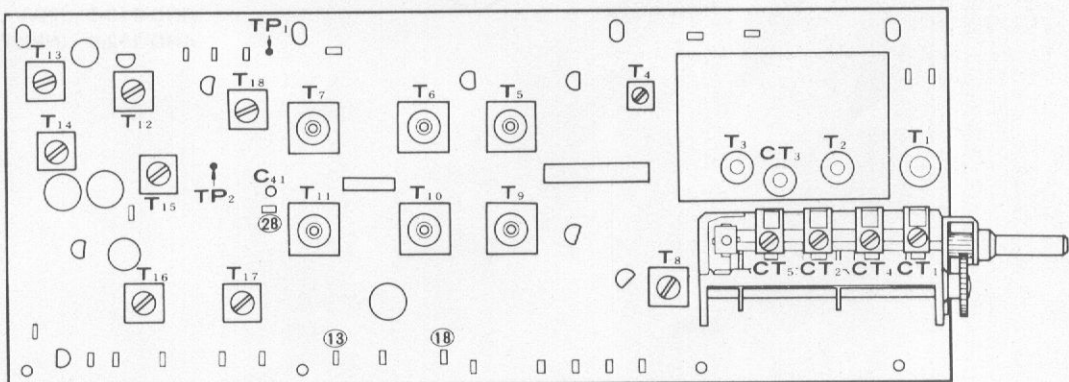

TUNER UNIT (AWE-008)

Fig. 1

8. PACKING METHOD AND PART NUMBERS

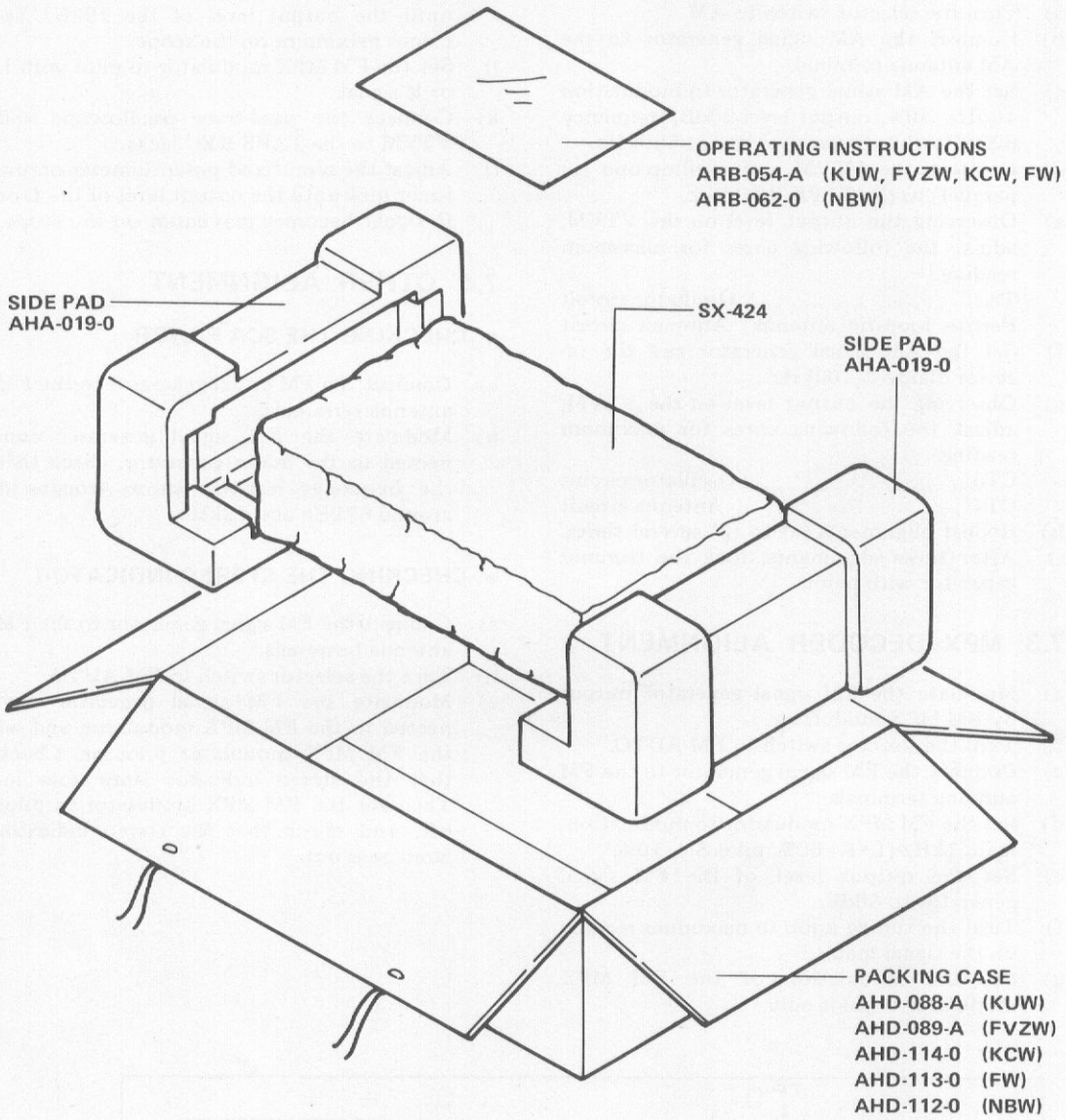

9. SCHEMATIC DIAGRAMS, PCB PATTERNS AND PARTS LIST

9.1 UNIT CONNECTION DIAGRAM AND MISCELLANEOUS PARTS

SX-424

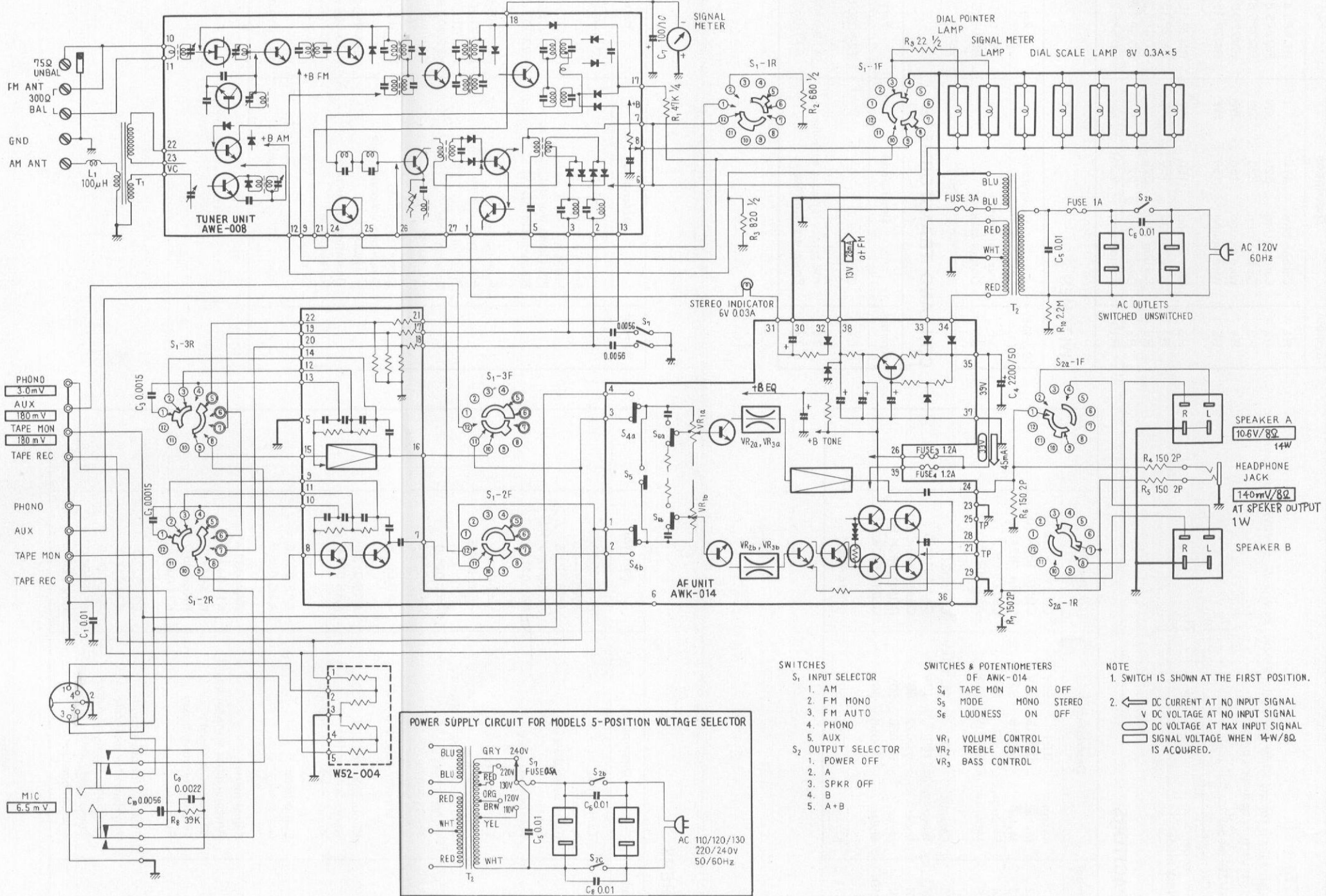

- SWITCHES**
- S₁ INPUT SELECTOR**
- 1. AM
 - 2. FM MONO
 - 3. FM AUTO
 - 4. PHONO
 - 5. AUX
- S₂ OUTPUT SELECTOR**
- 1. POWER OFF
 - 2. A
 - 3. SPKR OFF
 - 4. B
 - 5. A+B

- SWITCHES & POTENTIOMETERS OF AWK-014**
- S₄ TAPE MON ON OFF
 - S₅ MODE MONO STEREO
 - S₆ LOUDNESS ON OFF
- VR₁ VOLUME CONTROL
 VR₂ TREBLE CONTROL
 VR₃ BASS CONTROL

- NOTE**
- 1. SWITCH IS SHOWN AT THE FIRST POSITION.
 - 2. DC CURRENT AT NO INPUT SIGNAL
 DC VOLTAGE AT NO INPUT SIGNAL
 DC VOLTAGE AT MAX INPUT SIGNAL
 SIGNAL VOLTAGE WHEN 14-W/8Ω IS ACQUIRED.

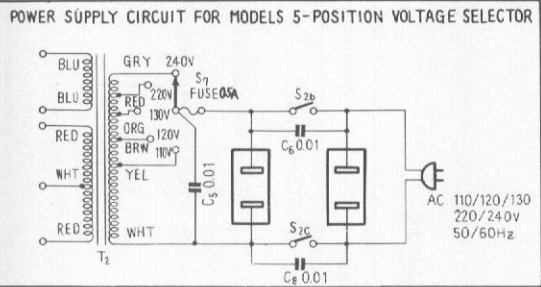

MISCELLANEOUS PARTS LIST

- CAPACITORS: IN μF UNLESS OTHERWISE NOTED. p: $\mu\mu\text{F}$.
- RESISTORS: IN Ω , $\frac{1}{4}\text{W}$ UNLESS OTHERWISE NOTED. k: $\text{k}\Omega$, M: $\text{M}\Omega$.

NOTE:

This parts list is for the KUW model, the FVZW, KCW, FW, or NBW model uses some different parts as following pages:

for FVZW model 17,
 for KCW model..... 19,
 for FW model 21,
 for NBW model 25.

CAPACITORS

Symbol	Description	Part No.
C1	Ceramic 0.01 50V	CKDYF 103Z 50
C2	Mylar 0.0015 50V	CQMA 152K 50
C3	Mylar 0.0015 50V	CQMA 152K 50
C4	Electrolytic 2200 50V	C52-074-B
C5	Metalized mylar 0.01 250V	ACE-002-0
C6	Ceramic 0.01 DC 1.4kV	C43-003-0
C7	Electrolytic 100 10V	CEA 101P 10
C8	Mylar 0.0022 50V	CQMA 222K 50
C9	Mylar 0.0056 50V	CQMA 562K 50
C10	Mylar 0.0056 50V	CQMA 562K 50
C11	Mylar 0.0056 50V	CQMA 562K 50

RESISTORS

Symbol	Description	Part No.
R1	Carbon film 47k	RD $\frac{1}{4}$ PS 473J
R2	Carbon film 820 $\frac{1}{4}\text{W}$	RD $\frac{1}{4}$ PS 821J
R3	Carbon film 820 $\frac{1}{4}\text{W}$	RD $\frac{1}{4}$ PS 821J
R4	Wire wound 150 2W	RM2P 151K
R5	Wire wound 150 2W	RM2P 151K
R6	Wire wound 150 2W	RM2P 151K
R7	Wire wound 150 2W	RM2P 151K
R8	Carbon film 39k	RD $\frac{1}{4}$ PS 393J
R9	Carbon film 22 $\frac{1}{2}\text{W}$	RD $\frac{1}{2}$ PS 220J
R10	Carbon film 2.2M $\frac{1}{2}\text{W}$	RD $\frac{1}{2}$ PS 225J

SWITCHES

Symbol	Description	Part No.
S1	Selector switch	ASC-021-0
S2	Output selector	ASA-025-0

COIL AND TRANSFORMERS

Symbol	Description	Part No.
L1	Choke coil	T24-030-0
T1	AM ferrite loopstic antenna	ATB-010-0
T2	Power transformer	ATT-063-A

Symbol	Description	Part No.	
	Tuner unit	AWE-008-A	
	AF unit	AWK-014-B	
	Front panel ass'y	ANB-127-B	
	Foot	AEC-012-0	
	Tuning shaft ass'y	M42-071-F	
	Tuning pulley	M42-080-A	
	Wooden case	AMM-014-B	
	AM ferrite loopstick antenna holder ass'y	AXB-001-0	
	Knob, tuning	AAA-004-B	
	Knob, selector, output selector bass, and treble	AAB-007-B	
	Knob, volume (L)	AAB-013-0	
	Knob, volume (R)	AAB-014-0	
	Knob, mode, tape monitor, and loudness	AAD-029-0	
	Dial pointer	AAF-007-B	
	Dial scale	AAG-035-0	
	Signal meter	AAW-003-A	
	Antenna input terminal board	K11-043-A	
	4P ground terminal	K13-047-0	
	4P input terminal board	AKB-005-0	
	Fuse 1A	E21-034-A	
	Fuse 3A for protection	E21-022-0	
	Pilot lamp for dial scale	E22-017-0	
	Pilot lamp for signal meter	AEL-006-0	
	Compound part for REC jack	W52-004-0	
	Microphone jack	K72-020-0	

Symbol	Description	Part No.	
	Headphones jack	K72-026-0	
	Speaker socket	K72-031-0	
	Spare AC outlet	AKP-002-0	
	Pilot lamp (for dial scale) socket	K91-005-A	
	5P connector (DIN)	K93-003-B	
	Fuse holder	AKR-005-0	
	FM T-type antenna	D52-013-0	
	Pin plug	K72-015-A	
	Speaker plug	K72-007-B	
	AC power cord	D11-003-E	
	Screw for ground	B11-012-A	
	Screw to fix wooden case (M4 x 15)	ABA-010-0	
	Operating instructions	ARB-054-A	
	Packing case	AHD-088-A	
	Side pad	AHA-019-0	
	Fuse 1.2A for protection	AEC-010-0	

For FVZW model

CAPACITORS

Symbol	Description			Part No.
C1	Ceramic	0.01	50V	CKDYF 103Z 50
C2	Mylar	0.0015	50V	CQMA 152K 50
C3	Mylar	0.0015	50V	CQMA 152K 50
C4	Electrolytic	2200	50V	C52-074-B
C5	Ceramic	0.01	DC 1.4kV	C43-003-0
C6	Ceramic	0.01	DC 1.4kV	C43-003-0
C7	Electrolytic	100	10V	CEA 101P 10
C8	Mylar	0.0022	50V	CQMA 222K 50
C9	Ceramic	0.01	DC 1.4kV	C43-003-0
C10	Mylar	0.0056	50V	CQMA 562K 50

RESISTORS

Symbol	Description			Part No.
R1	Carbon film	47k		RD½PS 473J
R2	Carbon film	820	½W	RD½PS 821J
R3	Carbon film	820	½W	RD½PS 821J
R4	Wire wound	150	2W	RM2P 151K
R5	Wire wound	150	2W	RM2P 151K
R6	Wire wound	150	2W	RM2P 151K
R7	Wire wound	150	2W	RM2P 151K
R8	Carbon film	39k		RD½PS 393J
R9	Carbon film	22	½W	RD½PS 220J

SWITCHES

Symbol	Description	Part No.
S1	Selector switch	ASC-021-0
S2	Output selector	ASA-028-0

COIL AND TRANSFORMERS

Symbol	Description	Part No.
L1	Choke coil	T24-030-0
T1	AM ferrite loopstick antenna	T42-022-B
T2	Power transformer	ATT-064-A

OTHERS

Symbol	Description	Part No.	
	Tuner unit	AWE-008-A	
	AF unit	AWK-014-B	
	Front panel ass'y	ANB-127-B	
	Foot	AEC-012-0	
	Tuning shaft ass'y	M42-071-F	
	Tuning pulley	M42-080-A	
	Wooden case	AMM-014-B	
	AM ferrite loopstick antenna holder ass'y	AXB-001-0	
	Knob, tuning	AAA-004-B	
	Knob, selector, output selector, bass, and treble	AAB-007-B	
	Knob, volume (L)	AAB-013-0	
	Knob, volume (R)	AAB-014-0	
	Knob, mode, tape monitor, and loudness	AAD-029-0	
	Dial pointer	AAF-007-B	
	Dial scale	AAG-035-0	
	Signal meter	AAW-003-A	
	Antenna input terminal board	K11-043-A	
	4P ground terminal	K13-047-0	
	4P input terminal board	AKB-005-0	
	Fuse 0.5A	E21-007-0	
	Fuse 3A for protection	E21-022-0	
	Pilot lamp for dial scale	E22-017-0	
	Pilot lamp for signal meter	AEL-006-0	
	Compound part for REC jack	W52-004-0	
	Microphone jack	K72-020-0	

Symbol	Description	Part No.	
	Headphones jack	K72-026-0	
	Speaker socket	K72-031-0	
	Spare AC outlet	K82-014-0	
	Pilot lamp (for dial scale) socket	K91-005-A	
	5P connector (DIN)	K93-003-B	
	Line voltage selector	AKR-001-0	
	FM T-type antenna	D52-013-0	
	Pin plug	K72-015-A	
	Speaker plug	K72-007-B	
	AC power cord	D11-002-B	
	Screw for ground	B11-012-A	
	Screw to fix wooden case (M4 x 15)	ABA-010-0	
	Operating instructions	ARB-054-A	
	Packing case	AHD-089-A	
	Side pad	AHA-019-0	
	Fuse 1A	E21-004-0	
	Fuse 1.2A for protection	AEC-010-0	

For KCW model

CAPACITORS

Symbol	Description			Part No.
C1	Ceramic	0.01	50V	CKDYF 103Z 50
C2	Mylar	0.0015	50V	CQMA 152K 50
C3	Mylar	0.0015	50V	CQMA 152K 50
C4	Electrolytic	2200	50V	C52-074-B
C5	Ceramic	0.01	DC1.4kV	C43-003-0
C6	Ceramic	0.01	DC1.4kV	C43-003-0
C7	Electrolytic	100	10V	CEA 101P 10
C8	Ceramic	0.01	DC1.4kV	C43-003-0
C9	Mylar	0.0022	50V	CQMA 222K 50
C10	Mylar	0.0056	50V	CQMA 562K 50
C11	Mylar	0.0056	50V	CQMA 562K 50
C12	Mylar	0.0056	50V	CQMA 562K 50
C13	Metalized mylar	0.01	250V	ACE-002-0

SWITCHES

Symbol	Description	Part No.
S1	Selector switch	ASC-021-0
S2	Output selector	ASA-025-0

COIL AND TRANSFORMERS

Symbol	Description	Part No.
L1	Choke coil	T24-030-0
T1	AM ferrite loopstick antenna	ATB-010-0
T2	Power transformer	ATT-092-0

RESISTORS

Symbol	Description			Part No.
R1	Carbon film	47k		RD $\frac{1}{4}$ PS 473J
R2	Carbon film	680	$\frac{1}{2}W$	RD $\frac{1}{2}$ PS 681J
R3	Carbon film	820	$\frac{1}{2}W$	RD $\frac{1}{2}$ PS 821J
R4	Wire wound	150	2W	RM2P 151K
R5	Wire wound	150	2W	RM2P 151K
R6	Wire wound	150	2W	RM2P 151K
R7	Wire wound	150	2W	RM2P 151K
R8	Carbon film	39k		RD $\frac{1}{4}$ PS 393J
R9	Carbon film	22	$\frac{1}{2}W$	RD $\frac{1}{2}$ PS 220J
R10	Carbon film	2.2M	$\frac{1}{2}W$	RD $\frac{1}{2}$ PS 225J

OTHERS

Symbol	Description	Part No.
	Tuner unit	AWE-008-A
	AF unit	AWK-014-B
	Front panel ass'y	ANB-127-B
	Foot	AEC-012-0
	Tuning shaft ass'y	M42-071-F
	Tuning pulley	M42-080-A
	Wooden case	AMM-014-B
	AM ferrite loopstick antenna holder ass'y	AXB-001-0
	Knob, tuning	AAA-004-B
	Knob, selector, bass, treble, and output selector	AAB-007-B
	Knob, volume (L)	AAB-013-0
	Knob, volume (R)	AAB-014-0
	Knob, mode, tape monitor, and loudness	AAD-029-0
	Dial scale	AAG-035-0
	Signal meter	AAW-003-A
	Dial pointer	AAF-007-B
	Antenna input terminal board	K11-043-A
	4P input terminal board	AKB-005-0
	4P ground terminal	K13-047-0
	Fuse 1A	E21-033-0
	Fuse 3A for protection	E21-022-0
	Pilot lamp for dial scale	E22-017-0
	Pilot lamp for signal meter	AEL-006-0
	Fuse 1.2A for protection	AEK-010-0
	Compound part for REC jack	W52-004-0

Symbol	Description	Part No.
	Microphone jack	K72-020-0
	Headphones jack	K72-026-0
	Speaker socket	K72-031-0
	Spare AC outlet	AKP-002-0
	Pilot lamp (for dial scale) socket	K91-005-A
	5P connector (DIN)	K93-003-B
	Fuse holder	AKR-005-0
	Fuse (for protection) holder	AKR-011-0
	Fuse cover	AEC-058-0
	AC power cord	D11-003-E
	Screw for ground	B11-012-A
	Screw to fix wooden case (M4 x 15)	ABA-010-0
	FM T-type antenna	D52-013-0
	Pin plug	K72-015-A
	Speaker plug	K72-007-B
	Fuse 1A for protection	E21-020-0
	Operating instructions	ARB-054-A
	Packing case	AHD-114-0
	Side pad	AHD-019-0

CAPACITORS

Symbol	Description			Part No.
C1	Ceramic	0.01	50V	CKDYF 103Z 50
C2	Mylar	0.0015	50V	CQMA 152K 50
C3	Mylar	0.0015	50V	CQMA 152K 50
C4	Electrolytic	2200	50V	C52-074-B
C5	Ceramic	0.01	DC1.4kV	C43-003-0
C6	Ceramic	0.01	DC1.4kV	C43-003-0
C7	Electrolytic	100	10V	CEA 101P 10
C8	Ceramic	0.01	DC1.4kV	C43-003-0
C9	Mylar	0.0022	50V	CQMA 222K 50
C10	Mylar	0.0056	50V	CQMA 562K 50
C11	Mylar	0.0056	50V	CQMA 562K 50
C12	Mylar	0.0056	50V	CQMA 562K 50

RESISTORS

Symbol	Description			Part No.
R1	Carbon film	47k		RD½PS 473J
R2	Carbon film	680	½W	RD½PS 681J
R3	Carbon film	820	½W	RD½PS 821J
R4	Wire wound	150	2W	RM2P 151K
R5	Wire wound	150	2W	RM2P 151K
R6	Wire wound	150	2W	RM2P 151K
R7	Wire wound	150	2W	RM2P 151K
R8	Carbon film	39k		RD½PS 393J
R9	Carbon film	22	½W	RD½PS 220J

SWITCHES

Symbol	Description	Part No.
S1	Selector switch	ASC-021-0
S2	Output selector	ASA-028-0
S7	De-emphasis selector	S41-022-A

COIL AND TRANSFORMERS

Symbol	Description	Part No.
L1	Choke coil	T24-030-0
T1	AM ferrite loopstick antenna	T42-022-B
T2	Power transformer	ATT-064-A

OTHERS

Symbol	Description	Part No.
	Tuner unit	AWE-008-A
	AF unit	AWK-014-B
	Front panel ass'y	ANB-127-B
	Foot	AEC-012-0
	Tuning shaft ass'y	M42-071-F
	Tuning pulley	M42-080-A
	Wooden case	AMM-014-B
	AM ferrite loopstick antenna holder ass'y	AXB-001-0
	Knob, tuning	AAA-004-B
	Knob, selector, bass, treble, and output selector	AAB-007-B
	Knob, volume (L)	AAB-013-0
	Knob, volume (R)	AAB-014-0
	Knob, mode, tape monitor, and loudness	AAD-029-0
	Dial scale	AAG-035-0
	Signal meter	AAW-003-A
	Dial pointer	AAF-007-B
	Antenna input terminal board	K11-043-A
	4P input terminal board	AKB-005-0
	4P ground terminal	K13-047-0
	Fuse 0.5A	E21-007-0
	Fuse 3A for protection	E21-022-0
	Pilot lamp for dial scale	E22-017-0
	Pilot lamp for signal meter	AEL-006-0
	Fuse 1.2A for protection	AEK-010-0
	Compound part for REC jack	W52-004-0

Symbol	Description	Part No.
	Microphone jack	K72-020-0
	Headphones jack	K72-026-0
	Speaker socket	K72-031-0
	Spare AC outlet	AKP-002-0
	Pilot lamp (for dial scale) socket	K91-005-A
	5P connector (DIN)	K93-003-B
	Line voltage selector	AKR-001-0
	Fuse (for protection) holder	AKR-011-0
	Fuse cover	AEC-058-0
	AC power cord	D11-002-B
	Screw for ground	B11-012-A
	Screw to fix wooden case (M4 x 15)	ABA-010-0
	FM T-type antenna	D52-013-0
	Pin plug	K72-015-A
	Speaker plug	K72-007-B
	Fuse 1A	E21-004-0
	Operating instructions	ARB-054-A
	Packing case	AHD-113-0
	Side pad	AHD-019-0

UNIT CONNECTION DIAGRAM FOR NBW MODEL

SX-424/NBW

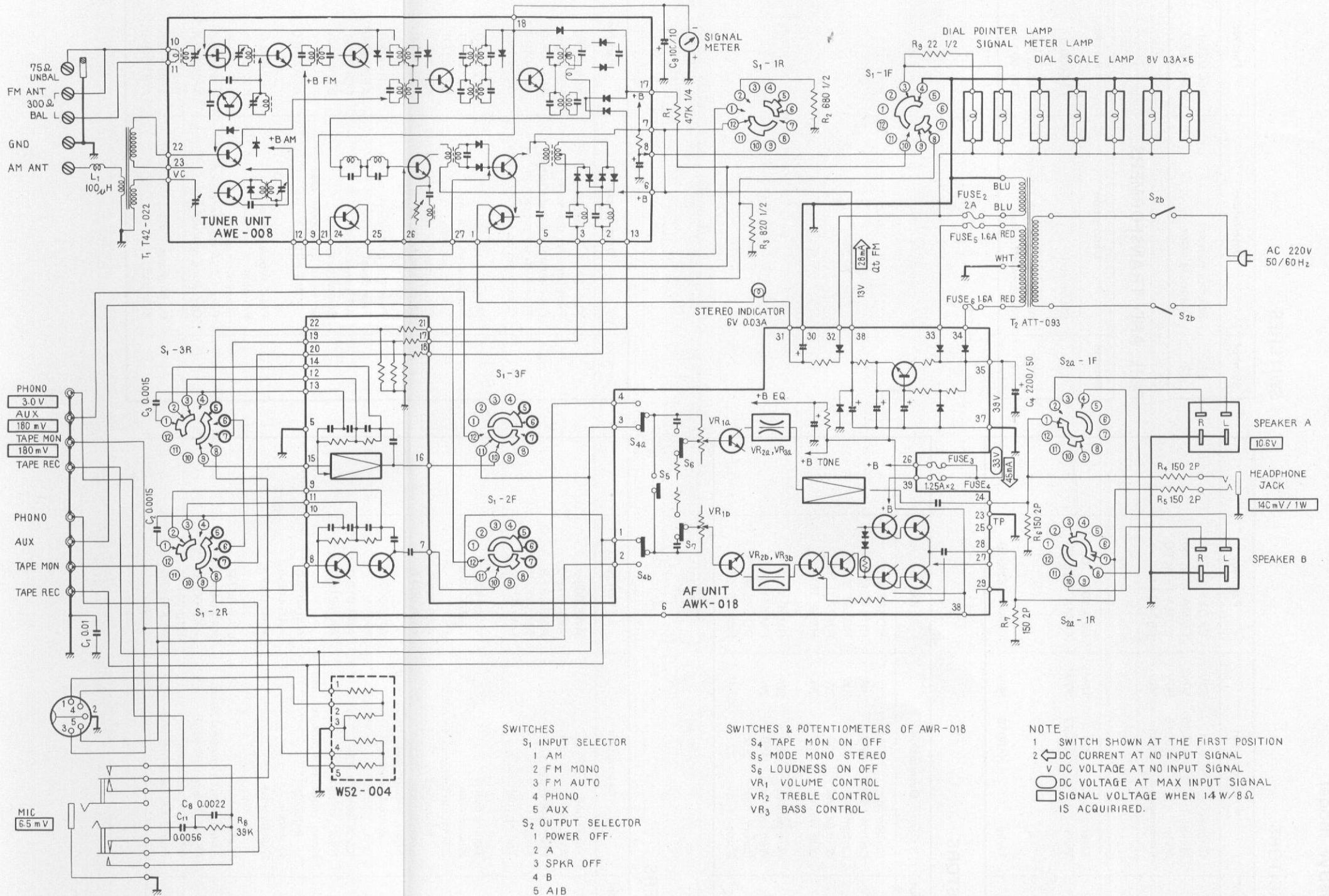

- SWITCHES
- S1 INPUT SELECTOR
- 1 AM
 - 2 FM MONO
 - 3 FM AUTO
 - 4 PHONO
 - 5 AUX
- S2 OUTPUT SELECTOR
- 1 POWER OFF
 - 2 A
 - 3 SPKR OFF
 - 4 B
 - 5 AIB

- SWITCHES & POTENTIOMETERS OF AWR-018
- S4 TAPE MON ON OFF
 - S5 MODE MONO STEREO
 - S6 LOUDNESS ON OFF
 - VR1 VOLUME CONTROL
 - VR2 TREBLE CONTROL
 - VR3 BASS CONTROL

NOTE

- 1 SWITCH SHOWN AT THE FIRST POSITION
- 2 ← DC CURRENT AT NO INPUT SIGNAL
- V DC VOLTAGE AT NO INPUT SIGNAL
- DC VOLTAGE AT MAX INPUT SIGNAL
- SIGNAL VOLTAGE WHEN 14 W/8 Ω IS ACQUIRED.

MISCELLANEOUS PARTS LIST

For NBW model

CAPACITORS

Symbol	Description			Part No.
C1	Ceramic	0.01	50V	CKDYF 103Z 50
C2	Mylar	0.0015	50V	CQMA 152K 50
C3	Mylar	0.0015	50V	CQMA 152K 50
C4	Electrolytic	2200	50V	C52-074-B
C5				
C6				
C7	Electrolytic	100	10V	CEA 101P 10
C8	Mylar	0.0022	50V	CQMA 222K 50
C9				
C10				
C11	Mylar	0.0056	50V	CQMA 562K 50

RESISTORS

Symbol	Description			Part No.
R1	Carbon film	47k		RD $\frac{1}{4}$ PS 473J
R2	Carbon film	680	$\frac{1}{2}$ W	RD $\frac{1}{2}$ PS 681J
R3	Carbon film	820	$\frac{1}{2}$ W	RD $\frac{1}{2}$ PS 821J
R4	Wire wound	150	2W	RM2P 151K
R5	Wire wound	150	2W	RM2P 151K
R6	Wire wound	150	2W	RM2P 151K
R7	Wire wound	150	2W	RM2P 151K
R8	Carbon film	39k		RD $\frac{1}{4}$ PS 393J
R9	Carbon film	22	$\frac{1}{2}$ W	RD $\frac{1}{4}$ PS 220J

SWITCHES

Symbol	Description	Part No.
S1	Selector switch	ASC-021-0
S2	Output selector	ASA-028-0

COIL AND TRANSFORMERS

Symbol	Description	Part No.
L1	Choke coil	T24-030-0
T1	AM ferrite loopstick antenna	T42-022-B
T2	Power transformer	ATT-093-0

OTHERS

Symbol	Description	Part No.	
	Tuner unit	AWE-008-A	
	AF unit	AWK-018-0	
	Front panel ass'y	ANB-127-B	
	Foot	AEC-012-0	
	Tuning shaft ass'y	M42-071-F	
	Tuning pulley	M42-080-A	
	Wooden case	AMM-014-B	
	AM ferrite loopstick antenna holder ass'y	AXB-001-0	
	Knob tuning	AAA-004-B	
	Knob, selector, bass, treble, and output selector	AAB-007-B	
	Knob, volume (L)	AAB-013-0	
	Knob, volume (R)	AAB-014-0	
	Knob, mode, tape monitor, and loudness	AAD-029-0	
	Dial scale	AAG-035-0	
	Signal meter	AAW-003-A	
	Dial pointer	AAF-007-B	
	Antenna input terminal board	K11-043-A	
	4P input terminal board	AKB-005-0	
	4P ground terminal	K13-047-0	
	Fuse 1.6A for protection	AEK-013-0	

Symbol	Description	Part No.	
	Fuse 2A for protection	AEK-017-0	
	Pilot lamp for dial scale	E22-017-0	
	Pilot lamp for signal meter	AEL-006-0	
	Fuse 1.2A for protection	AEK-010-0	
	Compound part for REC jack	W52-004-0	
	Microphone jack	K72-020-0	
	Headphones jack	K72-026-0	
	Speaker socket	K72-031-0	
	Pilot lamp (for dial scale) socket	K91-005-A	
	5P connector (DIN)	K93-003-B	
	Fuse (for protection) holder	K91-008-0	
	Fuse cover	AEC-058-0	
	AC power cord	D54-019-0	
	Screw for ground	B11-012-A	
	Screw to fix wooden case (M4 x 15)	ABA-010-0	
	FM T-type antenna	D52-013-0	
	Pin plug	K72-015-A	
	Speaker plug	K72-007-B	
	Fuse 1.25A for protection	AEK-018-0	
	Operating instructions	ARB-062-0	
	Parking case	AHD-112-0	
	Side pad	AHD-019-0	

AWE-008

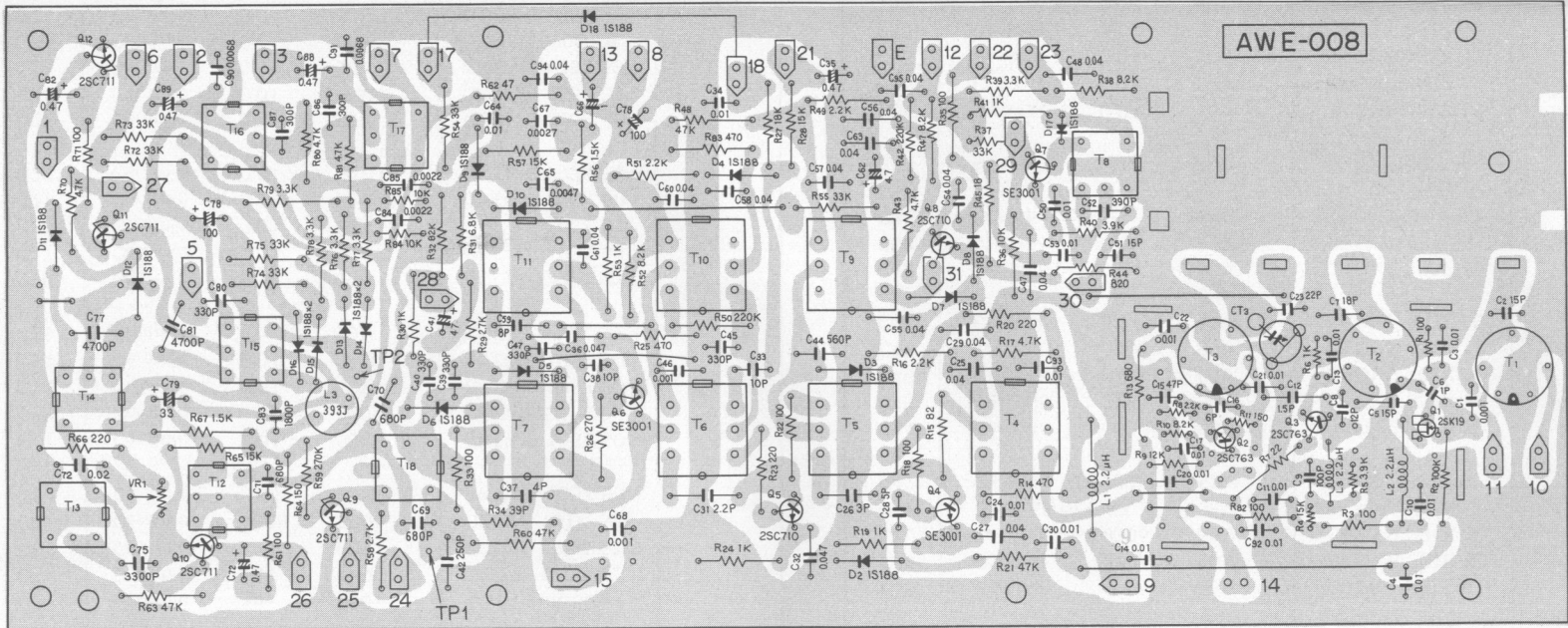

CAPACITORS

Symbol	Description	Part No.
VC	Tuning Capacitor	C64-046-A
CT3	Ceramic Trimmer	C43-007-A
C1	Ceramic 0.001 50V	CKDYF 102Z 50
C2	Ceramic 15p 50V	CCDSL 150K 50
C3	Ceramic 0.01 50V	CKDYF 103Z 50
C4	Ceramic 0.01 50V	CKDYF 103Z 50
C5	Ceramic 15p 50V	CCDSL 150K 50
C6	Ceramic 1p 500V	CGB 010K 500
C7	Ceramic 18p 50V	CCDSL 180K 50
C8	Ceramic 12p 50V	CCDSL 120K 50
C9	Ceramic 100p 50V	CCDSL 101K 50
C10	Ceramic 0.01 50V	CKDYF 103Z 50
C11	Ceramic 0.01 50V	CKDYF 103Z 50
C12	Ceramic 1.5p 500V	CGB 1R5K 500
C13	Ceramic 0.01 50V	CKDYF 103Z 50
C14	Ceramic 0.01 50V	CKDYF 103Z 50
C15	Ceramic 47p 50V	CCDSL 470K 50
C16	Ceramic 6p 50V	CCDUJ 060D 50
C17	Ceramic 0.01 50V	CKDYF 103Z 50
C20	Ceramic 0.01 50V	CKDYF 103Z 50
C21	Ceramic 0.01 50V	CKDYB 103K 50
C22	Ceramic 0.01 50V	CKDYB 103K 50
C23	Ceramic 22p 50V	CCDRH 220K 50
C24	Ceramic 0.01 50V	CKDYF 103Z 50
C25	Ceramic 0.04 50V	CKDYF 403Z 50
C26	Ceramic 3p 50V	CCDSL 030C 50
C27	Ceramic 0.04 50V	CKDYF 403Z 50

Symbol	Description	Part No.
C28	Ceramic 5p 50V	CCDSL 050D 50
C29	Ceramic 0.04 50V	CKDYF 403Z 50
C30	Ceramic 0.01 50V	CKDYF 103Z 50
C31	Ceramic 2.2p 500V	CGB 2R2K 500
C32	Ceramic 0.047 25V	CKDBC 473Z 25
C33	Ceramic 10p 50V	CCDSL 100F 50
C34	Ceramic 0.01 50V	CKDYF 103Z 50
C35	Electrolytic 0.47 50V	CEA R47P 50
C36	Ceramic 0.047 25V	CKDBC 473Z 25
C37	Ceramic 4p 50V	CCDSL 040D 50
C38	Ceramic 10p 50V	CCDSL 100F 50
C39	Ceramic 330p 50V	CKDYB 331K 50
C40	Ceramic 330p 50V	CKDYB 331K 50
C41	Electrolytic 4.7 25V	CEA 4R7P 25
C42	Ceramic 250p 50V	CCDSL 251K 50
C44	Ceramic 560p 50V	CKDYB 561K 50
C45	Ceramic 330p 50V	CKDYB 331K 50
C46	Ceramic 0.001 50V	CKDYB 102K 50
C47	Ceramic 330p 50V	CKDYB 331K 50
C48	Ceramic 0.04 50V	CKDYF 403Z 50
C49	Ceramic 0.04 50V	CKDYF 403Z 50
C50	Mylar 0.01 50V	CQMA 103K 50
C51	Ceramic 15p 50V	CCDUJ 150K 50
C52		
C53	Mylar 0.01 50V	CQMA 103K 50
C54	Ceramic 0.04 50V	CKDYF 403Z 50
C55	Ceramic 0.04 50V	CKDYF 403Z 50
C56	Ceramic 0.04 50V	CKDYF 403Z 50
C57	Ceramic 0.04 50V	CKDYF 403Z 50
C58	Ceramic 0.04 50V	CKDYF 403Z 50

Symbol	Description	Part No.
C59	Ceramic 8p 50V	CCDSL 080F 50
C60	Ceramic 0.04 50V	CKDYF 403Z 50
C61	Ceramic 0.04 50V	CKDYF 403Z 50
C62	Electrolytic 4.7 25V	CEA 4R7P 25
C63	Ceramic 0.04 50V	CKDYF 403Z 50
C64	Ceramic 0.01 50V	CKDYF 103Z 50
C65	Mylar 0.0047 50V	CQMA 472K 50
C66	Electrolytic 1 50V	CEA 010P 50
C67	Mylar 0.0027 50V	CQMA 272K 50
C68	Ceramic 0.001 50V	CKDYB 102K 50
C69		
C70	Styrol 680p 50V	CQSA 681J 50
C71		
C72	Electrolytic 0.47 50V	CEA R47P 50
C73	Electrolytic 100 16V	CEA 101P 16
C74	Mylar 0.02 50V	CQMA 203K 50
C75	Styrol 0.0033 50V	C15-011-A
C77	Styrol 0.0047 50V	C15-013-A
C78	Electrolytic 100 16V	CEA 101P 16
C79	Electrolytic 33 16V	CEA 330P 16
C80	Ceramic 330p 50V	CKDYB 331K 50
C81	Styrol 0.0047 50V	C15-013-A
C82	Electrolytic 0.47 50V	CEA R47P 50
C83	Styrol 0.0018 50V	CQSA 182J 50
C84	Mylar 0.0022 50V	CQMA 222K 50
C85	Mylar 0.0022 50V	CQMA 222K 50
C86	Styrol 300p 50V	CQSA 301J 50
C87	Styrol 300p 50V	CQSA 301J 50
C88	Electrolytic 0.47 50V	CEA R47P 50
C89	Electrolytic 0.47 50V	CEA R47P 50

Symbol	Description	Part No.
C90	Mylar 0.0068 50V	CQMA 682K 50
C91	Mylar 0.0068 50V	CQMA 682K 50
C92	Ceramic 0.01 50V	CKDYF 103Z 50
C93	Ceramic 0.01 50V	CKDYF 103Z 50
C94	Ceramic 0.04 50V	CKDYF 403Z 50
C95	Ceramic 0.04 50V	CKDYF 403Z 50

RESISTORS

Symbol	Description	Part No.
VR1	Semi-fixed 330-B	C92-065-A
R1	Carbon film 100	RD $\frac{1}{2}$ VS 101J
R2	Carbon film 100k	RD $\frac{1}{2}$ PS 104J
R3	Carbon film 100	RD $\frac{1}{2}$ VS 101J
R4	Carbon film 15k	RD $\frac{1}{2}$ VS 153J
R5	Carbon film 3.9k	RD $\frac{1}{2}$ VS 392J
R6	Carbon film 1k	RD $\frac{1}{2}$ VS 102J
R7	Carbon film 22	RD $\frac{1}{2}$ PS 220J
R8	Carbon film 2.2k	RD $\frac{1}{2}$ VS 222J
R9	Carbon film 12k	RD $\frac{1}{2}$ VS 123J
R10	Carbon film 8.2k	RD $\frac{1}{2}$ VS 822J
R11	Carbon film 150	RD $\frac{1}{2}$ VS 151J
R13	Carbon film 680	RD $\frac{1}{2}$ PS 681J
R14	Carbon film 470	RD $\frac{1}{2}$ PS 471J
R15	Carbon film 82	RD $\frac{1}{2}$ PS 820J
R16	Carbon film 2.2k	RD $\frac{1}{2}$ PS 222J
R17	Carbon film 4.7k	RD $\frac{1}{2}$ PS 472J
R18	Carbon film 100	RD $\frac{1}{2}$ PS 101J
R19	Carbon film 1k	RD $\frac{1}{2}$ PS 102J
R20	Carbon film 220	RD $\frac{1}{2}$ PS 221J
R21	Carbon film 47k	RD $\frac{1}{2}$ PS 473J

Symbol	Description	Part No.
R22	Carbon film 100	RD¼PS 101J
R23	Carbon film 220	RD¼PS 221J
R24	Carbon film 1k	RD¼PS 102J
R25	Carbon film 470	RD¼PS 471J
R26	Carbon film 270	RD¼PS 271J
R27	Carbon film 18k	RD¼PS 183J
R28	Carbon film 15k	RD¼PS 153J
R29	Carbon film 2.7k	RD¼PS 272J
R30	Carbon film 1k	RD¼PS 102J
R31	Carbon film 6.8k	RD¼PS 682J
R32	Carbon film 8.2k	RD¼PS 822J
R33	Carbon film 100	RD¼PS 101J
R34	Carbon film 39k	RD¼PS 393J
R35	Carbon film 100	RD¼PS 101J
R36	Carbon film 10k	RD¼PS 103J
R37	Carbon film 33k	RD¼VS 333J
R38	Carbon film 8.2k	RD¼PS 822J
R39	Carbon film 3.3k	RD¼PS 332J
R40	Carbon film 3.9k	RD¼PS 392J
R41	Carbon film 1k	RD¼PS 102J
R42	Carbon film 220k	RD¼PS 224J
R43	Carbon film 4.7k	RD¼PS 472J
R44	Carbon film 820	RD¼PS 821J
R45	Carbon film 18	RD¼PS 180J
R47	Carbon film 8.2k	RD¼PS 822J
R48	Carbon film 4.7k	RD¼PS 472J
R49	Carbon film 2.2k	RD¼PS 222J
R50	Carbon film 220k	RD¼PS 224J
R51	Carbon film 2.2k	RD¼PS 222J
R52	Carbon film 8.2k	RD¼PS 822J

Symbol	Description	Part No.
R53	Carbon film 1k	RD¼PS 102J
R54	Carbon film 3.3k	RD¼PS 332J
R55	Carbon film 33k	RD¼PS 333J
R56	Carbon film 1.5k	RD¼PS 152J
R57	Carbon film 15k	RD¼PS 153J
R58	Carbon film 2.7k	RD¼PS 272J
R59	Carbon film 270k	RD¼PS 274J
R60	Carbon film 47k	RD¼PS 473J
R61	Carbon film 100	RD¼PS 101J
R62	Carbon film 47	RD¼PS 470J
R63	Carbon film 47k	RD¼PS 473J
R64	Carbon film 150k	RD¼PS 154J
R65	Carbon film 15k	RD¼PS 153J
R66	Carbon film 220	RD¼PS 221J
R67	Carbon film 1.5k	RD¼PS 152J
R70	Carbon film 4.7k	RD¼PS 472J
R71	Carbon film 100	RD¼PS 101J
R72	Carbon film 33k	RD¼PS 333J
R73	Carbon film 33k	RD¼PS 333J
R74	Carbon film 33k	RD¼PS 333J
R75	Carbon film 33k	RD¼PS 333J
R76	Carbon film 3.3k	RD¼PS 332J
R77	Carbon film 3.3k	RD¼PS 332J
R78	Carbon film 3.3k	RD¼PS 332J
R79	Carbon film 3.3k	RD¼PS 332J
R80	Carbon film 4.7k	RD¼PS 472J
R81	Carbon film 4.7k	RD¼PS 472J
R82	Carbon film 100	RD¼VS 101J
R83	Carbon film 470	RD¼PS 471J
R84	Carbon film 10k	RD¼VS 103J
R85	Carbon film 10k	RD¼VS 103J

SEMICONDUCTORS

Symbol	Description	Part No.
Q1	2SK19-Y FET	
Q2	2SC763-D or C Transistor	
Q3	2SC763-D or C Transistor	
Q4	SE3001 or 2SC738 Transistor	
Q5	2SC710R-D or C Transistor	
Q6	SE3001 or 2SC738 Transistor	
Q7	SE3001 or 2SC738 Transistor	
Q8	2SC710-D or R-D Transistor	
Q9	2SC711-F Transistor	
Q10	2SC711-E or F Transistor	
Q11	2SC711-E or F Transistor	
Q12	2SC711-F Transistor	
D2	1S188 FM-1 Diode	
D3	1S188 FM-1 Diode	
D4	1S188 FM-1 Diode	
D5	1S188 FM-1 Diode	
D6	1S188 FM-1 Diode	
D7	1S188 FM-1 Diode	
D8	1S188 FM-1 Diode	
D9	1S188 FM-1 Diode	
D10	1S188 FM-1 Diode	
D11	1S188 FM-1 Diode	
D12	1S188 FM-1 Diode	
D13	1S188 FM-1 Diode	
D14	1S188 FM-1 Diode	
D15	1S188 FM-1 Diode	
D16	1S188 FM-1 Diode	
D17	1S188 FM-1 Diode	
D18	1S188 FM-1 Diode	

COILS AND TRANSFORMERS

Symbol	Description	Part No.
T1	FM Antenna Coil	ATC-002-0
T2	FM RF Coil	ATC-004-0
T3	FM OSC Coil	ATC-003-0
T4	FM IF Transformer	T73-034-0
T5	FM IF Transformer	T73-035-A
T6	FM IF Transformer	T73-036-0
T7	FM IF Transformer	T74-011-0
T8	AM OSC Coil	ATB-001-A
T9	AM IF Transformer	T71-028-0
T10	AM IF Transformer	T71-028-0
T11	AM IF Transformer	T72-022-0
T12	SCA Coil	ATM-006-0
T13	19kHz Transformer	T75-023-0
T14	19kHz Transformer	T75-024-0
T15	38kHz Transformer	T75-025-0
T16	38kHz Filter Coil	ATM-004-0
T17	38kHz Filter Coil	ATM-004-0
T18	SCA Coil	ATM-007-0
L1	RF Choke Coil	T24-028-A
L2	RF Choke Coil	T24-028-A
L3	RF Choke Coil	T24-028-A
L5	Choke Coil	T75-006-B

9.3 AF UNIT (AWK-014) (AWK-018)

NOTE:

All items including CIRCUIT DIAGRAM, PCB PATTERNS, and PARTS LIST of the AF unit in this manual for NBW model can also be commonly used for other models, except when new parts for replacement are attached to the PCB of NBW model.

To protect NBW model from over-heating, it is factory-adjusted to take a slight clearance between the PCB and parts, meeting the requirements of the Scandinavian Safety Standards.
When replacing parts, do not fail to take such a slight clearance.

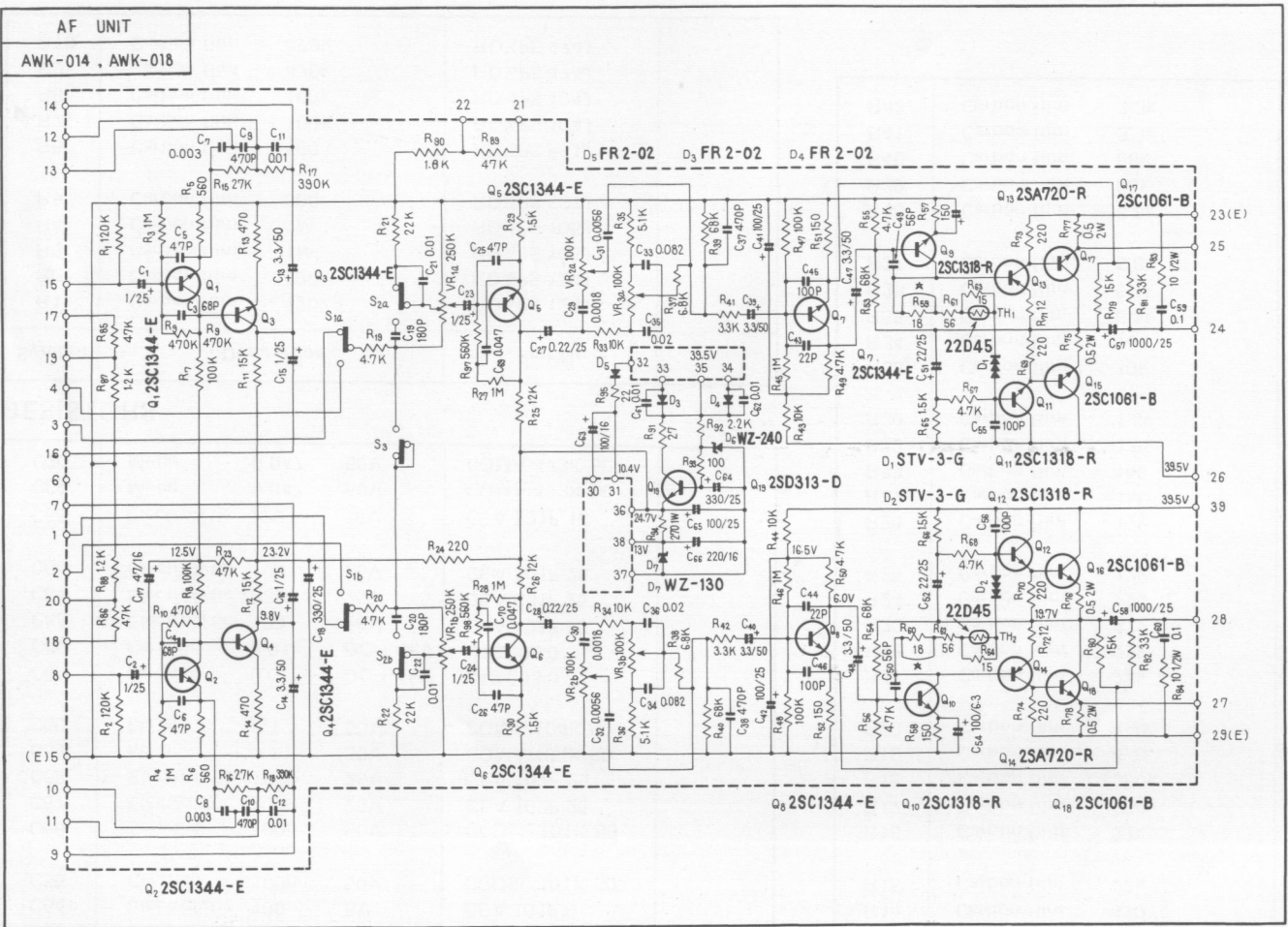

AWK-014

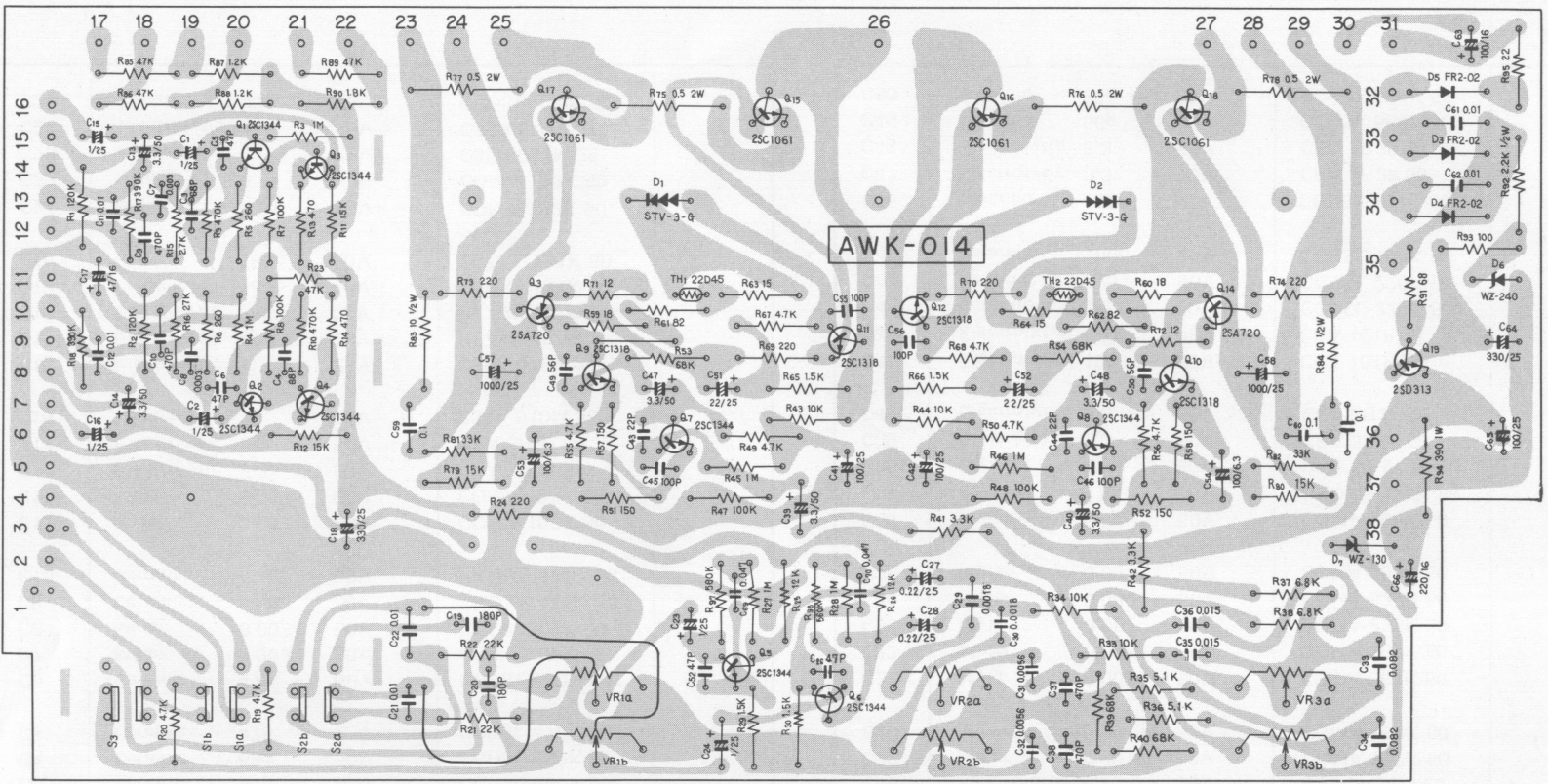

PRATS LIST OF AF UNIT

CAPACITORS

Symbol	Description			Part No.
C1	Electrolytic	1	25V	CSSA 010M 25
C2	Electrolytic	1	25V	CSSA 010M 25
C3	Ceramic	68p	50V	CCDSL 680K 50
C4	Ceramic	68p	50V	CCDSL 680K 50
C5	Ceramic	47p	50V	CCDSL 470K 50
C6	Ceramic	47p	50V	CCDSL 470K 50
C7	Mylar	0.003	50V	CQMA 302K 50
C8	Mylar	0.003	50V	CQMA 302K 50
C9	Ceramic	470p	50V	CKDYB 471K 50
C10	Ceramic	470p	50V	CKDYB 471K 50
C11	Mylar	0.01	50V	CQMA 103K 50
C12	Mylar	0.01	50V	CQMA 103K 50
C13	Electrolytic	3.3	50V	CEA 3R3P 50
C14	Electrolytic	3.3	50V	CEA 3R3P 50
C15	Electrolytic	1	25V	CSSA 010M 25
C16	Electrolytic	1	25V	CSSA 010M 25
C17	Electrolytic	47	16V	CEA 470P 16
C18	Electrolytic	330	25V	CEA 331P 25
C19	Ceramic	180p	50V	CCDSL 181K 50
C20	Ceramic	180p	50V	CCDSL 181K 50
C21	Mylar	0.01	50V	CQMA 103K 50
C22	Mylar	0.01	50V	CQMA 103K 50
C23	Electrolytic	1	25V	CSSA 010M 25
C24	Electrolytic	1	25V	CSSA 010M 25
C25	Ceramic	47p	50V	CCDSL 470K 50

Symbol	Description			Part No.
C26	Ceramic	47p	50V	CCDSL 470K 50
C27	Electrolytic	0.22	25V	CSSA R22M 25
C28	Electrolytic	0.22	25V	CSSA R22M 25
C29	Mylar	0.0018	50V	CQMA 182K 50
C30	Mylar	0.0018	50V	CQMA 182K 50
C31	Mylar	0.0056	50V	CQMA 562K 50
C32	Mylar	0.0056	50V	CQMA 562K 50
C33	Mylar	0.082	50V	CQMA 823K 50
C34	Mylar	0.082	50V	CQMA 823K 50
C35	Mylar	0.02	50V	CQMA 203K 50
C36	Mylar	0.02	50V	CQMA 203K 50
C37	Ceramic	470p	50V	CKDYB 471K 50
C38	Ceramic	470p	50V	CKDYB 471K 50
C39	Electrolytic	3.3	50V	CEA 3R3P 50
C40	Electrolytic	3.3	50V	CEA 3R3P 50
C41	Electrolytic	100	25V	CEA 101P 25
C42	Electrolytic	100	25V	CEA 101P 25
C43	Ceramic	22p	50V	CCDSL 220K 50
C44	Ceramic	22p	50V	CCDSL 220K 50
C45	Ceramic	100p	50V	CCDSL 101K 50
C46	Ceramic	100p	50V	CCDSL 101K 50
C47	Electrolytic	3.3	50V	CEA 3R3P 50
C48	Electrolytic	3.3	50V	CEA 3R3P 50
C49	Ceramic	56p	50V	CCDSL 560K 50
C50	Ceramic	56p	50V	CCDSL 560K 50

Symbol	Description			Part No.
C51	Electrolytic	22	25V	CEA 220P 25
C52	Electrolytic	22	25V	CEA 220P 25
C53	Electrolytic	100	6V	CEA 101P 6
C54	Electrolytic	100	6V	CEA 101P 6
C55	Ceramic	100p	50V	CCDSL 101K 50
C56	Ceramic	100p	50V	CCDSL 101K 50
C57	Electrolytic	1000	25V	CEA 102P 25
C58	Electrolytic	1000	25V	CEA 102P 25
C59	Mylar	0.1	50V	CQMA 104K 50
C60	Mylar	0.1	50V	CQMA 104K 50
C61	Ceramic	0.01	DC 1.4kV	C43-003-0
C62	Ceramic	0.01	DC 1.4kV	C43-003-0
C63	Electrolytic	100	16V	CEA 101P 16
C64	Electrolytic	330	25V	CEA 331P 25
C65	Electrolytic	100	25V	CEA 101P 25
C66	Electrolytic	220	16V	CEA 221P 16
C69	Mylar	0.047	50V	CQMA 473K 50
C70	Mylar	0.047	50V	CQMA 473K 50

RESISTORS

Symbol	Description			Part No.
R1	Carbon film	120k		RD%PS 124J
R2	Carbon film	120k		RD%PS 124J
R3	Carbon film	1M		RD%PS 105J
R4	Carbon film	1M		RD%PS 105J
R5	Carbon film	560		RD%PS 561J
R6	Carbon film	560		RD%PS 561J
R7	Carbon film	100k		RD%PS 104J
R8	Carbon film	100k		RD%PS 104J
R9	Carbon film	470k		RD%PS 474J
R10	Carbon film	470k		RD%PS 474J

Symbol	Description		Part No.
R11	Carbon film	15k	RD%PS 153J
R12	Carbon film	15k	RD%PS 153J
R13	Carbon film	470	RD%PS 471J
R14	Carbon film	470	RD%PS 471J
R15	Carbon film	27k	RD%PS 273J
R16	Carbon film	27k	RD%PS 273J
R17	Carbon film	390k	RD%PS 394J
R18	Carbon film	390k	RD%PS 394J
R19	Carbon film	4.7k	RD%PS 472J
R20	Carbon film	4.7k	RD%PS 472J
R21	Carbon film	22k	RD%PS 223J
R22	Carbon film	22k	RD%PS 223J
R23	Carbon film	47k	RD%PS 473J
R24	Carbon film	220	RD%PS 221J
R25	Carbon film	12k	RD%PS 123J
R26	Carbon film	12k	RD%PS 123J
R27	Carbon film	1M	RD%PS 105J
R28	Carbon film	1M	RD%PS 105J
R29	Carbon film	1.5k	RD%PS 152J
R30	Carbon film	1.5k	RD%PS 152J
R33	Carbon film	10k	RD%PS 103J
R34	Carbon film	10k	RD%PS 103J
R35	Carbon film	5.1k	RD%PS 512J
R36	Carbon film	5.1k	RD%PS 512J
R37	Carbon film	6.8k	RD%PS 682J
R38	Carbon film	6.8k	RD%PS 682J
R39	Carbon film	68k	RD%PS 683J
R40	Carbon film	68k	RD%PS 683J
R41	Carbon film	3.3k	RD%PS 332J
R42	Carbon film	3.3k	RD%PS 332J

Symbol	Description	Part No.
R43	Carbon film 10k	RD¼PS 103J
R44	Carbon film 10k	RD¼PS 103J
R45	Carbon film 1M	RD¼PS 105J
R46	Carbon film 1M	RD¼PS 105J
R47	Carbon film 100k	RD¼PS 104J
R48	Carbon film 100k	RD¼PS 104J
R49	Carbon film 4.7k	RD¼PS 472J
R50	Carbon film 4.7k	RD¼PS 472J
R51	Carbon film 150	RD¼PS 151J
R52	Carbon film 150	RD¼PS 151J
R53	Carbon film 68k	RD¼PS 683J
R54	Carbon film 68k	RD¼PS 683J
R55	Carbon film 4.7k	RD¼PS 472J
R56	Carbon film 4.7k	RD¼PS 472J
R57	Carbon film 150	RD¼PS 151J
R58	Carbon film 150	RD¼PS 151J
R59	Carbon film 18	RD¼PS 180J
R60	Carbon film 18	RD¼PS 180J
R61	Carbon film 56	RD¼PS 560J
R62	Carbon film 56	RD¼PS 560J
R63	Carbon film 15	RD¼PS 150J
R64	Carbon film 15	RD¼PS 150J
R65	Carbon film 1.5k	RD¼PS 152J
R66	Carbon film 1.5k	RD¼PS 152J
R67	Carbon film 4.7k	RD¼PS 472J
R68	Carbon film 4.7k	RD¼PS 472J
R69	Carbon film 220	RD¼PS 221J
R70	Carbon film 220	RD¼PS 221J
R71	Carbon film 12	RD¼PS 120J
R72	Carbon film 12	RD¼PS 120J

Symbol	Description	Part No.
R73	Carbon film 220	RD¼PS 221J
R74	Carbon film 220	RD¼PS 221J
R75	Metal oxide 0.5 2W	RN2H 0R5K
R76	Metal oxide 0.5 2W	RN2H 0R5K
R77	Metal oxide 0.5 2W	RN2H 0R5K
R78	Metal oxide 0.5 2W	RN2H 0R5K
R79	Carbon film 15k	RD¼PS 153J
R80	Carbon film 15k	RD¼PS 153J
R81	Carbon film 33k	RD¼PS 333J
R82	Carbon film 33k	RD¼PS 333J
R83	Carbon film 10 ¼W	RD¼PS 100J
R84	Carbon film 10 ¼W	RD¼PS 100J
R85	Carbon film 47k	RD¼PS 473J
R86	Carbon film 47k	RD¼PS 473J
R87	Carbon film 1.2k	RD¼PS 122J
R88	Carbon film 1.2k	RD¼PS 122J
R89	Carbon film 47k	RD¼PS 473J
R90	Carbon film 1.8k	RD¼PS 182J
R91	Carbon film 27	RD¼PS 270J
R92	Carbon film 2.2k ¼W	RD¼PS 222J
R93	Carbon film 100	RD¼PS 101J
R94	Metal oxide 270 1W	RS1P 271J
R95	Carbon film 22	RD¼PS 220J
R97	Carbon film 560k	RD¼PS 564J
R98	Carbon film 560k	RD¼PS 564J
VR1	250k dual, Volume	C87-025-0
VR2	100k dual, Treble	C82-046-A
VR3	100k dual, Bass	C82-046-A

SEMICONDUCTORS

Symbol	Description	Part No.
Q1	2SC1344-E or D Transistor	
Q2	2SC1344-E or D Transistor	
Q3	2SC1344-E or D Transistor	
Q4	2SC1344-E or D Transistor	
Q5	2SC1344-E or D Transistor	
Q6	2SC1344-E or D Transistor	
Q7	2SC1344-E or D Transistor	
Q8	2SC1344-E or D Transistor	
Q9	2SC1318-R or Q Transistor	
Q10	2SC1318-R or Q Transistor	
Q11	2SC1318-R or Q Transistor	
Q12	2SC1318-R or Q Transistor	
Q13	2SA720-R or Q Transistor	
Q14	2SA720-R or Q Transistor	
Q15	2SC1061-B or C Transistor	
Q16	2SC1061-B or C Transistor	
Q17	2SC1061-B or C Transistor	
Q18	2SC1061-B or C Transistor	
Q19	2SD313-D or E Transistor	
D1	STV-3-G Varistor	
D2	STV-3-G Varistor	
D3	FR2-02 Diode	
D4	FR2-02 Diode	
D5	FR2-02 Diode	
D6	WZ-240 Zener diode	
D7	WZ-130 Zener diode	
TH1	22D45 Thermistor	
TH2	22D45 Thermistor	

SWITCHES

Symbol	Description	Part No.
S1	Push switch	ASG-017-0
S2	Push switch	ASG-017-0
S3	Push switch	ASG-017-0

OTHERS

Symbol	Description	Part No.
	Insulating bushing	AEC-042-0
	Insulating spacer	AEC-043-0