

Service Manual

REVERBERATION AMPLIFIER

SR-303

 **PIONEER**[®]

MODEL SR-303 COMES IN THREE VERSIONS DISTINGUISHED AS FOLLOWS:

Type	Voltage	Remarks
KU	120V only	U.S.A. model
S	110V, 120V, 220V and 240V (Switchable)	General export model
S/G	110V, 120V, 220V and 240V (Switchable)	U.S. Military model

Although the basic features of KU, S and S/G types are the same, the variations in safety standards in different countries has also necessitated variations in power supply and circuit component specifications.

This service manual is applicable to the KU type. For servicing of the other types please refer to the additional service manual (see page 19).

CONTENTS

1. SPECIFICATIONS	2
2. FRONT PANEL FACILITIES	3
3. REAR PANEL FACILITIES	4
4. BLOCK DIAGRAM	4
5. CIRCUIT DESCRIPTIONS	5
6. DISASSEMBLY	8
7. PARTS LOCATION	9
8. ADJUSTMENT	10
9. EXPLODED VIEW	10
10. SCHEMATIC DIAGRAM, P.C. BOARD PATTERNS AND PARTS LIST	
10.1 Miscellanea	12
10.2 Schematic Diagram	13
10.3 P.C. Boards Connection Diagram	15
10.4 Parts List of P.C. Board Assemblies	17
11. PACKING	18

1. SPECIFICATIONS

Semiconductors

ICs	8
FET	1
Transistors	20
Diodes	16

Reverberation Amplifier Section

Input (Sensitivity/Impedance)	150mV/50kΩ (at 1kHz, DEPTH volume: 0)
Frequency Response	5Hz to 70kHz ±1dB (at DEPTH volume: 0)
Total Harmonic Distortion	Less than 0.05% (at 1kHz, 1V, DEPTH volume: 0)
Maximum Input Level	2V (at 1kHz, 1V, DEPTH volume: 0)
Signal to Noise Ratio	90dB (at 1V, DEPTH volume: 0)
Reverberation Time	0 to 3 sec (at EFFECT 1, 400Hz) 25msec to 100msec (at EFFECT 2, 400Hz)
Output (Level/Impedance)	150mV/1kΩ (at 1kHz, DEPTH volume: 0)

Miscellaneous

Power Requirements	110V/120V/220V/240V (switchable), 50/60Hz
Power Consumption	13W
Dimensions	420(W) x 99(H) x 336(D) mm 16-9/16(W) x 3-7/8(H) x 13-1/4(D) in
Weight (without package)	4.3kg (9 lb 8 oz)

Furnished Parts

Connection cord with pin plugs	2
Operating instructions	1

NOTE:

Specifications and the design subject to possible modification without notice due to improvements.

2. FRONT PANEL FACILITIES

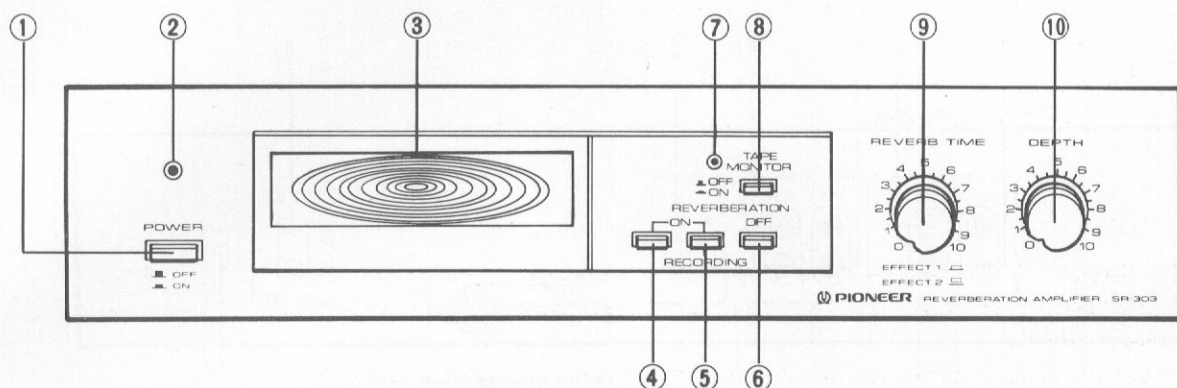

① POWER SWITCH

Power is supplied to the model SR-303 when this switch is depressed. The power indicator comes on as soon as the power is supplied.

② POWER INDICATOR

This comes on as soon as the SR-303's power switch is set to ON to indicate that power is being supplied.

③ REVERBERATION EFFECT INDICATOR

This displays the reverberation effect graphically. When the reverberation time is increased (the reverb time control is rotated clockwise), the winking intervals of the light are lengthened. Conversely, when this time is reduced (the reverb time control is rotated counterclockwise), these intervals are cut short. Also, the lighting area increases in proportion to the size of the reverberation components. This area is increased as the depth control is rotated clockwise. The reverb time and depth controls are set to the preferred position as you check out the reverberation, but if the reverberation indicator's circle of light remains on the display, it means that the reverberation components are excessive (too much of an echo). Use this as a base for adjustments.

④ REVERBERATION ON SWITCH

Depress this switch to produce a reverberation effect with the signals fed from the REVERBERATION INPUT jacks. The reverberation effect indicator will come on, and signals featuring a reverberation effect only will be fed out from the model SR-303's OUTPUT jacks.

⑤ REVERBERATION ON-RECORDING SWITCH

Depress this switch when recording a program source whose signals feature a reverberation effect onto a tape in a deck connected to the model SR-303's TAPE jacks. This will allow signals with the reverberating sound to be made available from both the SR-303's OUTPUT jacks and the TAPE REC jacks.

⑥ REVERBERATION OFF SWITCH

Depress this switch to cut off the reverberation effect. This will allow signals without a reverberating sound to be made available from both the SR-303's OUTPUT jacks and the TAPE PLAY jacks.

NOTE:

The reverberation on switch, the reverberation on-recording switch and the reverberation off switch are all coupled. When you depress one switch, make sure that all the others are released. Do not depress more than one switch at a time.

⑦ TAPE MONITOR INDICATOR

This comes on when the tape monitor switch is depressed.

⑧ TAPE MONITOR SWITCH

Depress this switch to monitor the sound on the tape as it is being recorded or when playing back a tape using a tape deck connected to the SR-303's TAPE jacks. (The tape monitor indicator comes on.)

⑨ REVERB TIME CONTROL

This is used to adjust the delay time. The reverberation effect becomes more pronounced when this control is rotated clockwise as you listen to the reproduced sound. Listen to the sound and then set this control for the optimum effect. Selection can be made between two types of reverberation with the model SR-303 by pushing the reverb time control or pulling it out. Pushing the control gives EFFECT 1 (longer reverberation time) and pulling it out gives EFFECT 2 (one reverberation component).

⑩ DEPTH CONTROL

This is used to adjust the depth of the reverberation. When it is set to the '0' position, only the original sound will be heard. The reverberation component increases as this control is rotated clockwise. Listen to the sound as it reverberates and adjust this control to the optimum position.

3. REAR PANEL FACILITIES

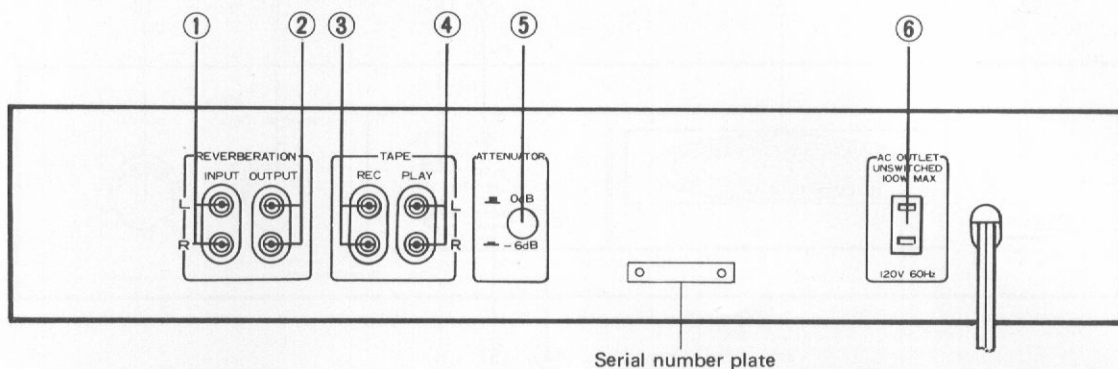

① REVERBERATION INPUT JACKS

Connect these jacks to the TAPE REC jacks on the stereo amplifier or to the PREAMP OUT (OUTPUT) jacks on the preamplifier.

② REVERBERATION OUTPUT JACKS

Connect these jacks to the TAPE PLAY jacks on the stereo amplifier or to the POWER AMP IN (INPUT) jacks on the power amplifier.

③ TAPE REC JACKS

Connect these to the INPUT (REC) jacks on the tape deck.

④ TAPE PLAY JACKS

Connect these to the OUTPUT (PLAY) jacks on the tape deck.

⑤ ATTENUATOR SWITCH

This is used to attenuate the model SR-303's input signals. It is normally set to 0dB (released position). When using the model to reverberate the sound of a program source having an extremely wide dynamic range, such as a live recording, or when the sound appears to be distorted with the switch set at the 0dB position, depress this switch and set it to the -6dB position.

NOTE:

The maximum rated input of the model SR-303 is 2V. When it is being used between the PREAMP OUT jacks of the preamplifier and the POWER AMP IN jacks of the power amplifier, set this switch beforehand to -6dB if the output level of the preamplifier will exceed 2V.

⑥ AC OUTLET

This is an auxiliary power outlet. Connect the power plug of your tape deck or other stereo hi-fi component to this outlet. It is not coupled with the power switch on the model SR-303 (UNSWITCHED). The maximum power capacity is 100W and so do not connect electrical appliances with a power capacity exceeding this value.

4. BLOCK DIAGRAM

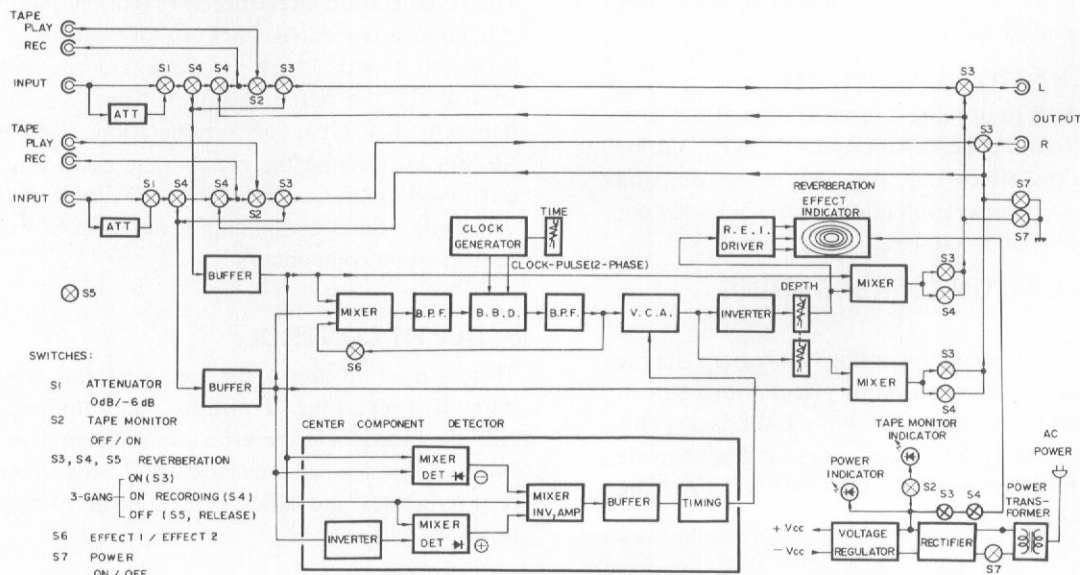

5. CIRCUIT DESCRIPTIONS

The SR-303 Reverberation Amplifier is an electronic delayed signal mixing amplifier featuring the recently developed Bucket Brigade Device (BBD).

To achieve a reverberation effect in the reproduction of sound, the original program source is mixed with a delayed component of the same program source. Conventional methods of delaying audio signals have involved the use of springs, metallic plates, and other means of transmitting mechanical vibrations, plus magnetic tapes and discs. In comparison to these methods, the electronic BBD is small and compact, resistant to the effects of external vibrations, and permits free adjustment of delay time.

Operating Principles of the BBD

The BBD is a kind of charge-transfer device made with a large number of capacitors and transistors arranged alternately on a semiconductor base (see Fig. 5-1). Each pair of adjacent capacitor and transistor (called a stage) is driven by a 2-phase clock pulse signal (180° phase difference), resulting in the input signal being relayed from stage to stage in "bucket brigade" fashion down to the output capacitor. Delay time will therefore depend on the number of capacitor/transistor pairs (stages) which in turn may be adjusted by varying the frequency of the clock pulses.

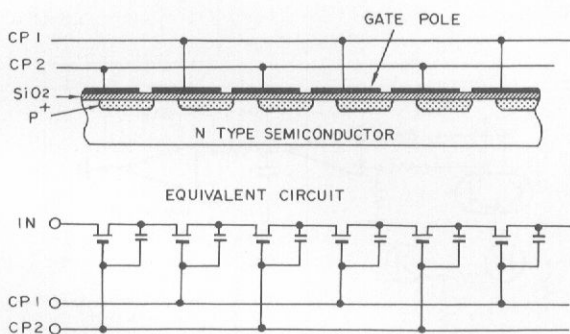

Fig. 5-1 Constitution of BBD

Features of the SR-303 Reverberation Amplifier

Single Delay and Echo

A single delay is obtained by adding the delay single once only (see Fig. 5-2A). For this operation, the front panel REVERB TIME control is pulled out into the EFFECT 2 position.

The echo effect is obtained by applying the signal which has already been delayed once back

into the delay circuit (see Fig. 5-2B). This requires the REVERB TIME control to be pushed back into the EFFECT 1 position. In the circuit diagram outlined in Fig. 5-3, S_6 corresponds to the EFFECT 1/EFFECT 2 switch.

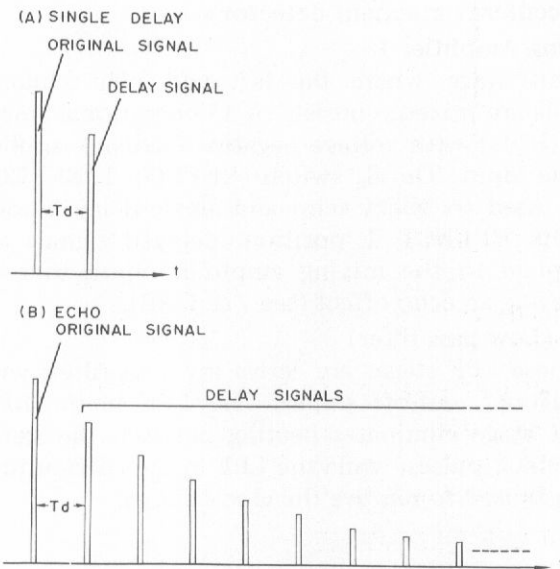

Fig. 5-2 Delay Pattern

Dynamic Delay

The dynamic delay function varies the degree of mixing depending on the relative level of the centrally localized components when adding the delay signal to the original signal. If the level of these components is high, the level of the delayed signal will be increased. The delayed component will thus be increased at higher volume levels during vocalist and solo instrumental performance, thereby attaining a more natural reverberation effect. At low volume levels, the delayed signal components are suppressed. The level of noise generated in the BBD is also decreased, resulting in an improved S-N ratio.

Furthermore, since the reverberation effect appears to be obtained only with the centrally localized components, sufficient reverberation may also be obtained by delaying the mixed left and right channels and applying the result to both channels.

Delay Signal Mixing Circuit

See Fig. 5-3 for an outline of the delay signal mixing circuit.

Buffer Amplifier

The left and right channel input signals are applied to the buffer amplifier stage (SEPP circuit consisting of PNP and NPN transistors). The output signal is applied to the mixing amplifier and center component detector stages.

Mixing Amplifier 1

This stage where the left and right channel signals are mixed, consists of an operational amplifier (IC-1/2) with voltage negative feedback applied to the input. The S₆ switch (EFFECT 1/EFFECT 2) is used to select echo and single delay modes. In the EFFECT 1 position, delayed signals are reapplied to the mixing amplifier input, thereby achieving an echo effect (see Fig. 5-2B).

LPF (Low-pass filter)

These LPF stages are active low-pass filters with -36dB/oct. cut-off slopes. The LPF in the BBD input stage eliminates beating between the signal and clock pulses, while the LPF in the BBD output stage is used to remove the clock pulses.

HPF (High-pass filter)

The 2 HPF stages (in the BBD input and output stages) are used to attenuate the low frequency components which would otherwise lead to a rather undesirable reverberation effect.

BBD (Bucket Brigade Device)

This 2048-stage MOS type BBD IC (MN3008) has been designed to vary the delay time between 25.6 and 102.4ms by adjustments of the clock frequency (10kHz to 40kHz range).

Clock Generator

The clock generator employs a hex inverter CMOS logic IC (μ PD4069C) which features an astable multivibrator formed by 2 inverters. The 2-phase clock pulse signal consists of the output obtained from 1 inverter plus the output obtained from both inverters.

By varying the gate voltage of the FET employed as a variable resistance element in the oscillator time constant circuit, the change in the internal resistance will alter the oscillator frequency. The FET gate voltage, and consequently the delay time, is changed by adjusting the REVERB TIME control located on the front panel.

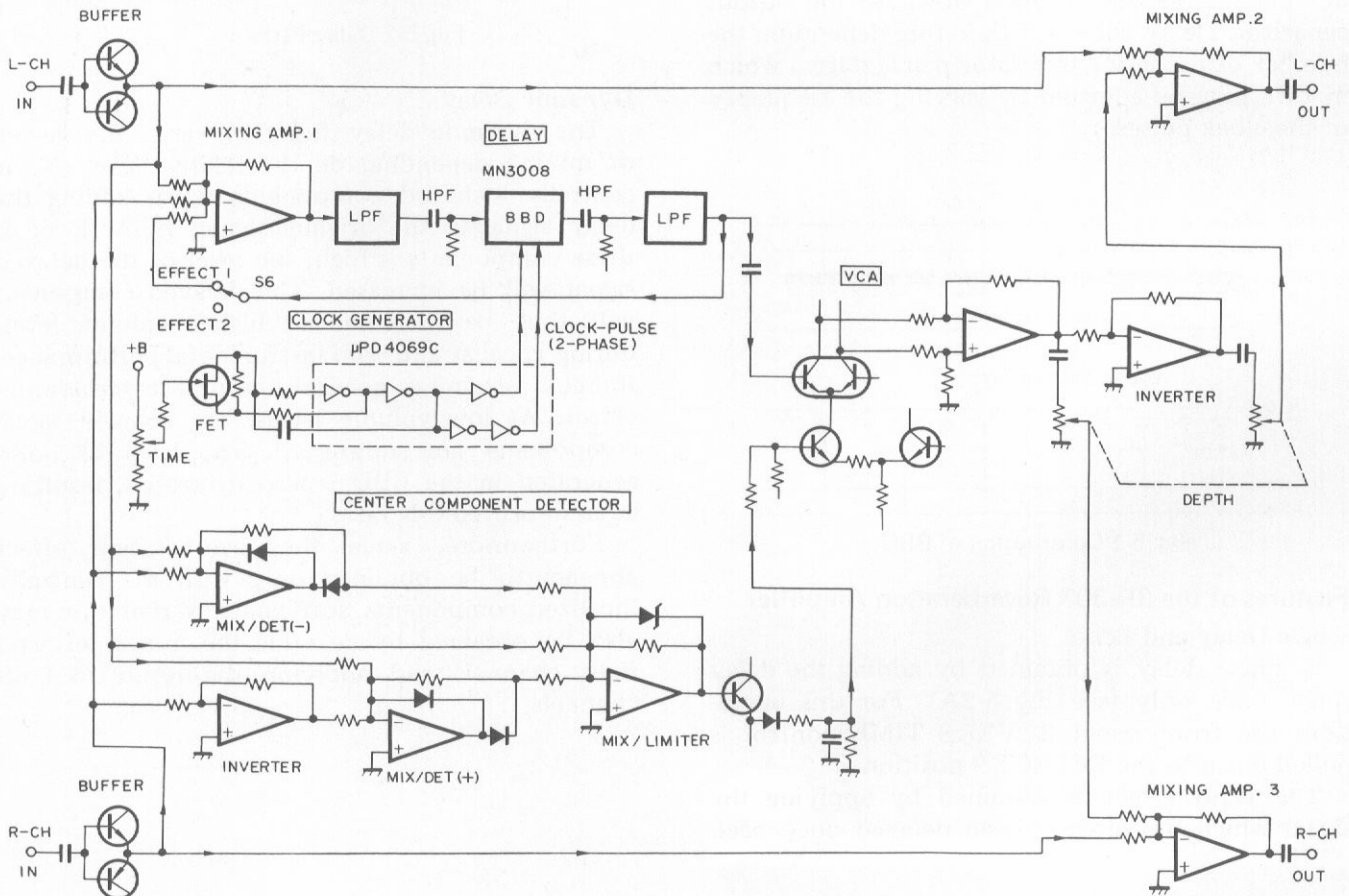

Fig. 5-3 Delay Signal Mixing Circuit

VCA (Voltage Controlled Amplifier)

The VCA component is an amplifier capable of controlling gain by voltage changes, and is employed in the dynamic delay function. This gain control is achieved by using a control voltage from the center component detector to vary the common emitter current of the differential amplifier.

Mixing Circuit

After first adjusting the level of the VCA output signal, this signal is mixed with the left and right channel original signal in mixing amplifiers 2 and 3. The delay signal applied to the left channel is passed through an inverter where the phase is inverted (in respect to the right channel delay signal). This step eliminates the localization of the delay signal, resulting in a much more natural reverberation effect.

Center Component Detector

This circuit detects the centrally localized components of the stereo signal, and applies a resultant control voltage to the VCA for the dynamic delay operation. The constitution of this circuit is shown in Fig. 5-4.

R.E.I. Driver Circuit

The SR-303 is equipped with a Reverberation Effect Indicator used to display the reverberation status obtained, and this R.E.I. driver circuit is employed to drive the necessary illumination lamps (see Fig. 5-6).

The dynamic range of the input signal (delay signal) is first compressed and rectified, the resultant signal then passed through 3 lamp driver transistors, each of a different operational point. Hence, each lamp will light up independently, depending on the level of the delay signal.

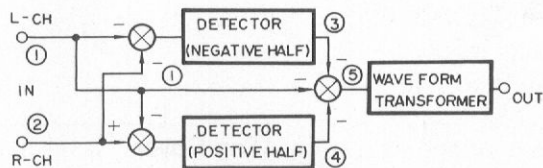

Fig. 5-4 Center Component Detector

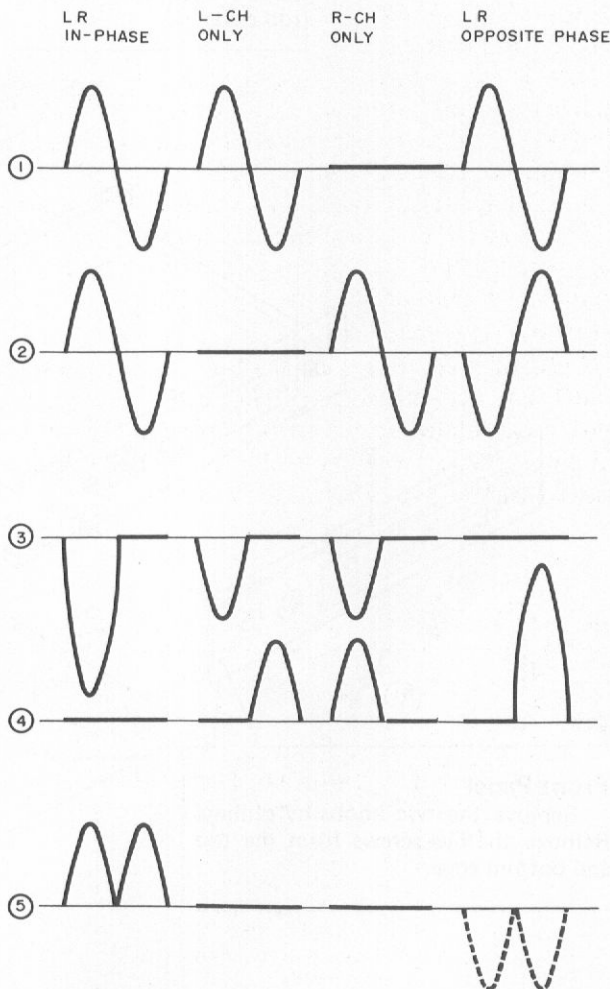

Fig. 5-5 Wave Forms in Center Component Detector

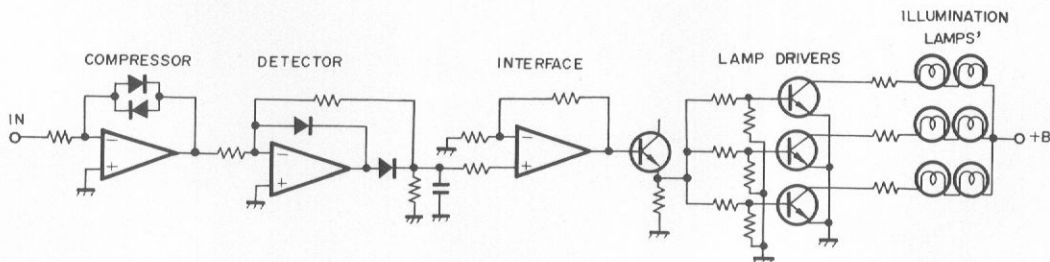
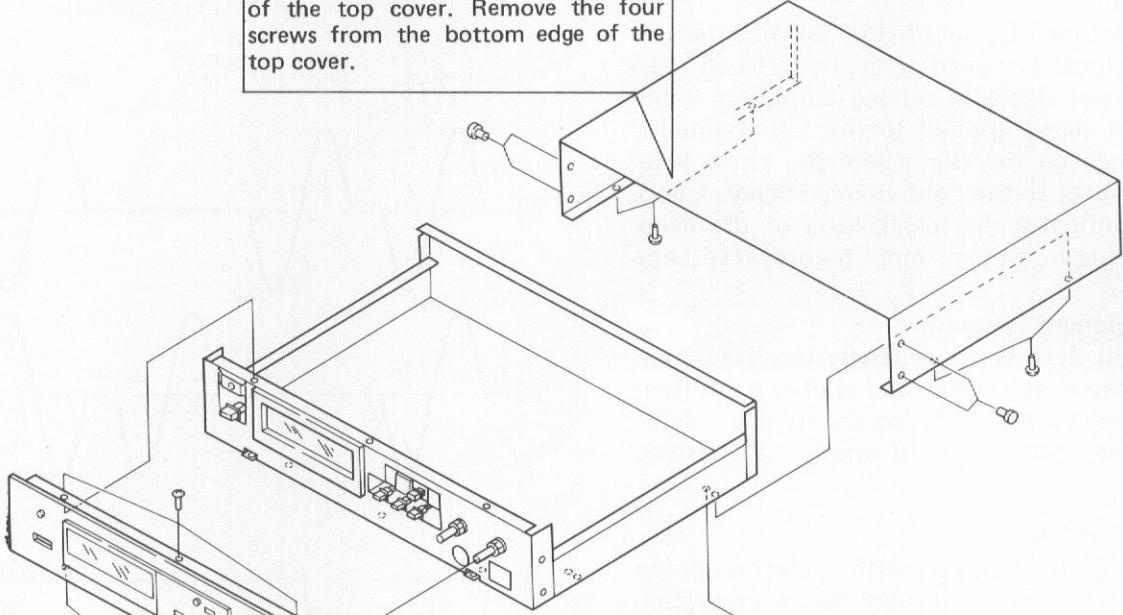

Fig. 5-6 R.E.I. Driving circuit

6. DISASSEMBLY

Top Cover
Pull off the two caps on each side of the top cover. Remove the four screws from the bottom edge of the top cover.



Bottom Plate
Remove the ten screws to detach the bottom plate.

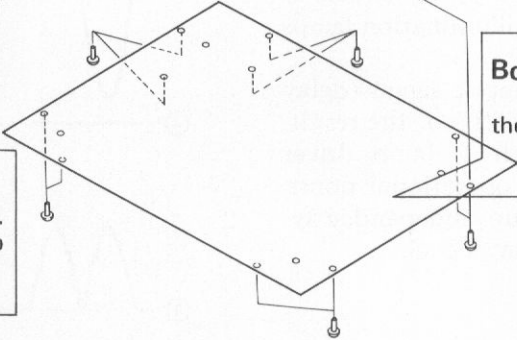

Front Panel
Remove the two knobs by pulling. Remove the five screws from the top and bottom edge.

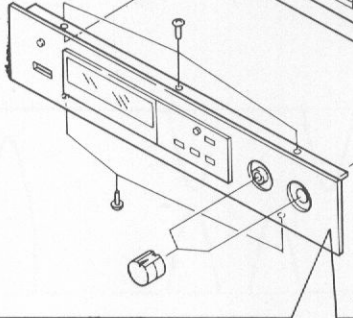

7. PARTS LOCATION

Front Panel View

- The ⚠ mark found on some component parts indicates the importance of the safety factor of the part. Therefore, when replacing, be sure to use parts of identical designation.

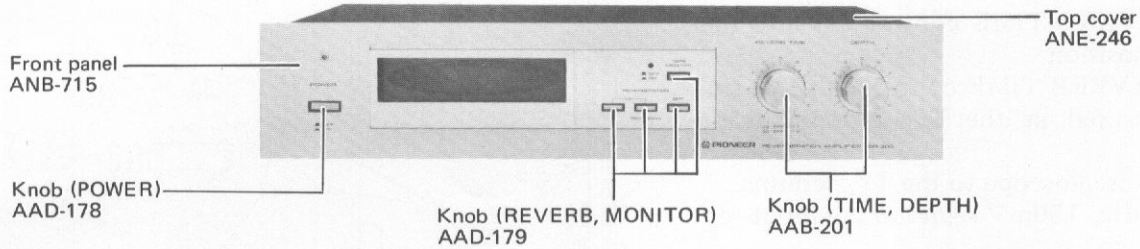

Front View with Panel Removed

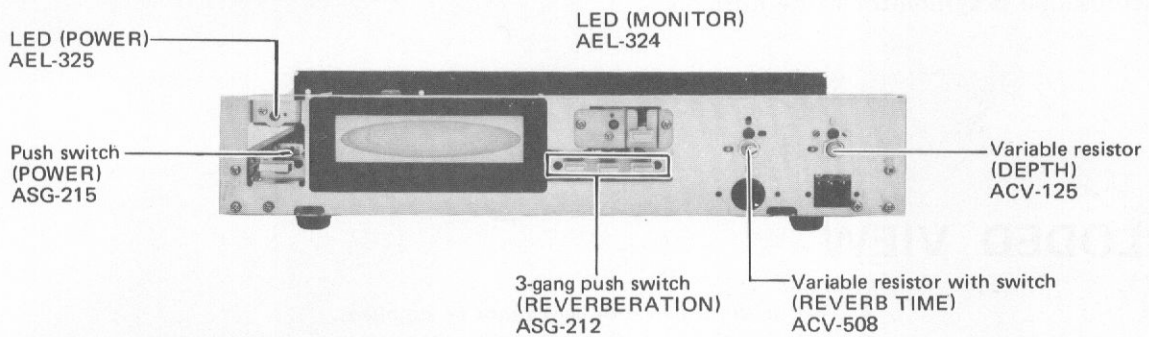

Top View

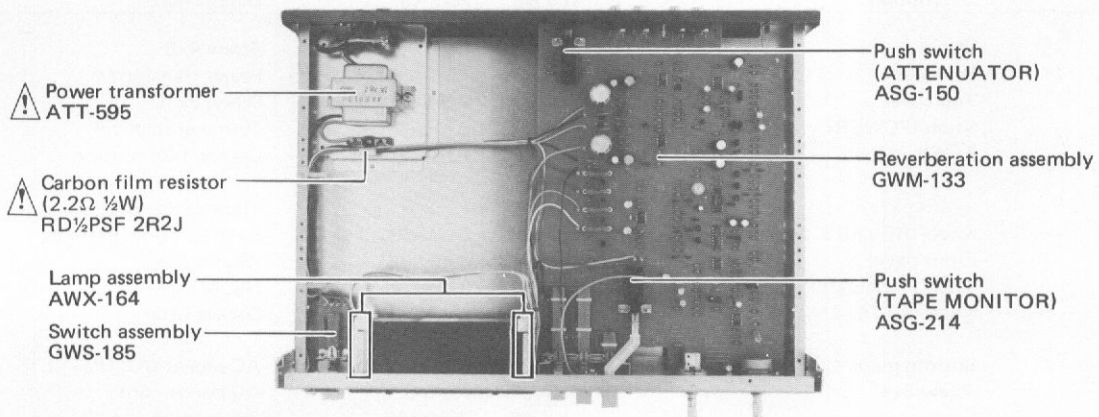

Rear Panel View

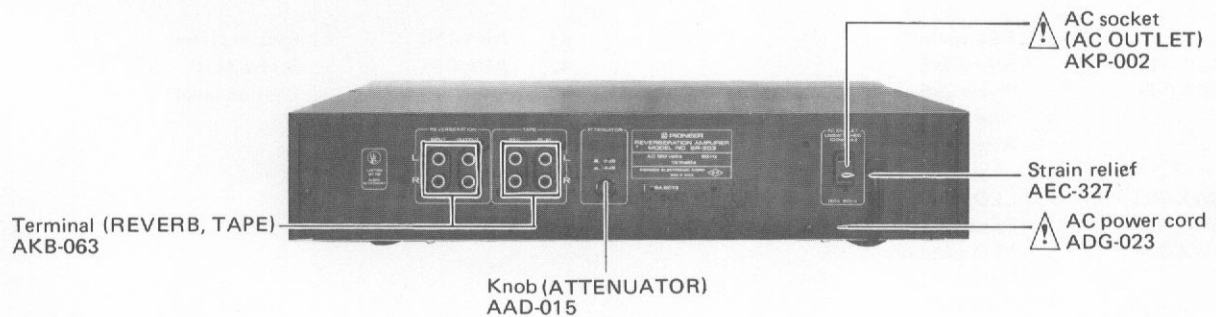

8. ADJUSTMENTS

1. Set the ATTENUATOR switch to 0dB.
2. Press the REVERBERATION ON switch (i.e. switch on).
3. Check that the TAPE MONITOR switch is OFF.
4. Pull the REVERB TIME control out into the EFFECT 2 position.
5. Turn the REVERB TIME control until the frequency measured at the TP₁ terminal reads 20kHz.
6. Connect the oscilloscope to the TP₂ terminal.
7. Apply a 400Hz, 150mV signal to the input terminals.
8. Then adjust VR₃ so that the waveform shown in the oscilloscope is symmetrical the horizontal axis.

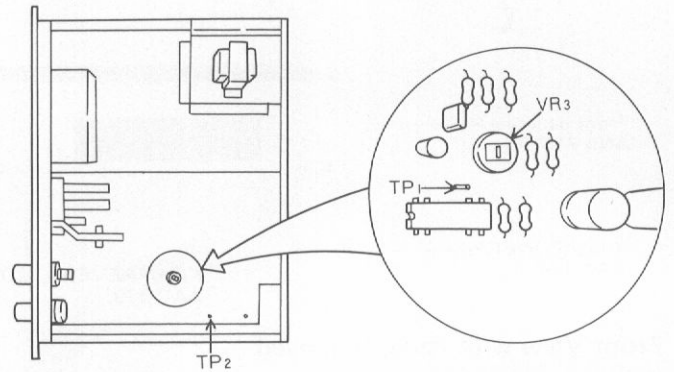

9. EXPLODED VIEW

NOTES:

- Parts without part number cannot be supplied.
- The \triangle mark found on some component parts indicates the importance of the safety factor of the part. Therefore, when replacing, be sure to use parts of identical designation.

Parts List

Key No.	Part No.	Description	Key No.	Part No.	Description
1.	AEB-151	Cap	26.	ABA-069	Screw 4x8
2.	ABA-228	Screw 3x6	\triangle 27.	ATT-595	Power transformer
3.	ANE-246	Top cover	28.	ABA-050	Screw 3x10
4.	AAD-178	Knob (POWER)	29.		Terminal strip 2-P
5.		Extension bar	\triangle 30.	RD $\frac{1}{2}$ PSF 2R2J	Carbon film resistor
6.		31.		Transformer base
7.	AAD-179	Knob (REVERB, MONITOR)	32.	GWM-133	Reverberation assembly
8.	ANB-715	Front panel	33.	M45-086	Washer M9
9.	AAB-201	Knob (TIME, DEPTH)	34.	B71-004	Nut M9
10.	AAD-015	Knob (ATTENUATOR)	35.		Socket fitter
11.		Bottom plate	\triangle 36.	AKP-002	AC socket (AC OUTLET)
12.	ABA-048	Screw 3x6	\triangle 37.	ADG-023	AC power cord
13.	AEC-351	Foot	38.	AEC-327	Strain relief
14.	ABA-071	Screw 4x16	39.		Rear panel
15.	AWX-164	Lamp assembly	40.	ABA-003	Screw 3x10
16.		REI assembly	41.	ABA-115	Special screw
17.	ABA-049	Screw 3x8	42.	ABA-082	Screw 3x10
18.	ABA-065	Screw 3x6	43.		Caution label
19.		Side frame			
20.		Wire saddle			
21.	GWX-303	LED assembly 1			
22.	GWS-185	Switch assembly			
23.	GWX-304	LED assembly 2			
24.		Holder			
25.		Sub-panel			

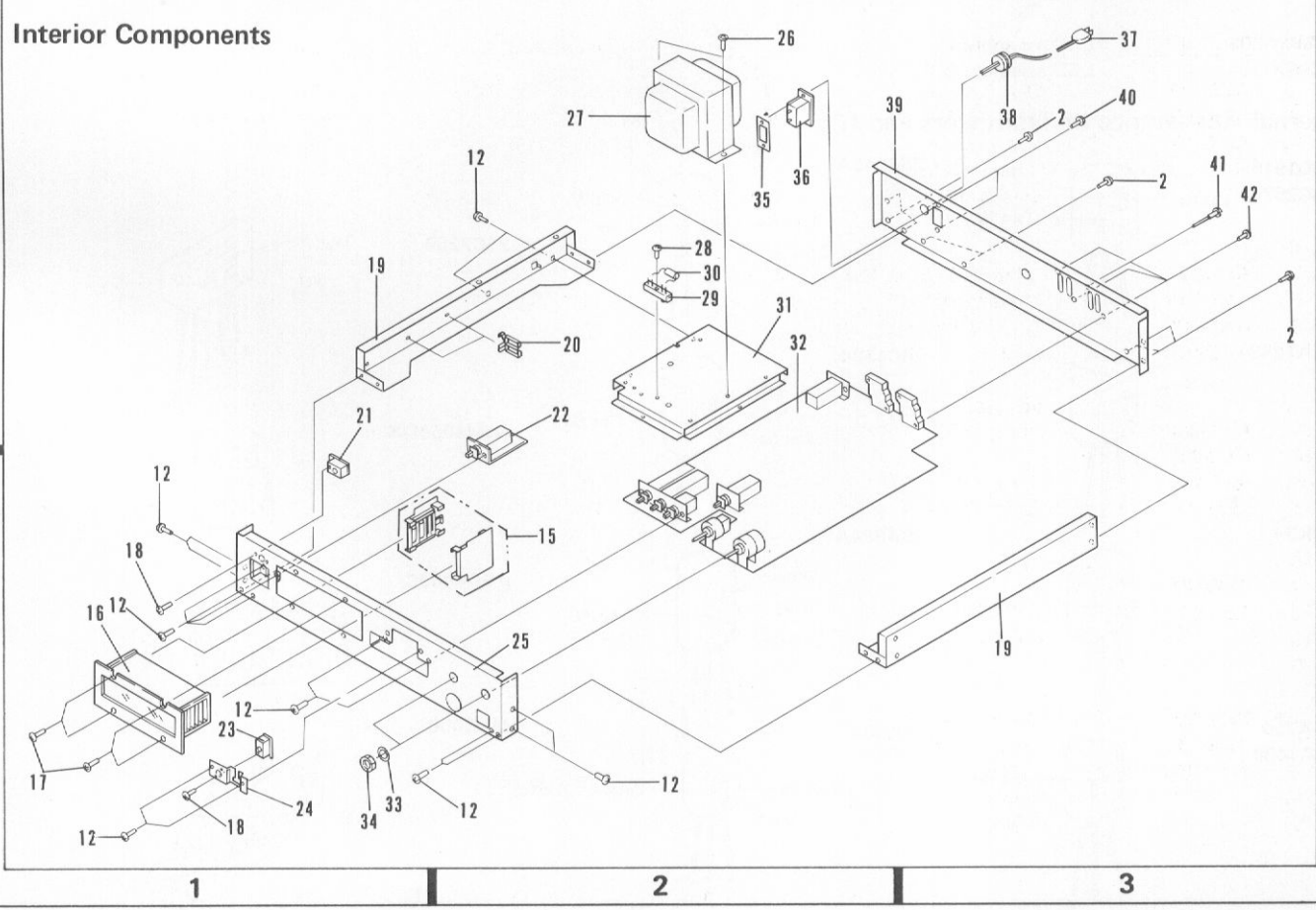
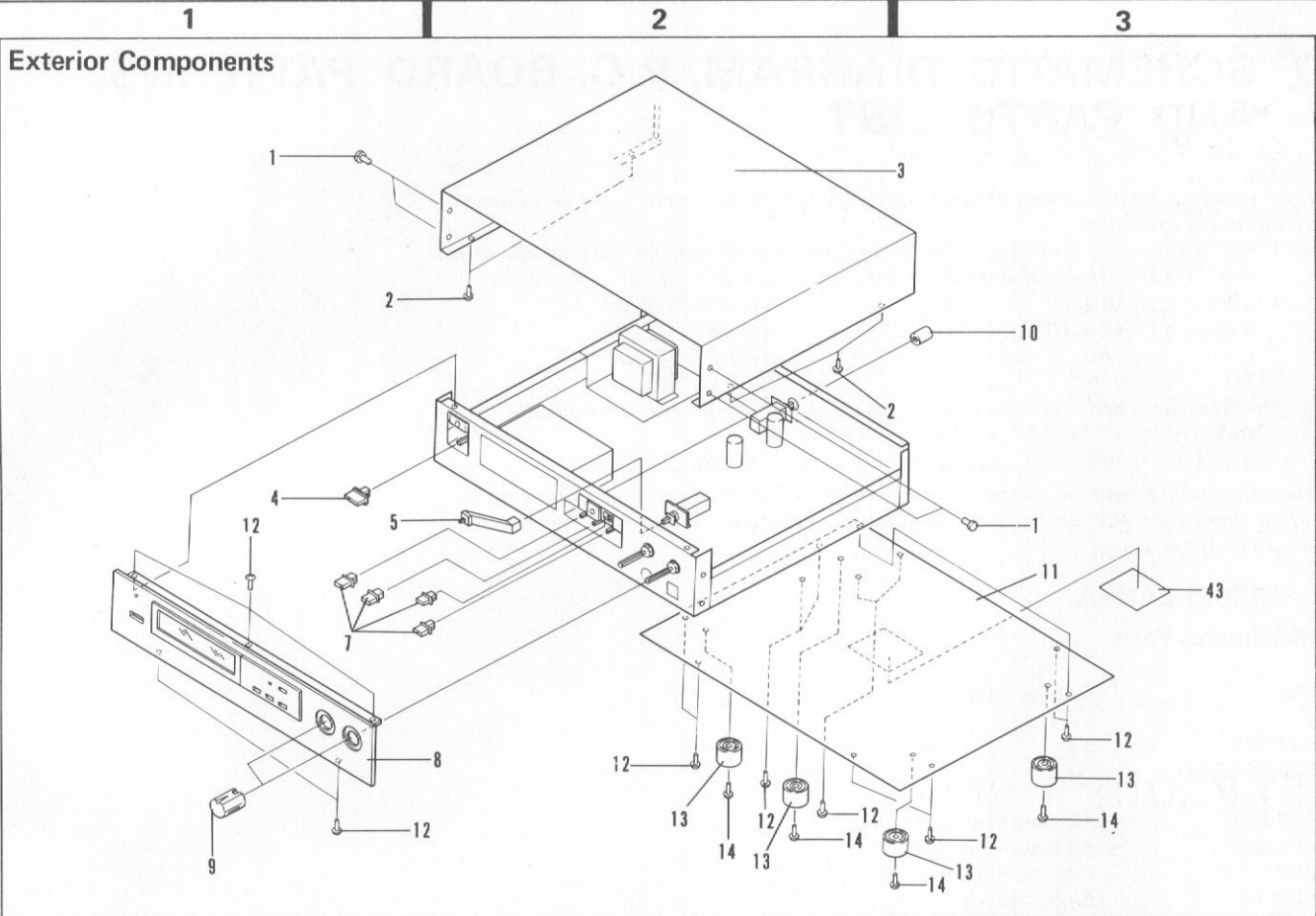

10. SCHEMATIC DIAGRAM, P.C. BOARD PATTERNS AND PARTS LIST

NOTES:

- When ordering resistors, first convert resistance values into code form as shown in the following examples.

Ex. 1 When there are 2 effective digits (any digit apart from 0), such as 560 ohm and 47k ohm (tolerance is shown by J = 5%, and K = 10%).

560Ω 56 × 10¹ 561 RD½PS 561J
 47kΩ 47 × 10³ 473 RD½PS 473J
 0.5Ω 0R5 RN2H 0R5K
 1Ω 010 RSIP 010K

Ex. 2 When there are 3 effective digits (such as in high precision metal film resistors).

5.62kΩ 562 × 10¹ 5621 RN½SR 5621F

- The Δ mark found on some component parts indicates the importance of the safety factor of the part. Therefore, when replacing, be sure to use parts of identical designation.

10.1 MISCELLANEA

Miscellaneous Parts

Part No.	Symbol & Description
Δ ATT-595	T1 Power transformer
Δ RD½PSF 2R2J	R1 Carbon film resistor
Δ AKP-002	AC socket (ACOUTLET)
Δ ADG-023	AC power cord
GWM-133	Reverberation assembly
GWS-185	Switch assembly
AWX-164	Lamp assembly
GWX-303	LED assembly 1
GWX-304	LED assembly 2

External Appearance of Transistors and ICs

2SC1919
2SC2575

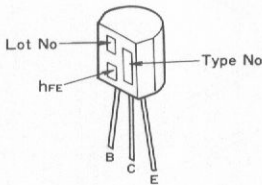

2SC945A

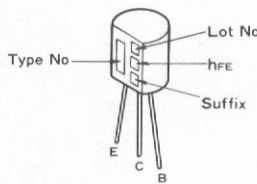

2SC2259

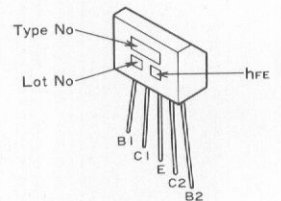

2SA726S

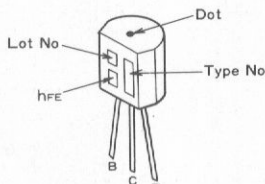

2SC1384

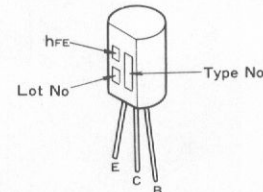

NJM4558DX

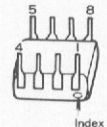

2SK34

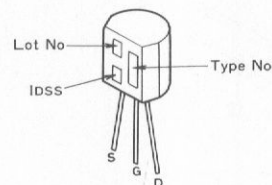

2SA684A

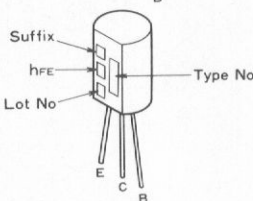

μPD4069C

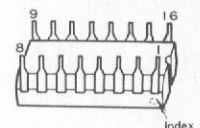

2SA750
2SC1400

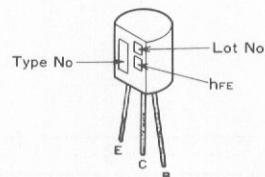

2SK30A

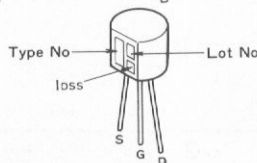

MN3008

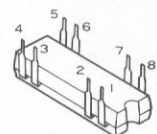

10.2 SCHEMATIC DIAGRAM

NOTE:
The indicated semiconductors are representative ones only. Other alternative semiconductors may be used and are listed in the parts list.

REVERBERATION Ass'y GWM-133

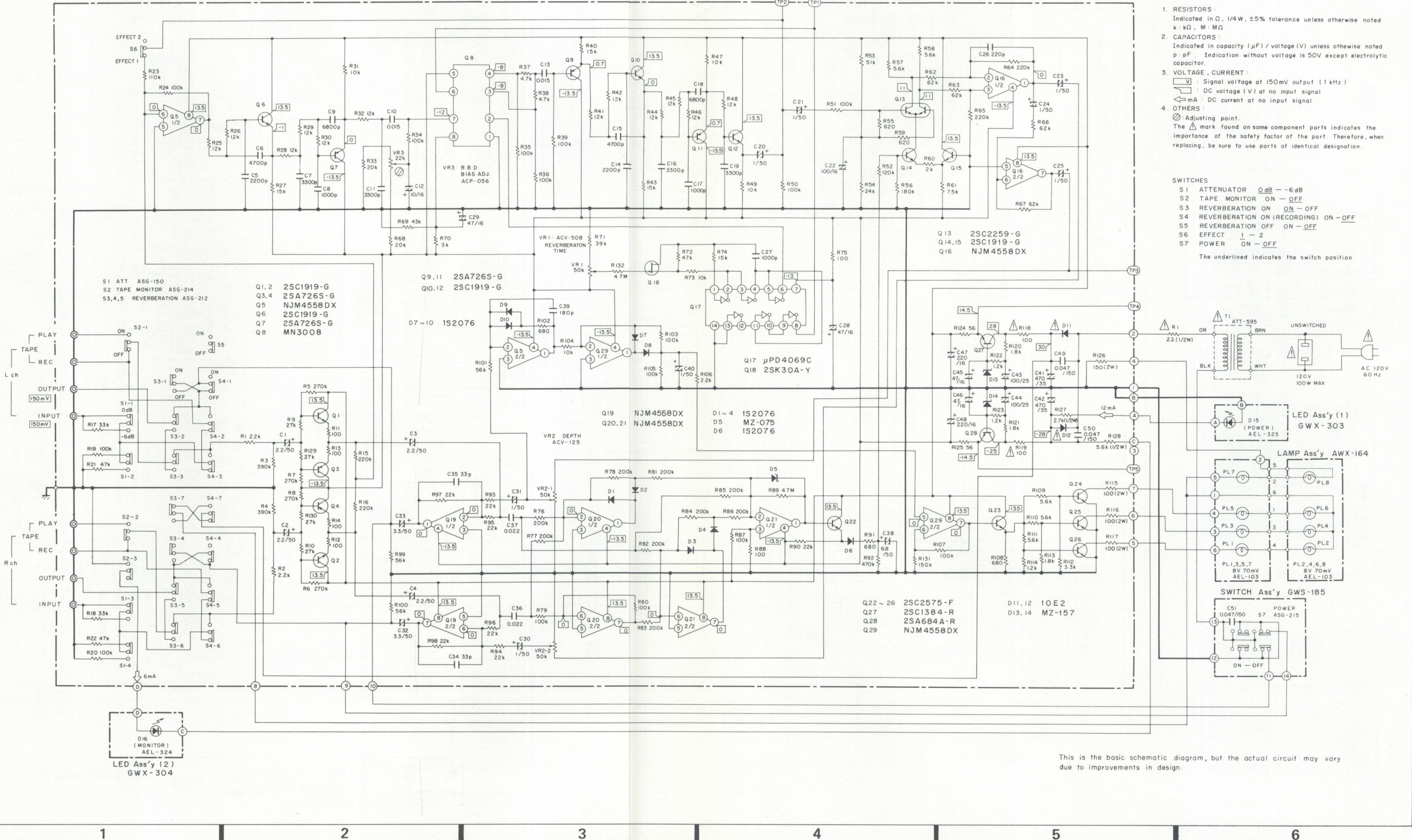

This is the basic schematic diagram, but the actual circuit may vary due to improvements in design.

10.3 P.C. BOARDS CONNECTION DIAGRAM

REVERBEATION ASSEMBLY (GWM-133)

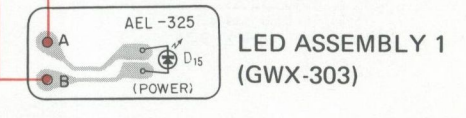
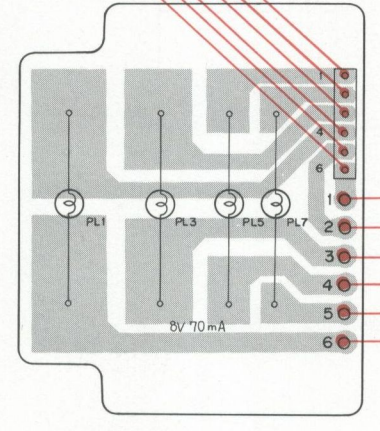
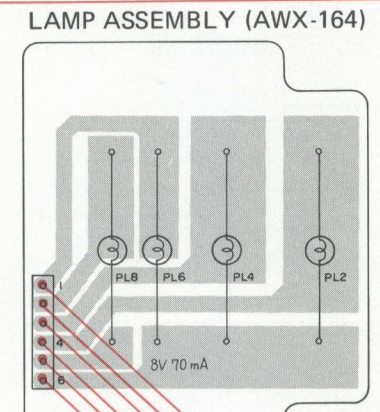
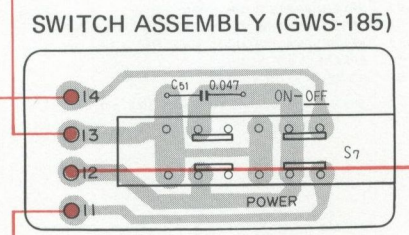
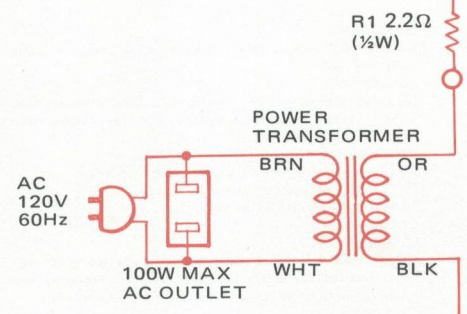
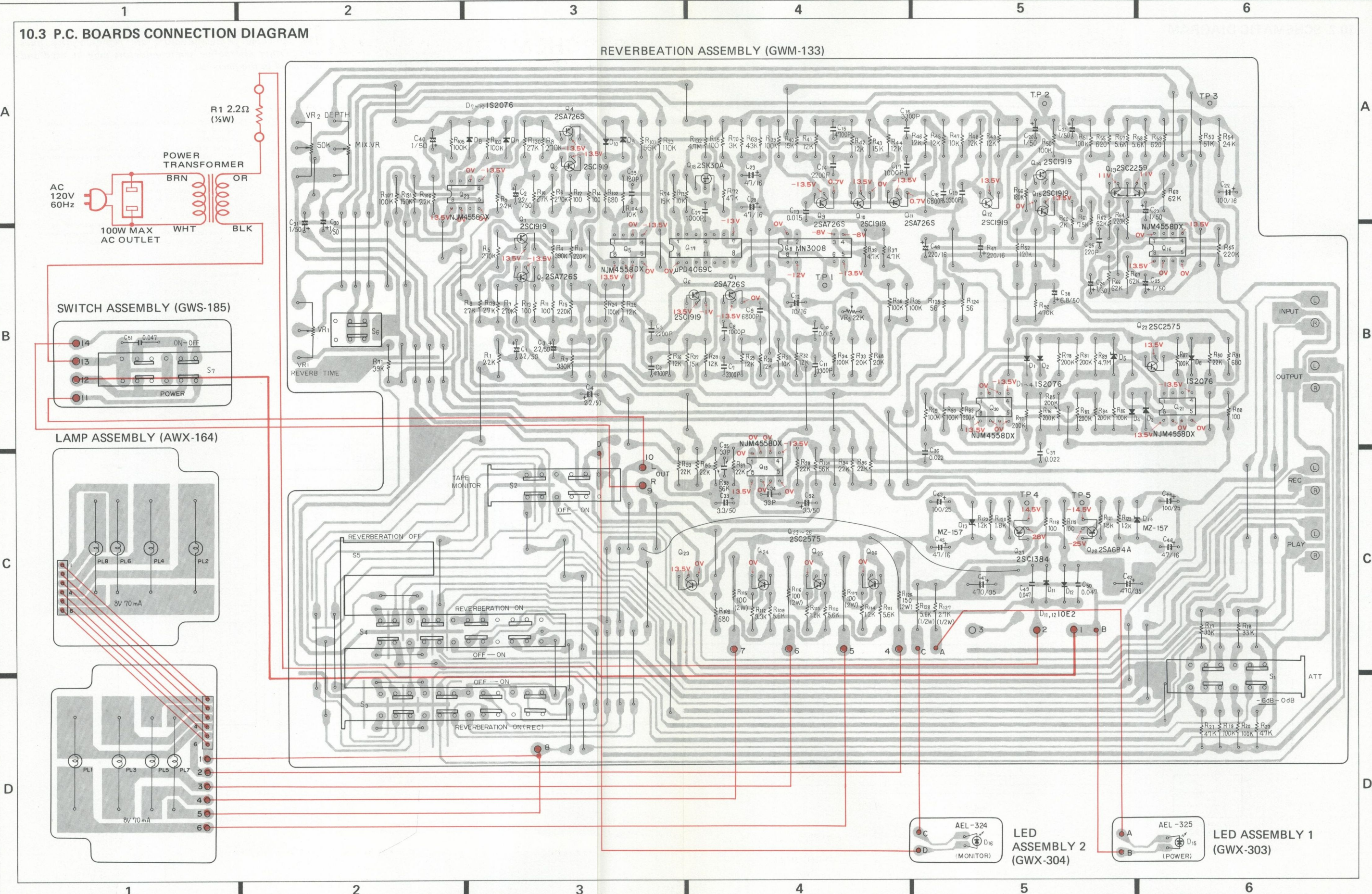

10.4 PARTS LIST OF P.C. BOARD ASSEMBLIES

Reverberation Amplifier Assembly (GWM-133)

SEMICONDUCTORS

Part No.	Symbol & Description
2SC1919 (2SC1400-E)	Q1, Q2, Q6, Q10, Q12, Q14, Q15
2SA726S (2SA750-E)	Q3, Q4, Q7, Q9, Q11
NJM4558DX	Q5, Q16, Q19-Q21, Q29
MN3008	Q8
2SC2259	Q13
μ PD4069C	Q17
2SK30A-Y (2SK34-C)	Q18
2SC2575 (2SC945A)	Q22-Q26
2SC1384	Q27
2SA684A	Q28
1S2076 (1S1555)	D1-D10
MZ-075 (WZ-075)	D5
Δ 10E2 (SIB01-02)	D11, D12
MZ-157 (WZ-157)	D13, D14

CAPACITORS

Part No.	Symbol & Description
CEANL 2R2M 50	C1-C4
CEA 100P 16	C12
CEANL 010M 50	C20, C21, C23-C25, C30, C31, C40
CEA 101P 16	C22
CEA 470P 16	C28, C29, C45, C46
CEANL 3R3M 50	C32, C33
CEANL 6R8M 50	C38
CEA 471P 35	C41, C42
CEA 101P 25	C43, C44
CEA 221P 16	C47, C48
CQMA 222J 50	C5, C14
CQMA 472J 50	C6, C15
CQMA 332J 50	C7, C11, C16, C19
CQMA 102J 50	C8, C17, C27
CQMA 682J 50	C9, C18
CQMA 153J 50	C10, C13
CQMA 223J 50	C36, C37
CCDSL 221K 50	C26
CCDSL 330K 50	C34, C35
CCDSL 181K 50	C39
ACG-009	C49, C50 Ceramic 0.047/150V

SWITCHES

Part No.	Symbol & Description
ASG-150	S1 Push (ATTENUATOR)
ASG-214	S2 Push (TAPE MONITOR)
ASG-212	S3, S4, S5 3-gang push (REVERBERATION)

Note: When ordering resistors, convert the resistance value into code form, and then rewrite the part no. as before.

RESISTORS

Part No.	Symbol & Description
ACV-508	VR1 (S6) Variable resistor with switch (REVERB TIME)
ACV-125	VR2 Variable resistor (DEPTH)
ACP-056	VR3 Semifixed 22k-B
RD $\frac{1}{2}$ PM $\square\square\square$ J	R1-R114, R120-R125, R129-R132
RS2P $\square\square\square$ J	R115-R117, R126
Δ RD $\frac{1}{2}$ PSF $\square\square\square$ J	R118, R119
RD $\frac{1}{2}$ PS $\square\square\square$ J	R127, R128

OTHERS

Part No.	Description
AKB-063	Terminal (REVERB, TAPE)

Lamp Assembly (AWX-164)

Part No.	Symbol & Description
AEL-103	PL1-PL8 Lamp 8V 70mA (bar-type)
AEC-558	Nylon rivet

Switch Assembly (GWS-185)

Part No.	Symbol & Description
ASG-215	S7 Push switch (POWER)
ACG-009	C51 Ceramic capacitor 0.047/150V

LED Assembly 1 (GWX-303)

Part No.	Symbol & Description
AEL-325	D15 LED (POWER)
ABA-065	Screw 3x6

LED Assembly 2 (GWX-304)

Part No.	Symbol & Description
AEL-324	D16 LED (MONITOR)
ABA-065	Screw 3x6

11. PACKING

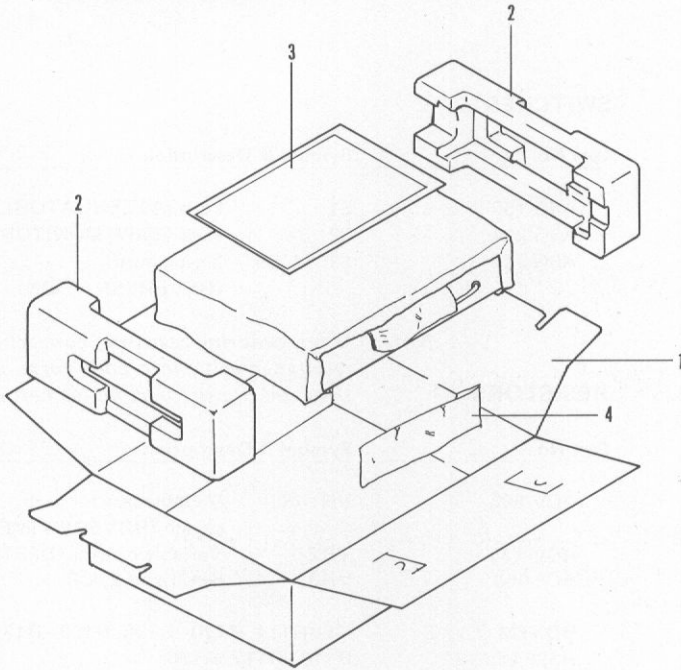

Key No.	Part No.	Description
1.	AHD-681	Packing case
2.	AHA-201	Side pad
3.	ARB-316	Operating instructions
4.	ADE-005	Connection cord

RACK MOUNT ADAPTORS

The JA-R104 rack mount adaptors are available as options. They have a 2U size format which meets EIA (Electronic Industries Association) standards and so by attaching the rack mount adaptors to the model, it can be installed into a rack conforming to EIA standards.

Attaching the JA-R104 rack mount adaptors

1. Detach the rubber bushes from both sides of the model.
2. Use the mounting screws which are accessory to the JA-R104 and mount as in Fig.A.

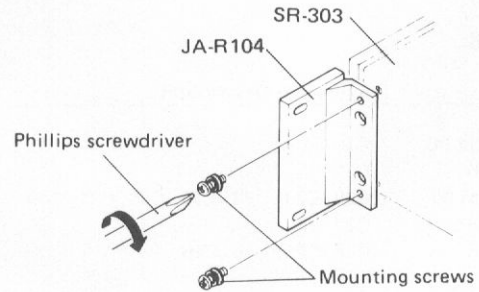

Fig. A

NOTE:

The JA-R104 adaptors are 3 mm thick. When aligning them with other Pioneer stereo components with a thickness of 5 mm, slide the accessory spacers behind the adaptors and then attach (Fig.B).

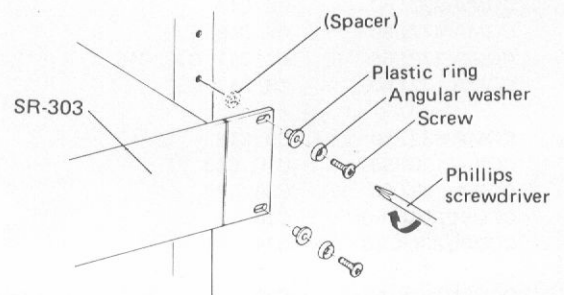

Fig. B