

STEREO PREAMPLIFIER

SC-3000

HVW

6

Power supply ass'y AWR-037

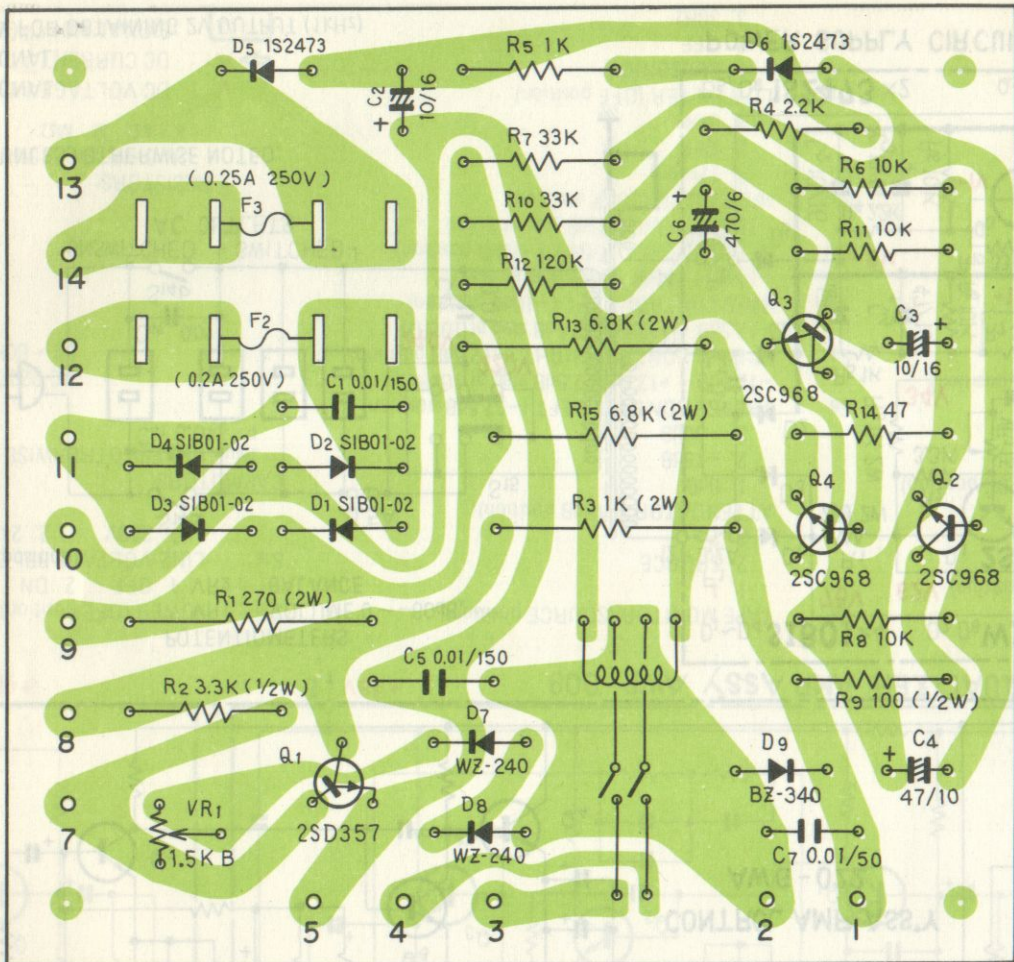

Equalizer amp ass'y AWF-009

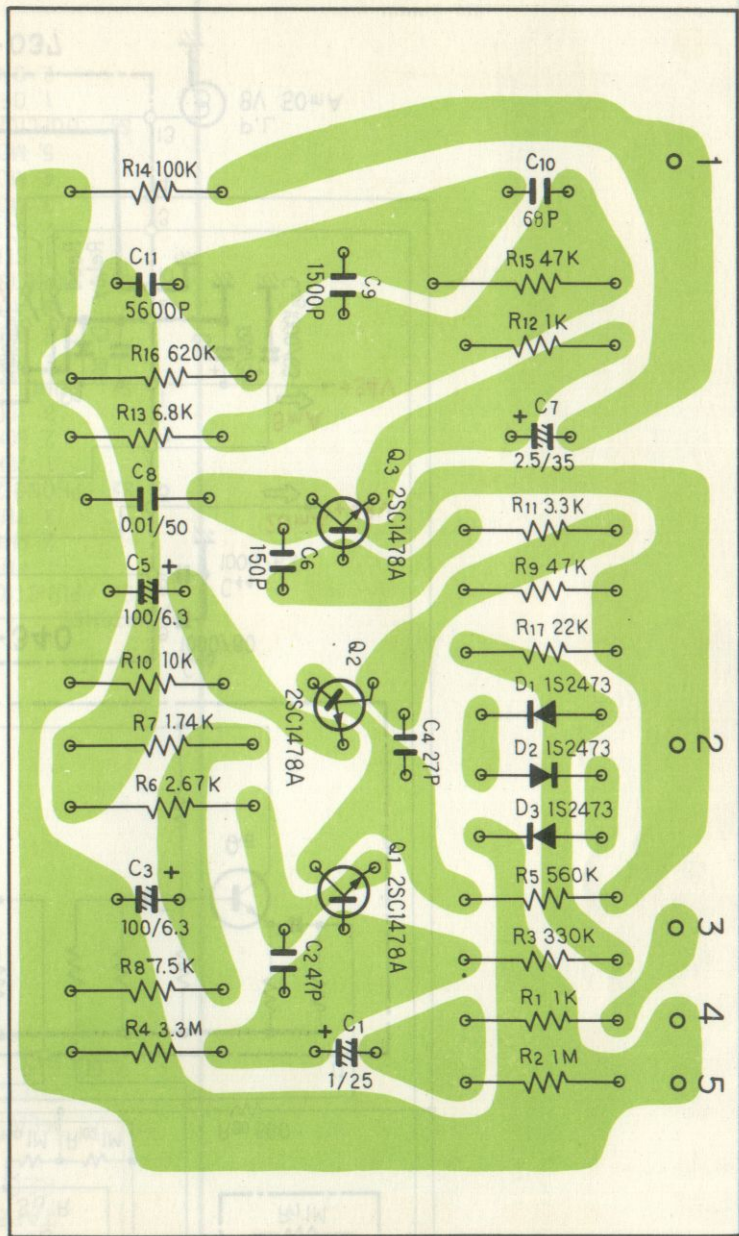

Control amp ass'y AWG-022

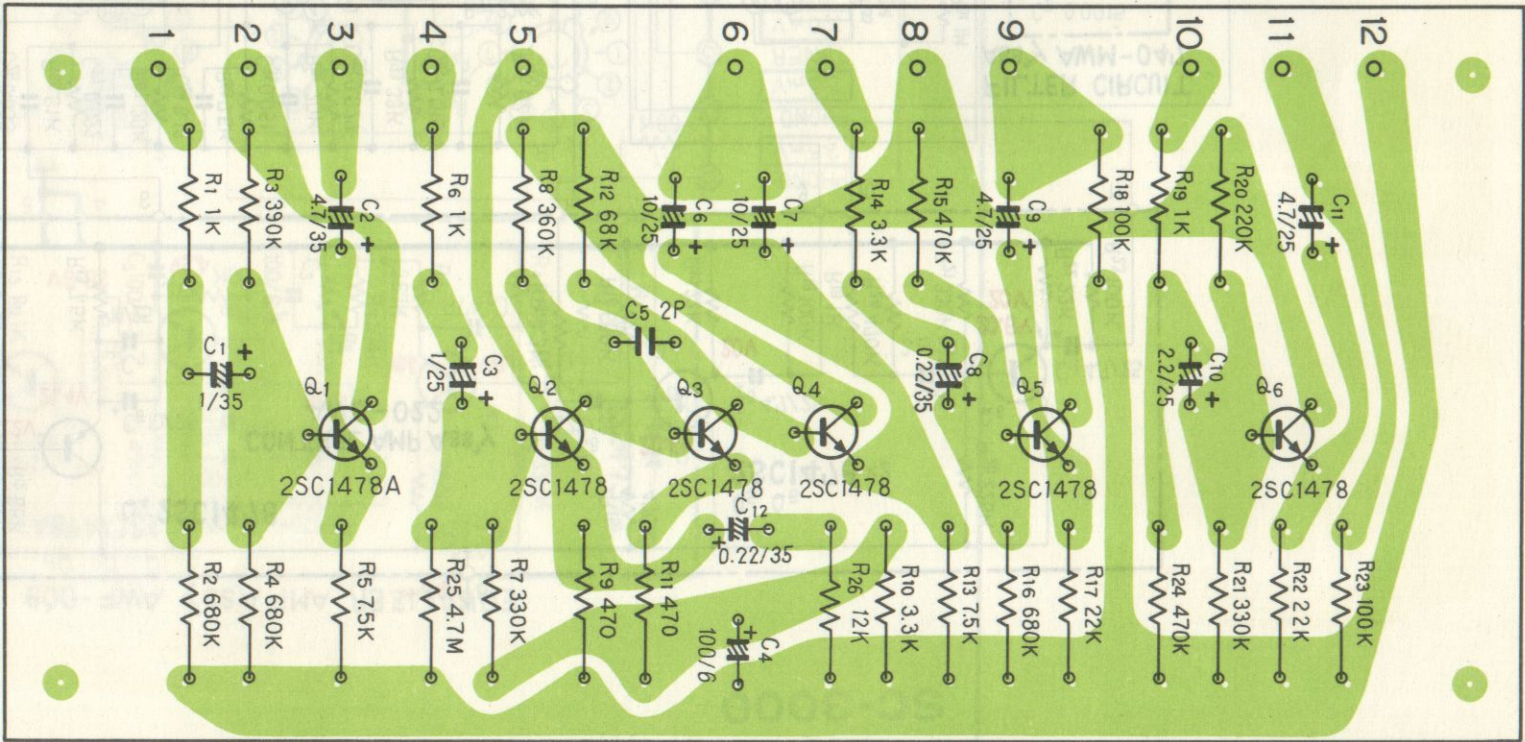

Filter amp ass'y AWM-047

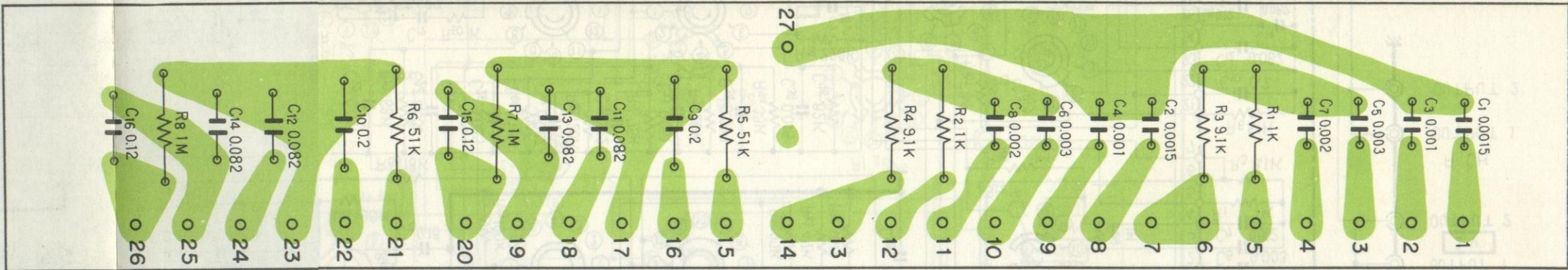

EQUALIZER AMP ASS'Y AWF-009

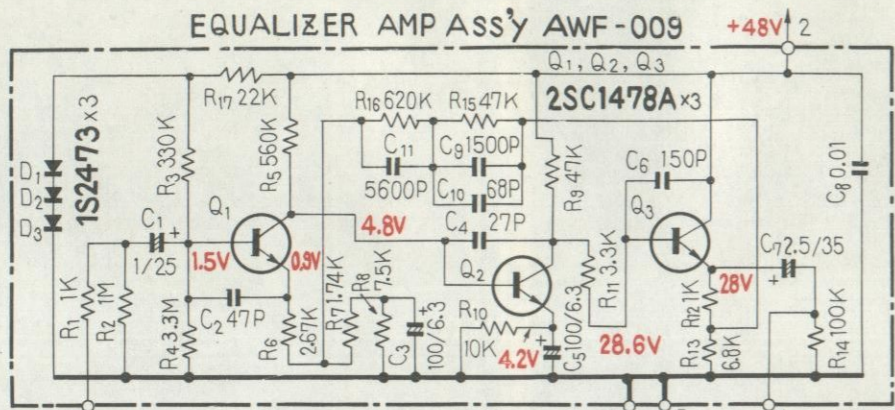

CONTROL AMP ASS'Y AWG-022

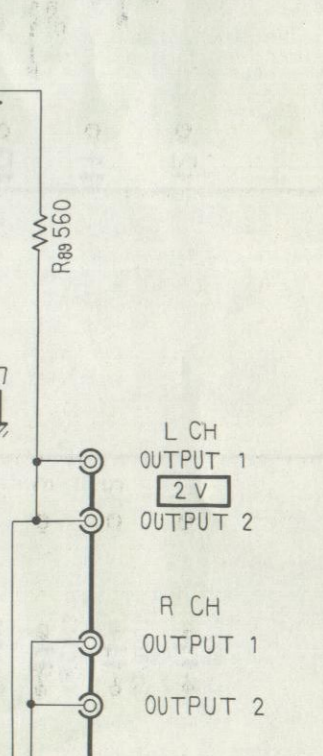
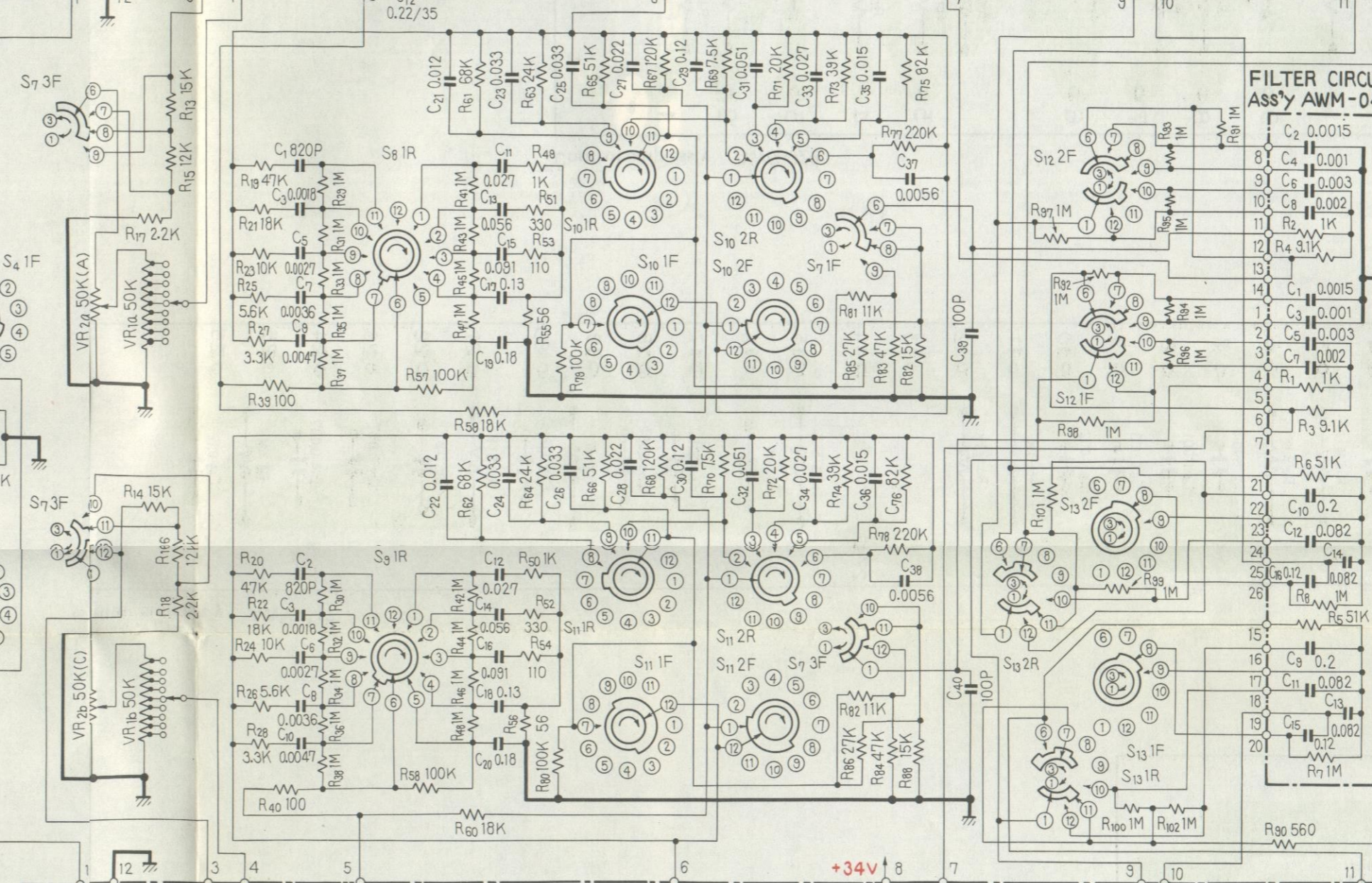
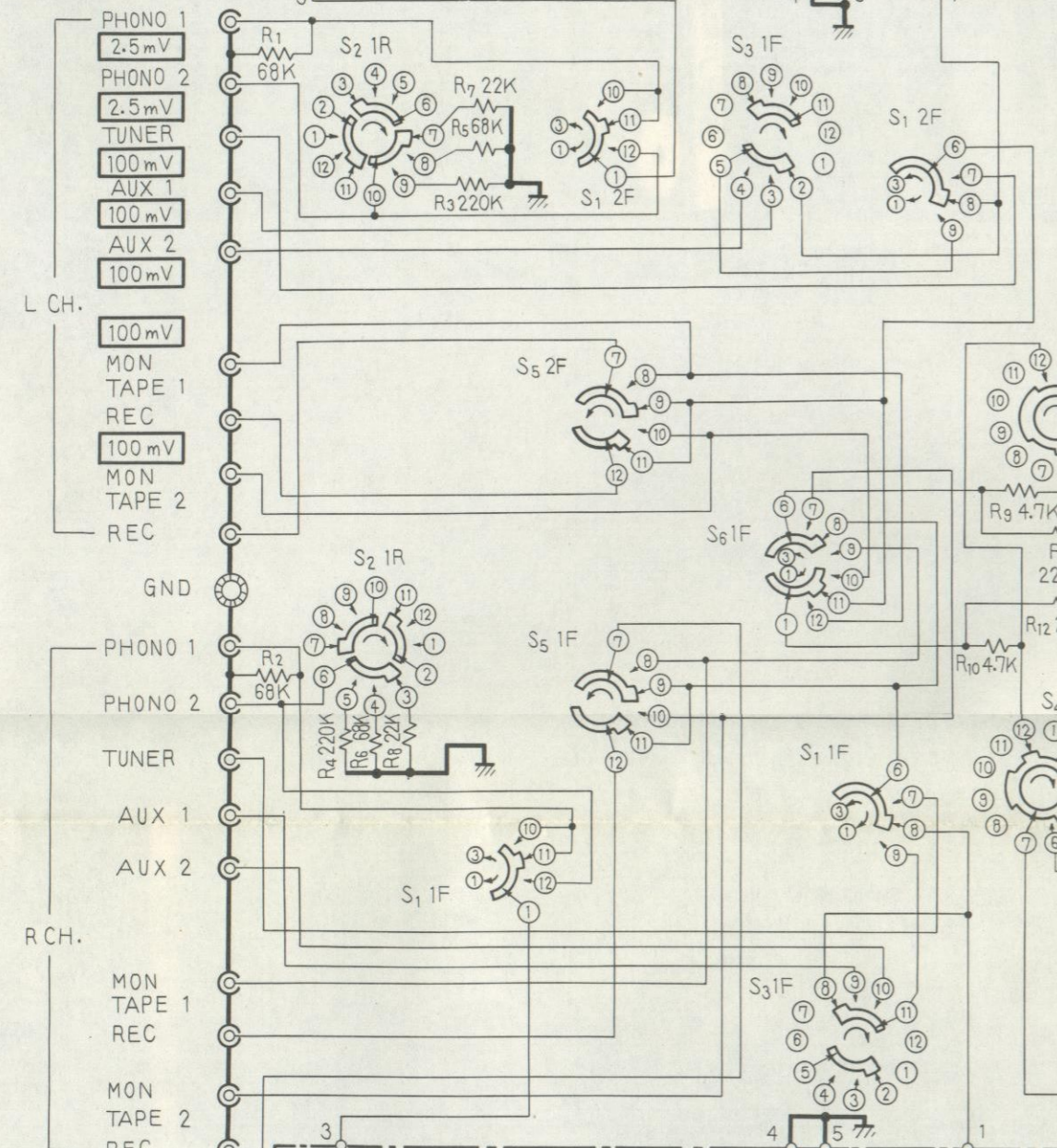
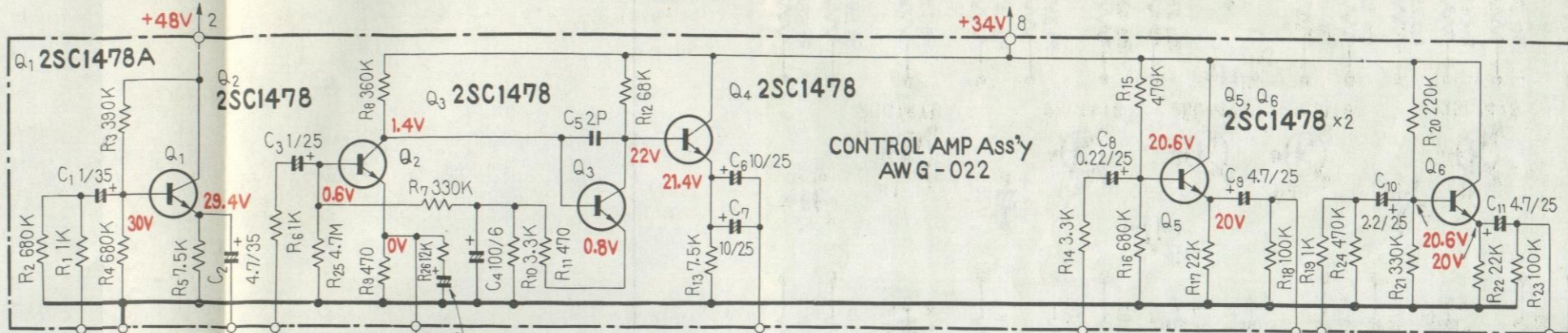

EQUALIZER AMP ASS'Y AWF-009

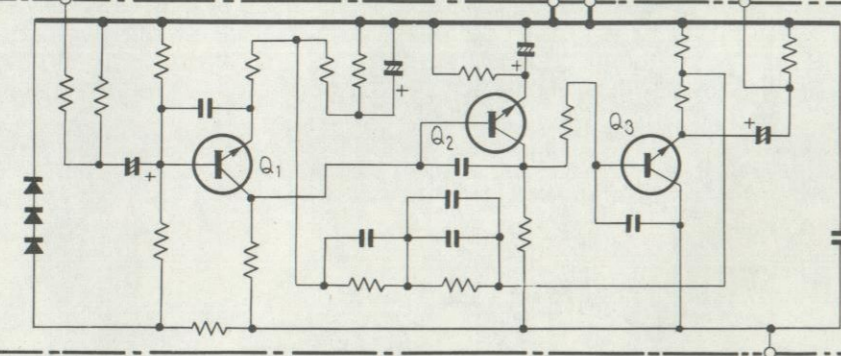

CONTROL AMP ASS'Y AWG-022

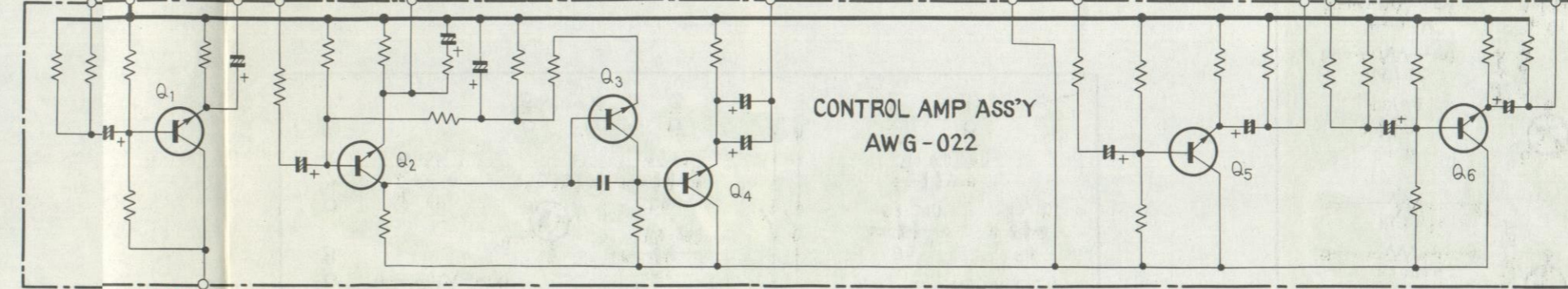

- SWITCHES**
- S1: FUNCTION-LEVER (PHONO 1 position)
 - FUNCTION-ROTARY
 - PHONO 1
 - TUNER
 - S2: PHONO 2 INPUT IMPEDANCE (20K position)
 - 20K
 - 50K
 - 100K
 - S3: FUNCTION-ROTARY (PHONO 2 position)
 - PHONO 2
 - AUX 1
 - AUX 2
 - S4: MODE (STEREO REV. position)
 - STEREO REV.
 - STEREO NORM.
 - MONO L+R
 - MONO L
 - MONO R
 - S5: DUPLICATE (OFF position)
 - OFF
 - ON
- S6: TAPE MONITOR (SOURCE position)**
- 1
 - SOURCE
 - 2
- S7: ATTENUATOR (-15dB position)**
- 0dB
 - 15dB
 - 30dB
- S8: TREBLE CONTROL LEFT (-12.5dB position)**
-12.5dB ~ +12.5dB (2.5dB step at 10kHz)
- S9: TREBLE CONTROL RIGHT (-12.5dB position)**
-12.5dB ~ +12.5dB (2.5dB step at 10kHz)
- S10: BASS CONTROL LEFT (-10dB position)**
-10dB ~ +15dB (2.5dB step at 50Hz)
- S11: BASS CONTROL RIGHT (-10dB position)**
-10dB ~ +15dB (2.5dB step at 50Hz)
- S12: HIGH FILTER (OFF position)**
- 12kHz
 - OFF
 - 8kHz
- S13: LOW FILTER (OFF position)**
- SUBSONIC
 - OFF
 - 30Hz

- POTENTIOMETERS**
- VR1: VOLUME 0 ~ -60dB, ∞
 - VR2: BALANCE
- AC 220/240V 50 ~ 60Hz**
- UNSWITCHED AC OUTLETS**
- SWITCHED AC OUTLETS**
- RESISTORS**
- IN OHM, 1/4W, ±5% TOLERANCE UNLESS OTHERWISE NOTED.
- K: kΩ N: MΩ
- V**: DC VOLTAGE AT NO INPUT SIGNAL.
- A**: DC CURRENT AT NO INPUT SIGNAL.
- V**: SIGNAL VOLTAGE NECESSARY FOR OBTAINING 2V OUTPUT (1kHz)

POWER SUPPLY CIRCUIT Ass'y AWR-037

