

Operating Instructions

FM/AM DIGITAL SYNTHESIZED TUNER F-90



Thank you for buying this Pioneer product. Please read through these operating instructions and then you will know how to operate your model properly. After you have finished reading the instructions, put them away in a safe place for future reference.

These operating instructions are based on the model HE, and they can be used for the HB, YP, KU, KC, S, SS, S/G models. The differences between the models are given below.

HE model:

For Europe ('HE' stamped on packing case): power line voltage is a.c. 220 volts ~.

HB model:

For U.K. ('HB' stamped on packing case): power line voltage is a.c. 240 volts ~.

YP model:

For Australia ('YP' stamped on packing case): power line voltage is a.c. 240 volts ~.

KU and KC models:

For U.S.A.(KU) and Canada(KC) ('KU' or 'KC' stamped on packing case): power line voltage is AC 120 volts.

S, S/G and SS models:

For destinations excluding above ('S' 'S/G' or 'SS' stamped on packing case); A 4-point (AC 110/120/220/240 V) voltage selector switch is provided.

IMPORTANCE NOTICE (KU model only)

The serial number for this equipment is located on the rear panel. Please write this serial number on your enclosed warranty card and keep in a secure area. This is for your security.

KU (for U.S.A.) and KC (for Canada) models are not provided with LINE VOLTAGE SELECTOR switch.

LINE VOLTAGE SELECTOR SWITCH

[Only S, SS and S/G models are provided with this switch, but KU, KC and other models (HE, HB, YP) are not provided with this switch.]

Check that the indication of the switch is same as your residence area before plugging the power cord into the outlet. If it isn't or if you move to an area where the voltage requirements differ, change the switch setting as follows. Before adjusting, disconnect the power cord.

1. Prepare a medium size screwdriver.
2. Insert the screwdriver into the groove of the selector switch and turn it so that the power voltage marking of your area points to the white mark.

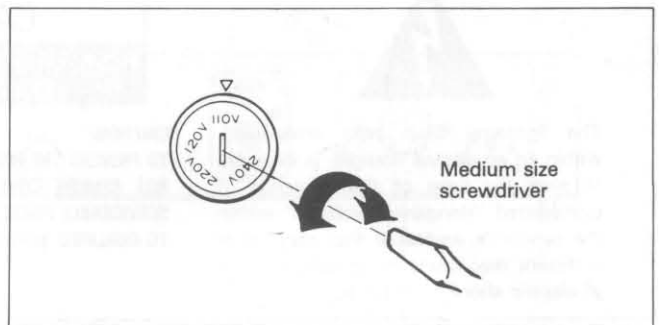

WARNING: TO PREVENT FIRE OR SHOCK HAZARD, DO NOT EXPOSE THIS APPLIANCE TO RAIN OR MOISTURE.

CONTENTS

| | | | |
|----------------------------------|---|-----------------------------------|----|
| Rear Panel Facilities | 3 | Automatic and manual tuning | 10 |
| Features | 4 | Presetting stations | 11 |
| Connections | 5 | Troubleshooting | 12 |
| Hints for better reception | 7 | Specifications | 13 |
| Front panel facilities | 8 | Station Call Code Memo | 14 |

SAFETY INSTRUCTIONS

READ INSTRUCTIONS — All the safety and operating instructions should be read before the appliance is operated.

RETAIN INSTRUCTIONS — The operating instructions should be retained for future reference.

HEED WARNING — All warnings on the appliance and in the operating instructions should be adhered to.

FOLLOW INSTRUCTIONS — All operating and use instructions should be followed.

WATER AND MOISTURE — The appliance should not be used near water — for example, near a bathtub, washbowl, kitchen sink, laundry tub, in a wet basement, or near a swimming pool, etc.

LOCATION — The appliance should be installed in a stable location.

WALL OR CEILING MOUNTING — The appliance should not be mounted to a wall or ceiling.

VENTILATION — The appliance should be situated so that its location or position does not interfere with its proper ventilation. For example, the appliance should not be situated on a bed, sofa, rug, or similar surface that may block the ventilation openings; or, placed in a built-in installation, such as a bookcase or cabinet that may impede the flow of air through the ventilation openings.

HEAT — The appliance should be situated away from heat sources such as radiators, heat registers, stoves, or other appliances (including amplifiers) that produce heat.

POWER SOURCES — The appliance should be connected to a power supply only of the type described in the operating instructions or as marked on the appliance.

POWER-CORD PROTECTION — Power-supply cords should be routed so that they are not likely to be walked on or pinched by items placed upon or against them, paying particular attention to cords at plugs, convenience receptacles, and the point where they exit from the appliance.

CLEANING — The appliance should be cleaned only with a polishing cloth or a soft dry cloth. Never clean with furniture wax, benzene, insecticides or other volatile liquids since they may corrode the cabinet.

POWER LINES — An outdoor antenna should be located away from power lines.

NONUSE PERIODS — The power cord of the appliance should be unplugged from the outlet when left unused for a long period of time.

OBJECT AND LIQUID ENTRY — Care should be taken so that objects do not fall and liquids are not spilled into the enclosure through openings.

DAMAGE REQUIRING SERVICE — The appliance should be serviced by Pioneer authorized service center or qualified service personnel when:

- The power-supply cord or the plug has been damaged; or
- Objects have fallen, or liquid has been spilled into the appliance; or
- The appliance has been exposed to rain; or
- The appliance does not appear to operate normally or exhibits a marked change in performance; or
- The appliance has been dropped; or the enclosure damaged.

SERVICING — The user should not attempt to service the appliance beyond that described in the operating instructions. For all other servicing, contact the nearest Pioneer authorized service center.

OUTDOOR ANTENNA GROUNDING — If an outside antenna is connected to the antenna terminal, be sure the antenna system is grounded so as to provide some protection against voltage surges and built up static charges.

In the U.S.A. section 810 of the National Electrical Code, ANSI/NEPA No. 70-1981, provides information with respect to proper grounding of the mast and supporting structure, grounding of the lead-in wire to an antenna discharge unit, size of grounding conductors, location of antenna-discharge unit, connection to grounding electrodes, and requirements for the grounding electrode. See Fig. A.

EXAMPLE OF ANTENNA GROUNDING AS PER NATIONAL ELECTRICAL CODE INSTRUCTIONS

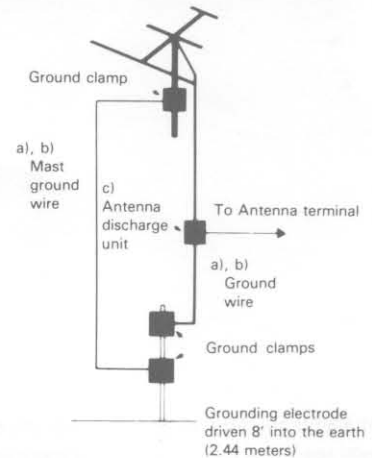

Fig. A

- a) Use No. 10 AWG (5.3 mm²) copper or No. 8 AWG (8.4 mm²) aluminum or No. 17 AWG (1.0 mm²) copper-clad steel or bronze wire, or larger as ground wires for both mast and lead-in.
- b) Secure lead-in wire from antenna to antenna discharge unit and mast ground wire to house with stand-off insulators, spaced from 4 feet (1.22 meters) to 6 feet (1.83 meters) apart.
- c) Mount antenna discharge unit as closely as possible to where lead-in enters house.

IMPORTANT



The lightning flash with arrowhead, within an equilateral triangle, is intended to alert the user of the presence of uninsulated "dangerous voltage" within the product's enclosure that may be of sufficient magnitude to constitute a risk of electric shock to persons.

CAUTION

**RISK OF ELECTRIC SHOCK
DO NOT OPEN**

CAUTION:
TO PREVENT THE RISK OF ELECTRIC SHOCK, DO NOT REMOVE COVER (OR BACK). NO USER-SERVICEABLE PARTS INSIDE. REFER SERVICING TO QUALIFIED SERVICE PERSONNEL.



The exclamation point within an equilateral triangle is intended to alert the user of the presence of important operating and maintenance (servicing) instructions in the literature accompanying the appliance.

IMPORTANT

To prevent electric shock, do not remove cover. No user serviceable parts inside, refer servicing to qualified service personnel. Always disconnect all the equipment from the mains supply when disconnecting the signal leads. The power cord should be connected last, make sure that the power switch is off. Unplug the set from the wall socket when it is not to be used for an extended period of time.

FOR USE IN UNITED KINGDOM AND AUSTRALIA

CAUTION 240 V: Mains supply voltage is factory adjusted at 240 V.

FOR USE IN UNITED KINGDOM

The wires in this mains lead are coloured in accordance with the following code:

| | |
|--------|---------|
| Blue: | Neutral |
| Brown: | Live |

As the colours of the wires in the mains lead of this apparatus may not correspond with the coloured marking identifying the terminals in your plug proceed as follows:

The wire which is coloured blue must be connected to the terminal which is marked with the letter N or coloured black.

The wire which is coloured brown must be connected to the terminal which is marked with the letter L or coloured red.

Equipment sold in the U.K. is not supplied with a power plug.

REAR PANEL FACILITIES

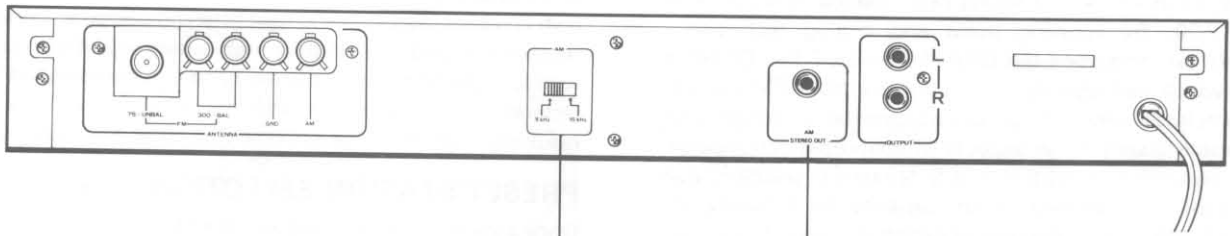

AM CHANNEL STEP SWITCH (KU model only)

Before the tuner leaves the manufacturing plant, this switch is set to the channel allotment plan of the tuner's destination. For the U.S.A., it is set to 10 kHz. Check that the switch is set properly before use.

If the switch is set to the wrong position, figures on the frequency display will not stop with AM tuning.

NOTE:

Contact your dealer and inquire if you are not sure about the channel allotment plan.

AM STEREO OUTPUT JACK (KU model only)

This jack is for AM stereo broadcasts. When listening to the AM stereo broadcasts, connect the adaptor component to this jack. For further details, refer to the operating instructions of the AM stereo adaptor component.

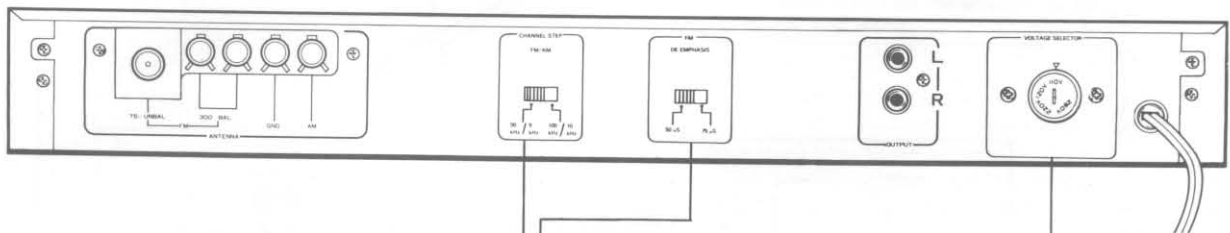

FM DE-EMPHASIS SWITCH (S, S/G and SS models only)

This switch is used to select the de-emphasis value. Before the tuner leaves the manufacturing plant, it is set to the de-emphasis of the tuner's destination. For the United States and Canada, it is set 75 μ s, and for other countries to 50 μ s. Check that the switch is set properly before use. If the switch is set to the wrong position, the high-frequency range sound will appear distorted during the reception of an FM broadcast. Contact your dealer and inquire if you are not sure about the de-emphasis in your area.

FM/AM CHANNEL STEP SWITCH (S, S/G and SS models only)

Before the tuner leaves the manufacturing plant, this switch is set to the channel allotment plan of the tuner's destination. Check that the switch is set properly before use.

If the switch is set to the wrong position, figures on the frequency display will not stop with FM or AM tuning.

NOTE:

Contact your dealer and inquire if you are not sure about the channel allotment plan.

LINE VOLTAGE SELECTOR SWITCH (S, S/G and SS models only)

Refer to the front page about switching LINE VOLTAGE.

FEATURES

DIGITAL DIRECT DECODER

The DECODER CIRCUIT is a vital part of the tuner. Its function is to control tone and sound performance. It is the heart of the F-90. By applying pulse and analog technology, PIONEER has developed the DIGITAL DIRECT DECODER, a system which can decode stereo directly from FM signals. This completely new system is instrumental in bringing an unbelievable quality to all aspects of sound performance including separation, distortion and S/N ratio. In addition, due to a major improvement in its capacity to eliminate interference, this tuner is capable of extremely clean, fine reception.

AUTO SEARCH

An electronic tuning circuit inside the unit searches for the station automatically for greatly simplified station selection.

REFERENCE SIGNAL OSCILLATOR FOR SUPERB FM RECORDING

When the REC LEVEL CHECK (Recording Level Check Switch) is ON during FM recording, the OUTPUT Terminal emits a Reference Signal (Frequency about :330 Hz Level :FM 50% modulation) which sets the recording level of the tape deck to achieve optimum recording conditions.

PUSH-BUTTON SELECTION OF IF-BAND FOR WIDE OR NARROW BAND RECEPTION

All it takes is a push of a button to select the IF-band that will give you best reception and best listening pleasure. Wide band reception is recommended for high quality sound reproduction with low distortion, and narrow band is recommended for interference free reception and the elimination of jamming resulting from the close proximity of other FM stations.

PRESET STATION SELECTION

Once a station has been fed into the Memory, no manual tuning is necessary. It can be selected at the touch of a switch.

CONNECTIONS

CONNECT THE ANTENNA IN ALL CASES

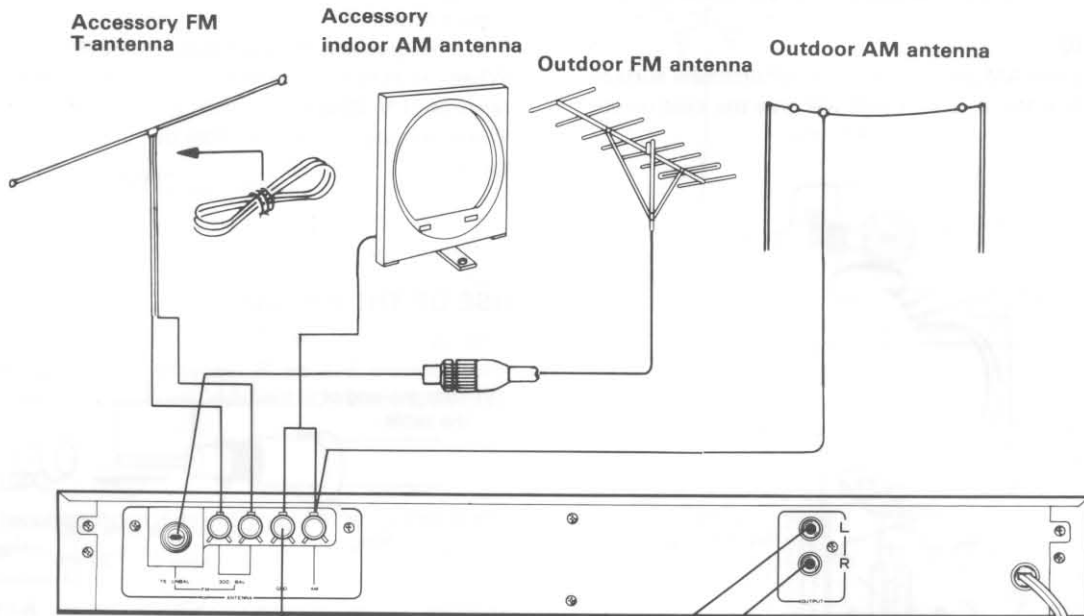

Pin plug connecting cord

- Connect the white plug to the white terminal (L) and the red plug to the red terminal (R.)
- Make sure that there is a proper connection.

Connecting power cord

Plug the POWER CORD into the auxiliary power outlet on the amplifier or into an AC wall socket.

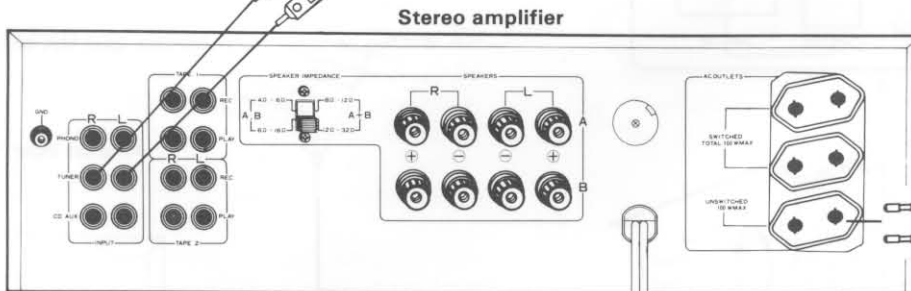

AC wall socket

Antenna ground

Although grounding is not necessary for reception it is recommended for prevention of static.

NOTE:

Never make the ground connection to a gas pipe as sparks could cause the gas to ignite.

Illustration is applicable to HE model. HB (for U.K.) model is not provided with power plug.

AM LOOP ANTENNA INSTALLATION

Connect the AM loop antenna and position it so that it does not come into contact with the unit or with any metal objects.

Free standing

When standing the AM loop antenna on a horizontal surface position, face it in the direction that will give the best reception.

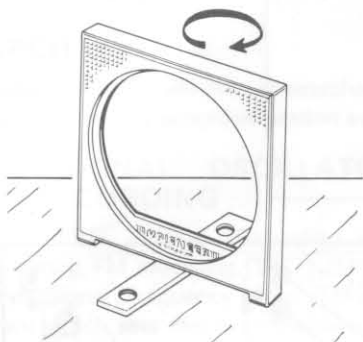

Mounting

When mounting the AM loop antenna to a wall or vertical surface, secure it with wood screws or thumbtacks then rotate it so that it is facing the direction that will give the best reception.

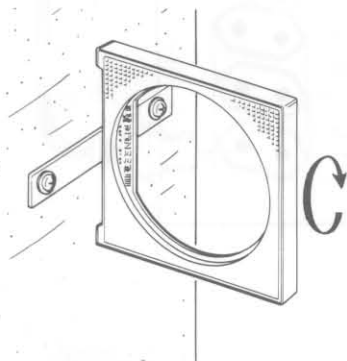

AM Loop Antenna
Can be fixed to a wall using wood screws.

CONNECTING THE COAXIAL CABLE (For KU, KC, YP, S, SS and S/G models only)

Connect the coaxial cable as shown in the diagram using the F-plug provided.

The F-plug uses a coaxial cable (RG-59U).

When the plug has been fitted, connect it to the antenna input terminal (FM 75-ohms UNBAL) used with the coaxial cable. When connecting up the cable be careful not to bend or fold the wire.

USE OF THE F-PLUG

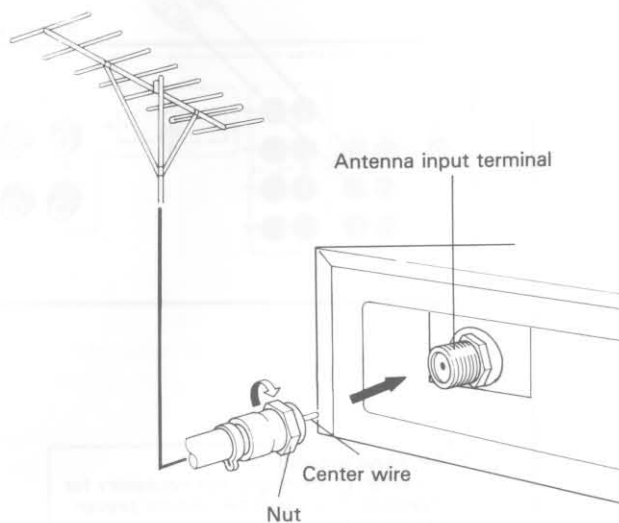
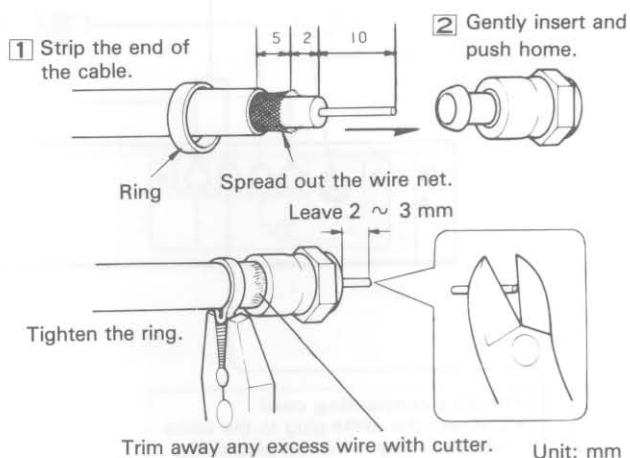

- Insert the center wire taking care not to bend it.
- Tighten the nut of the F-Plug by turning it in a clockwise direction.

HINTS FOR BETTER RECEPTION

ANTENNA INSTALLATION

If FM reception is still poor even with the accessory T-type antenna, it means that the signals in your area are not being picked up satisfactorily and that an outdoor antenna should be erected.

NOTE:

Consult your dealer as to the selection and actual installation of the FM antenna.

FM ANTENNA CONNECTIONS

There are two ways of connecting the FM antenna to the antenna input terminals: with a 300-ohm twin-lead feeder or with a 75-ohm coaxial cable. If full justice is to be done to the tuner's performance, a 75-ohm coaxial cable is recommended since it is more immune than the twin-lead feeder to noise and interference from external sources. If an FM antenna has already been erected outdoors, connect it, referring to the figure.

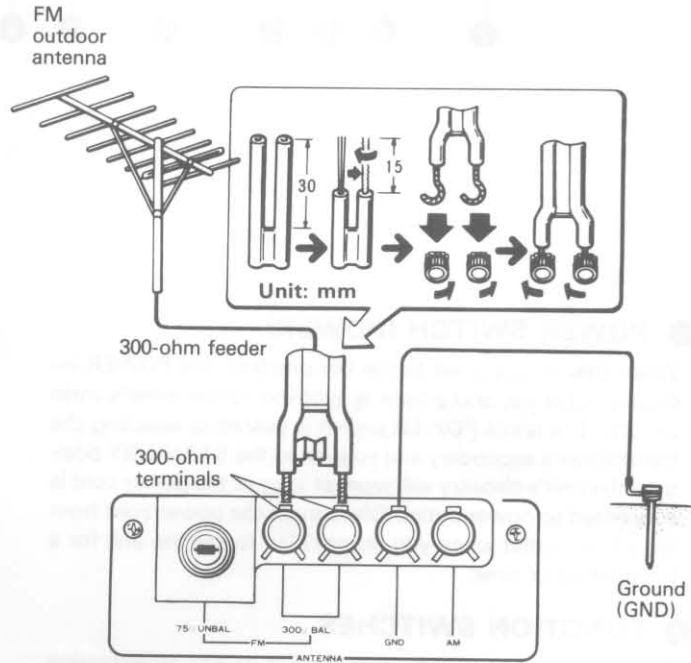
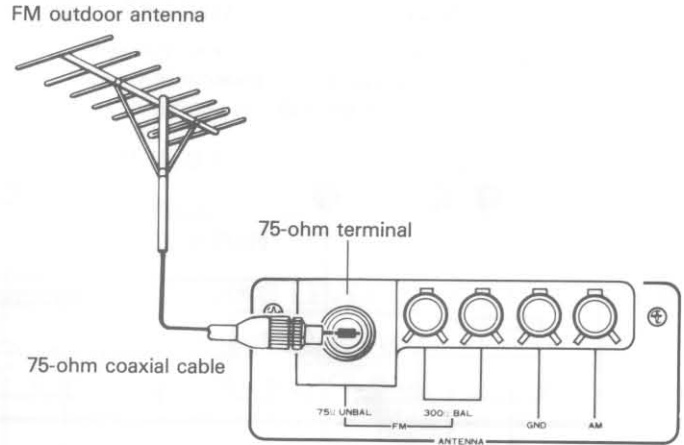

GROUNDING

Grounding is recommended if reception of FM programs is impaired by noise. To ground, connect a thick polyvinyl insulated wire to the GND terminal and attach the other end to a metal water pipe or grounding bar or wind it around a copper plate and bury it.

NOTE:

Never connect a wire to a gas pipe for grounding since sparks may ignite the gas.

OUTDOOR AM ANTENNAS

The accessory AM loop antenna is quite sufficient if you live in a strong-signal area. However, an outdoor AM antenna should be erected if surrounding objects are interfering with reception or if the stations are distant and their signals are weak.

NOTE:

Do not detach the AM loop antenna when using an outdoor AM antenna.

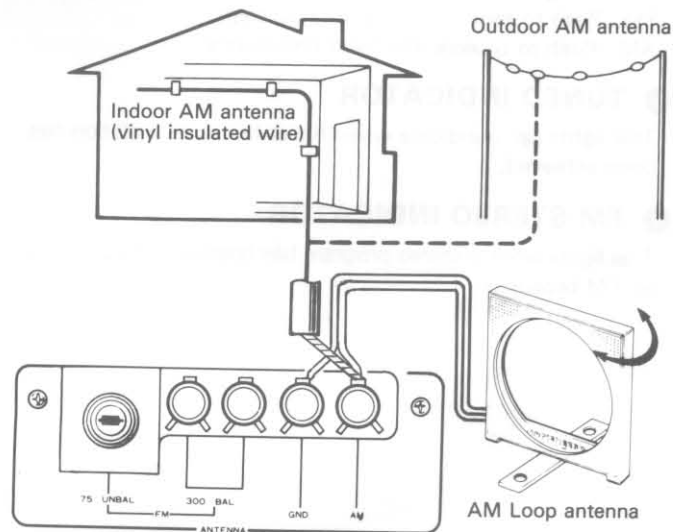

FRONT PANEL FACILITIES

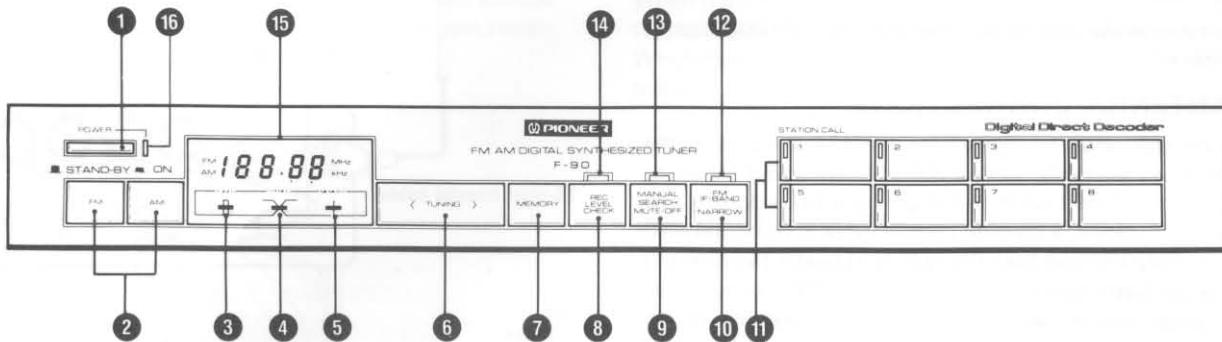

1 POWER SWITCH (POWER)

When this switch is set to the ON position, the POWER indicator lights up, and power is supplied to the tuner's main circuits. The unit's POWER switch is geared to selecting the transformer's secondary and so even at the STAND-BY position, the unit's circuitry will work as long as the power cord is connected to power outlet. Disconnect the power cord from the power outlet when you do not plan to use the unit for a long period of time.

2 FUNCTION SWITCHES

These are used to select either the FM or AM broadcasting bands. The frequency indicating portion of the display will also change.

FM: Push to receive FM band broadcasts.

AM: Push to receive AM band broadcasts.

3 TUNED INDICATOR

This lights up to indicate when finest tuning of a station has been achieved.

4 FM STEREO INDICATOR

This lights when a stereo program has been picked up during an FM broadcast.

5 MEMORY INDICATOR

This lights up when the MEMORY switch is depressed.

6 TUNING SWITCHES

These are used to locate stations. Push the left half of this switch "<" to locate a station broadcasting on a lower frequency and the right half of this switch ">" to locate a station broadcasting on a higher frequency.

7 MEMORY SWITCH

This is used to memorize stations. Once a station has been memorized using the STATION CALL switches, all that is necessary to recall the station of your choice is to press the appropriate STATION CALL switch. The MEMORY completely does away with the need for manual tuning when selecting your favorite stations.

8 RECORDING LEVEL CHECK SWITCH (REC LEVEL CHECK)

Press this switch to check the recording level when recording FM broadcasts on tape.

When the REC LEVEL CHECK switch is pressed (ON), the REC LEVEL CHECK indicator will light up and FM recording reference level signals of about 330 Hz, FM 50% modulation or equivalent will be emitted from the OUTPUT terminals. (The same signals are emitted in case of recording AM broadcasts.) Adjust the recording level of the tape deck when it is in recording mode. For the cassette tape deck set the LEVEL METER indicator to 0~ +2 dB.

When the RECORDING LEVEL CHECK is completed, return the switch to the OFF position. (The indicator goes off.) If this switch is left in the ON position, a "beep" sound will occur and the broadcasts cannot be received.

9 MANUAL SEARCH MUTE-OFF SWITCH

This is the switch that allows you to choose between AUTO SEARCH and MANUAL tuning. FM MUTING functions when the AUTO SEARCH is in use, but does not function during MANUAL tuning. The indicator lights up during MANUAL tuning. The purpose of FM MUTING is to eliminate static occurring between FM stations. However, reception of your desired station may sometimes not be possible when receiving over long distances or when signals are weak if the FM MUTING switch is in the ON position. In such cases, cancel FM MUTING and select the desired station manually. When the FM MUTING switch is in the OFF position, it will only be possible to receive in MONO not in STEREO. It is recommended that you leave the FM MUTING switch ON for your normal listening enjoyment, especially when receiving from stations with weak input signals. MUTING only works for FM broadcasts. The position of this switch will not affect AM broadcasts.

10 FM IF-BAND SWITCH

This switch makes it possible to change passing bands for signals of intermediate frequencies during FM broadcasts. Press once for NARROW BAND reception. The FM IF indicator will light up. Press again for WIDE BAND reception and the indicator will go out.

NARROW BAND:

If there are other stations located near the station of your choice, you may find you are receiving interference from them and reception is poor. In such a case, turn on to NARROW BAND to effectively eliminate any interference.

WIDE BAND:

If there are no other stations located near the station of your choice and you are in a good area for reception, turn on to WIDE BAND for high-quality tone and superb reception.

11 STATION CALL SWITCHES

These are used to preset and recall broadcasting stations thereby eliminating the necessity of using the TUNING switches to locate your favorite stations.

12 FM IF-BAND NARROW INDICATOR

13 MANUAL SEARCH MUTE-OFF INDICATOR

14 RECORDING LEVEL CHECK INDICATOR

15 FREQUENCY DISPLAY

This shows the frequency of the station currently being received in digital form. The FM band is indicated by MHz, and the AM band is by kHz.

16 POWER INDICATOR

AUTOMATIC AND MANUAL TUNING

- Check that all terminals are properly connected before switching on the unit.
- Before starting to use the unit, turn the FUNCTION switch on the stereo amplifier to TUNER.

- The REC LEVEL CHECK switch and the FM MUTING switch should be set to their protruding positions.

AUTO SEARCH

The electronic tuning circuit inside the unit will search for your desired station automatically.

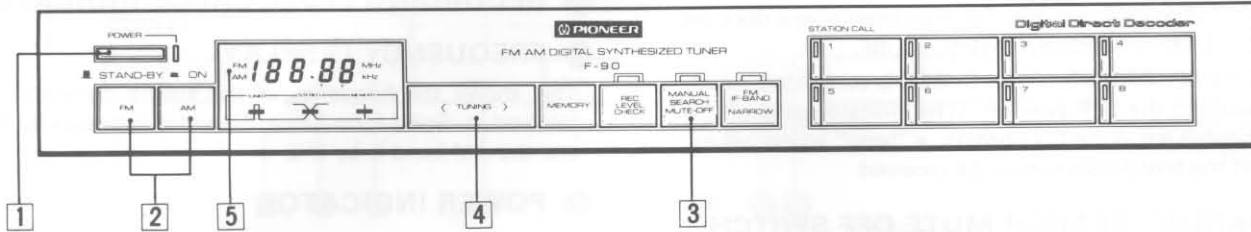

- 1 Turn on the **POWER** of the unit and the stereo amplifier.
- 2 Select your desired broadcasting band using the **FM/AM FUNCTION** switches.
- 3 Check that the **MANUAL SEARCH** switch is **OFF**. (The upper indicator is **OFF**.)
- 4 Press the **TUNING** switches "<" or ">" for a higher or lower frequency as desired.

- 5 The frequency will change rapidly during scanning. The **AUTO SEARCH** will stop automatically when the desired station is located and the **TUNED** indicator will light up.

NOTE:

When the **AUTO SEARCH** is in use, reception may not be possible over long distances or when signals are weak. At these times manual tuning is recommended.

MANUAL TUNING

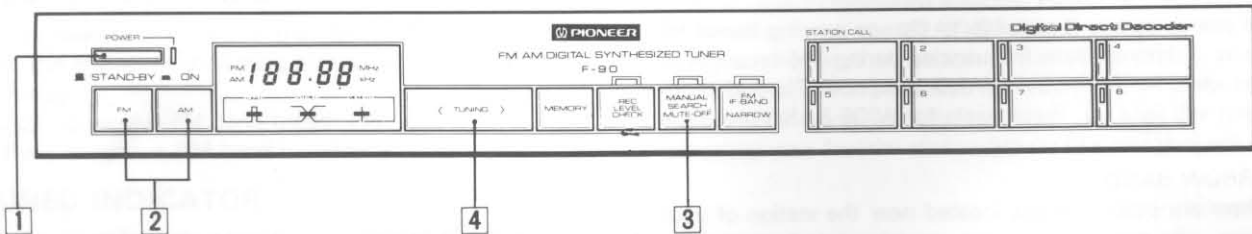

- 1 Turn on the **POWER** of the unit and the stereo amplifier.
- 2 Select your desired broadcasting band using the **FM/AM FUNCTION** switches.
- 3 Press the **MANUAL SEARCH** switch (The upper indicator light up).

- 4 Use the **TUNING** switches to locate the frequency of your desired station.

For step-by-step searching, press the **TUNING** switch once and release it immediately. For continuous rapid scanning keep the **TUNING** switch pressed. The **TUNED** indicator will light up when the desired station is tuned in best.

NOTE:

The **TUNED** indicator will not function for broadcasts received over long distances or when signals are weak. When **FM** broadcast is received in **MANUAL TUNING**, muting will not operate and **FM** stereo broadcast will be received in mono.

PRESETTING STATIONS

This unit is fitted with a presetting function for memorizing stations independently on both FM and AM bands. Once the stations have been preset, all you have to do to recall them is push the STATION CALL switches. A total of 16 stations can be preset, a maximum of 8 for each band.

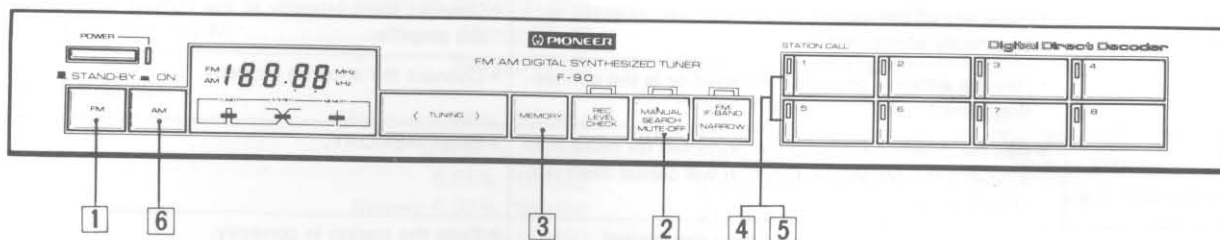

1 Presetting FM Stations

- Press the FM FUNCTION switch.

2 Begin receiving.

- For AUTO SEARCH tuning refer to "AUTO SEARCH".
- For MANUAL tuning refer to "MANUAL TUNING".

3 When fine tuning has been completed, press the MEMORY switch to memorize your desired station.

- The MEMORY indicator will light up.

4 Press the STATION CALL switch.

- Press this switch while the MEMORY indicator is still lit.
- When the station has been memorized, the STATION CALL indicator will light up.
- If the MEMORY indicator fails to light up it means that your desired station has not been memorized. In this case repeat Steps 3 — 4 again.

5 Repeat steps 2 through 4 to preset stations.

- A maximum of 8 stations can be preset using the MEMORY function.

6 Presetting AM Stations

- Press the AM FUNCTION switch. Then proceed as you would for FM station presetting following steps 3 through 4 above. A maximum of 8 stations can be preset using the MEMORY function.

At completion of memorization

Once you have completed memorizing your desired stations set the FUNCTION switch to the desired band and push the desired STATION CALL switch to begin receiving the broadcasts.

CHECKING THE MEMORY

Check that all your desired stations are correctly memorized by pressing STATION CALL switches 1 through 8 in turn. For quick and easy reference record each station name and STATION CALL NUMBER in the handy STATION CALL CODE MEMO on page 14.

NOTES:

- Preset stations will be retained in the MEMORY when the POWER is switched OFF as long as the POWER cord is not disconnected.
- It is recommended that you disconnect the POWER cord when the unit is not being used for long periods of time. The electrical circuit controlling the MEMORY function is powered by a BACK-UP CONDENSER so that the unit will retain preset stations for a period of up to 3 days.
- If a preset station has been erased, reset it.

INSTANT RECALL FUNCTION

- The last station received before the POWER was turned OFF will be instantly recalled when the POWER is turned ON again.
- When switching between FM and AM bands while the unit is "ON", there will be instant recall of the last station received on that band.

TROUBLESHOOTING

If you think your unit is malfunctioning, take the time to check out the points below. In many cases, carelessness or incorrect operation is to blame. Alternatively, the problem may lie outside the unit. Make a point of checking the other stereo components being used as well as any other electrical appliances. If the trouble is not remedied even after checking the points below, contact your nearest PIONEER Service Center or your dealer.

| Symptom | Trouble | Remedy |
|--|--|--|
| No power (POWER switch at ON) | <ul style="list-style-type: none"> • Has the power cord been disconnected? | <ul style="list-style-type: none"> • Reconnect the power cord. |
| No sound | <ul style="list-style-type: none"> • Have any of the output cords been disconnected or incorrectly connected? | <ul style="list-style-type: none"> • Connect them properly to the TUNER terminals on the amplifier. |
| | <ul style="list-style-type: none"> • Has the antenna been disconnected or is the connection loose? | <ul style="list-style-type: none"> • Connect the antenna properly. |
| | <ul style="list-style-type: none"> • Has the power cord been disconnected for more than 3 days? (The MEMORY function will cancel itself out after 3 days.) | <ul style="list-style-type: none"> • Reset MEMORY. |
| Static | <ul style="list-style-type: none"> • Is the station properly tuned in to the correct frequency? | <ul style="list-style-type: none"> • Tune the station in correctly. |
| | <ul style="list-style-type: none"> • Has the antenna been disconnected or is the connection loose? | <ul style="list-style-type: none"> • Connect the antenna properly. |
| Sound distortion | <p>On the FM band</p> <ul style="list-style-type: none"> • Is the cord of the T-antenna still folded up and not extended or is the antenna facing in the wrong direction? | <ul style="list-style-type: none"> • Change the direction of the antenna until best reception is obtained. |
| | <ul style="list-style-type: none"> • Are the signals weak and reception poor? | <ul style="list-style-type: none"> • Receive broadcast in MANUAL TUNING. (Broadcast can be received in MONO.) • Substitute an FM outdoor antenna for the FM T-antenna. |
| | <ul style="list-style-type: none"> • Static from other appliances (particularly automobiles) or multipath reflection (radio waves beamed off mountains and tall buildings and not received direct.) | <ul style="list-style-type: none"> • Try varying the height and direction of the antenna or use an FM outdoor antenna substituting a 75-ohm coaxial cable for the standard cable and fixing it as far away as possible from the street. |
| | <p>On the AM band</p> <ul style="list-style-type: none"> • Poor positioning of AM loop antenna? | <ul style="list-style-type: none"> • Change the direction of the antenna until best reception is obtained. |
| | <ul style="list-style-type: none"> • Are the signals weak and reception poor? | <ul style="list-style-type: none"> • Fix an AM outdoor antenna or ground the antenna. |
| | <ul style="list-style-type: none"> • Static from other electrical appliances (fluorescent lights /motors?) | <ul style="list-style-type: none"> • Switch off other appliances or use as far away as possible from the tuner when in use. |
| FM Stereo broadcasts not received in stereo | <ul style="list-style-type: none"> • Is the MANUAL SEARCH indicator light up? | <ul style="list-style-type: none"> • MANUAL SEARCH indicator turn off. |

Caution with Auto-Search:

- Since this is a highly sensitive mechanism, the frequency search operation may stop even with weak foreign broadcasts, particularly at night. Also, frequency noise in large cities may also cause the search operation to stop.
- When using Auto-Search to present AM station, if the frequency search operation stops too frequently, changing the position of

- the AM loop antenna may be of help in reducing its sensitivity so that only powerful, nearby stations are received. After tuning in the station, be sure to reposition the antenna to its best position for reception.
- For very weak station, use the manual tuning mode to preset station.

SPECIFICATION

MEMO

FM Tuner Section

| | |
|-------------------------------|--|
| Frequency range | 88 MHz to 108 MHz |
| Usable Sensitivity | 10.8 dBf, IHF (0.95 μ V/75 Ω) |
| 50 dB Quieting Sensitivity | Mono; 16.2 dBf, IHF (1.8 μ V/75 Ω) Stereo; 37.7 dBf, IHF (21.0 μ V/75 Ω) |
| Sensitivity (DIN) | Mono; 0.75 μ V/75 Ω Stereo; 22.0 μ V/75 Ω |
| Signal-to-Noise Ratio | Mono; 93 dB (at 80 dBf) Stereo; 86 dB (at 80 dBf) |
| Signal-to-Noise Ratio (DIN) | Mono; 83 dB Stereo; 77 dB |
| Distortion (at 80 dBf) | |
| WIDE | Mono; 0.0095% (100 Hz) 0.0095% (1 kHz) 0.01% (10 kHz) Stereo; 0.02% (100 Hz) 0.02% (1 kHz) 0.07% (10 kHz) |
| NARROW | Mono; 0.09% (1 kHz) Stereo; 0.5% (1 kHz) |
| Capture Ratio | 0.8 dB (WIDE) |
| Alternate Channel Selectivity | 85 dB (400 kHz) (NARROW) |
| Stereo Separation | |
| WIDE | 65 dB (1 kHz) 50 dB (20 Hz to 10 kHz) |
| NARROW | 40 dB (20 Hz to 10 kHz) |
| Frequency Response | 20 Hz to 15 KHz \pm 0 ; $\frac{2}{8}$ dB |
| Muting Threshold | 25.2 dBf (5 μ V/75 Ω) |
| Antenna Input | 300 Ω balanced 75 Ω unbalanced |

AM Tuner Section

| | |
|---------------------------------|----------------------|
| Frequency range | 530 kHz to 1,600 kHz |
| Sensitivity (IHF, Loop antenna) | 150 μ V/m |
| Signal-to-Noise Ratio | 50 dB |
| Antenna | Loop Antenna |

Audio Section

| | |
|--------------------------|---------------------|
| Output (Level/Impedance) | |
| FM (100% MOD) FIXED | 650 mV/900 Ω |
| AM (30% MOD) FIXED | 150 mV/900 Ω |

Miscellaneous

Power Requirements

| | |
|----------------------|--|
| HE model | a.c. 220 Volts \sim , 50/60 Hz |
| HB model | a.c. 240 Volts \sim , 50/60 Hz |
| YP model | a.c. 240 Volts \sim , 50 Hz |
| KU and KC models | AC 120 V, 60 Hz |
| S, SS and S/G models | AC 110/120/220/240 V (switchable) 50/60 Hz |

Power Consumption

| | |
|----------------------|------|
| HE model | 14 W |
| HB model | 14 W |
| YP model | 14 W |
| KU and KC models | 14 W |
| S, SS and S/G models | 14 W |

| | |
|------------|--|
| Dimensions | 420(W) x 61(H) x 317(D) mm 16-9/16(W) x 2-3/8(H) x 12-1/2(D) in |
|------------|--|

| | |
|--------------------------|--------------------|
| Weight (without package) | 4.5 kg(9 lb 15 oz) |
|--------------------------|--------------------|

Furnished Parts

| | |
|---|---|
| FM T-type Antenna | 1 |
| AM Loop Antenna | 1 |
| Connection Cord with Pin Plugs | 1 |
| F-type plug (except HE, HB and YP models) | 1 |
| Operating Instructions | 1 |

NOTE:

Specifications and design subject to possible modification without notice.

STATION CALL CODE MEMO

STATION CALL CODE MEMO

| STATION CALL switch | 1 | 2 | 3 | 4 | 5 | 6 | 7 | 8 |
|------------------------|-----|-----|-----|-----|-----|-----|-----|-----|
| FM Station | | | | | | | | |
| Broadcasting frequency | MHz | MHz | MHz | MHz | MHz | MHz | MHz | MHz |
| AM Station | | | | | | | | |
| Broadcasting frequency | kHz | kHz | kHz | kHz | kHz | kHz | kHz | kHz |

PIONEER ELECTRONIC CORPORATION 4-1, Meguro 1-Chome, Meguro-ku, Tokyo 153, Japan
PIONEER ELECTRONICS (USA) INC. 1925 E. Dominguez St., Long Beach, California 90810 U.S.A.
PIONEER ELECTRONIC (EUROPE) N.V. Keetberglaan 1, 2740 Beveren, Belgium
PIONEER ELECTRONICS AUSTRALIA PTY. LTD. 178-184 Boundary Road, Braeside, Victoria 3195, Australia

<84D01F4D09>

Printed in Japan/Imprimé au Japon<ARB-578-A>