

## MX132 AV Control Center

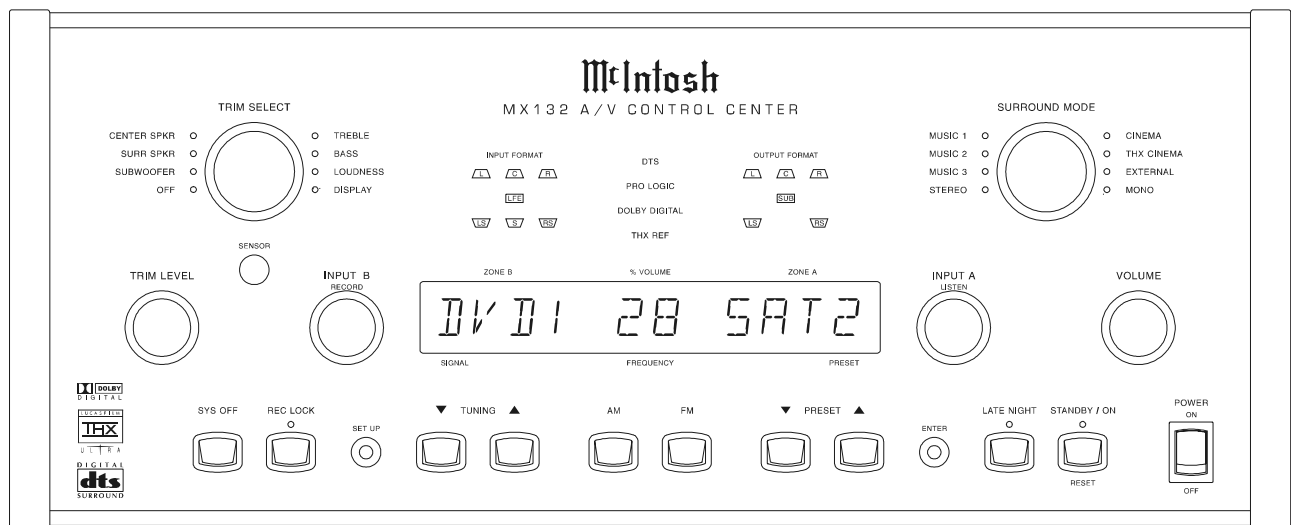

Manufactured under license from Dolby Laboratories, “Dolby”, “Pro Logic” and the double-D symbol are registered trademark of Dolby Laboratories. “DTS”, “digital surround”, and “coherent acoustics” are registered trademark of DTS Technology, LLC. and manufactured under license from DTS Technology LLC. Lucasfilm, THX, the THX logo, Re-Equalization, Re-EQ, Timbre Matching, Decorrelation, Bass Management, and Loudspeaker Position Time Synchronization are registered trademarks of Lucasfilm, Ltd and manufactured under license from Lucasfilm Ltd.

## MX132

### Thank You

Your decision to own this McIntosh MX132 A/V Tuner Control Center ranks you at the very top among discriminating music listeners. You now have “The Best.” The McIntosh dedication to “Quality,” is assurance that you will receive many years of musical enjoyment from this unit.

Please take a short time to read the information in this manual. We want you to be as familiar as possible with all the features and functions of your new McIntosh.

### Please Take A Moment

The serial number, purchase date and McIntosh dealer name are important to you for possible insurance claim or future service. The spaces below have been provided for you to record that information:

**Serial Number:** \_\_\_\_\_

**Purchase Date:** \_\_\_\_\_

**Dealer Name:** \_\_\_\_\_

### Technical Assistance

If at any time you have questions about your McIntosh product, contact your McIntosh dealer who is familiar with your McIntosh equipment and any other brands that may be part of your system. If you or your dealer wish additional help concerning a suspected problem, you can receive technical assistance for all McIntosh products at:

McIntosh Sales Corporation  
661 W. Redondo Beach Blvd.  
Gardena, CA 90247  
Phone: 888-979-3737  
Fax: 310-217-9288

### Customer Service

If it is determined that your McIntosh product is in need of repair, you can return it to your dealer. You can also return it to the McIntosh Laboratory Service Repair department. For assistance on factory repair return procedure, contact the McIntosh Repair Department at:

McIntosh Laboratory, Inc.  
2 Chambers Street  
Binghamton, New York 13903  
Phone: 607-723-3515  
Fax: 607-723-1917

Copyright 1998 © by McIntosh Laboratory, Inc.

### Table of Contents

Thank You .....	2
Please Take a Moment .....	2
Technical Assistance .....	2
Customer Service .....	2
Table of Contents .....	2
General Notes .....	3
Connector Information .....	3
Safety Instructions .....	4
Introduction .....	6
Performance Features .....	6
Installation .....	8
<b>Connections</b>	
Rear Panel Multizone, Control and Antenna Connections .....	9
Rear Panel Audio and Digital Connections .....	10
Rear Panel Video Connections .....	11
How to Connect Multizone, Control and Antenna Components .....	12
How to Connect Audio and Digital Components .....	13
How to Connect Video Components .....	14
How to Connect the MX132 for Zone B .....	15
<b>Front Panel Features</b>	
Front Panel Controls, Pushbuttons, Switch and Sensor .....	16
Front Panel Displays .....	17
<b>Remote Control</b>	
Remote Control Pushbuttons .....	18
How to operate the Remote Control .....	19
<b>Setup Mode</b>	
How to Operate the Setup Mode .....	20
Default Settings .....	21
How to Adjust for Loudspeaker Size .....	23
How to Adjust for Loudspeaker Time Delay .....	24
How to Adjust for Loudspeaker Levels .....	26
How to Adjust for Bass Limiter .....	28
How to Reassign the Analog Inputs .....	29
How to Reassign the Digital Inputs .....	30
How to Assign the Video Power Control .....	31
How to Assign the Video Converter .....	32
How to Adjust Zone B Volume Preset .....	33
How to Optimize AM Reception .....	33
<b>Operation</b>	
How to Operate the MX132 .....	34
How to Operate the FM Tuner .....	36
How to Operate the AM Tuner .....	38
How to Operate the Trim Mode .....	40
How to Operate the Surround Mode .....	42

### Table of Contents con't

How to Operate Remote Zones .....	44
<b>Additional Information</b>	
Performance Charts .....	46
Specifications .....	49
Packing Instruction .....	51

### General Notes

1. Connecting Cables and Connectors are available from the McIntosh Parts Department:  
**Data and Power Control Cable Part No. 170-202**  
 Six foot, shielded 2 conductor, with 1/8 inch stereo mini phone plugs on each end.  
**Control Center to Multi Channel Power Amplifier Cable Part No. 170-631**  
 Six foot, DB25, shielded, straight through, 25 conductor male-to-female cable.  
**Control Center to CR12 Cable Part No. 170-430**  
 Six foot, DB37, shielded, straight through, 37 conductor male-to-male cable.  
**CR12 Keypad Terminal Plug Part No. 117-634**  
 Five Pin connector for attaching the 4 conductor cable to the CR12 Keypad Socket.
2. For additional connection information, refer to the owner's manual(s) for any component(s) connected to the MX132 A/V Tuner Control Center.
3. When the MX132 is connected to a McIntosh MC7205 Power Amplifier with a 25 conductor cable, the amplifier meters will automatically indicate the output of each individual channel during the Speaker Level Setup Operation. This meter function is independent of any Meter Mode selections on the MC7205 front panel.
4. When the MX132 is connected to a CR12 Controller Input B jack with the 37 conductor cable, do not connect a 25 conductor cable to the CR12 Controller Input A jack from another McIntosh Control Center.
5. System Setup operations must be performed in the order they appear in the Main System Setup Menu as they are interactive.
6. The Zone A and Zone B IR Inputs, with 1/8 inch mini phone jacks, are configured for non-McIntosh IR sensors such as a Xantech Model 291-10. To avoid possible interaction, disable the MX132 Front Panel Sensor with the switch recessed in the bottom panel behind the Setup pushbutton.
7. In order to hear bass frequencies below 80Hz, your system must include either a subwoofer or Large Front loudspeakers.
8. Zone B Video is composite only. A Digital Audio Input Signal Source will not appear at the Zone B Audio Outputs. The source component must also have its Analog Outputs to be connected to an Analog Input heard in Zone B.

9. When an assigned Digital input and a matching Analog input are in use, the MX132 automatically searches first for a Digital signal which is then fed to the appropriate decoder circuits. If no digital signal is sensed, it switches to the Analog input to send an analog signal to the appropriate decoder circuits.
10. Certain DVD or Laser Video Disc players that are reproducing Digital DTS signals fed to an MX132 Digital input, may feed only noise from their Analog outputs at the same time. If Zone B is turned on and the matching MX132 Analog input is selected, the noise will be heard.
11. When the MX132 is connected with a CR12, the MX132 provides fixed specific audio signals that match the CR12 inputs. For example, if the MX132 TV input (7), is reassigned as DVD2, selecting the TV input on the CR12 will receive the audio signals from DVD2 connected to the MX132 input Number 7.

<u>MX132 Inputs</u>	<u>CR12 Matching Inputs</u>
0. (TUNER)	TUNER
1. (AUX)	AUX
3. (CD2)	CD2
4. (TAPE 1)	TAPE 1
7. (TV)	TV
8. (LV)	LV
9. (VCR1)	VCR1
11. (DVD)	VAUX (DVD)

### Connector Information

#### Keypad Terminal Connector

To use a WK-3 or WK-4 keypad, connect the shield and four leads of a shielded 4 conductor cable to a keypad terminal connector, according to the numbers listed below. There is a similar numbered connector built-in to each keypad.

1. Supply Voltage Positive
2. Supply Voltage Ground
3. Cable Shield
4. Signal Data
5. Signal Data Ground

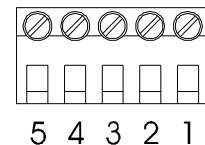

#### Din Connector Pin Layouts for Balanced Outputs

1. Left Channel (-)
2. (Not used)
3. Right Channel(-)
4. Left Channel Ground
5. Right Channel Ground
6. Left Channel (+)
7. Right Channel (+)

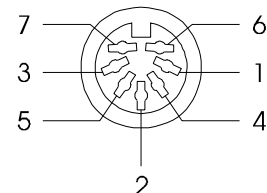

## IMPORTANT SAFETY INSTRUCTIONS!

PLEASE READ THEM BEFORE OPERATING THIS EQUIPMENT.



### WARNING SHOCK HAZARD - DO NOT OPEN.

The lightning flash with arrowhead, within an equilateral triangle, is intended to alert the user to the presence of uninsulated “dangerous voltage” within the product’s enclosure that may be of sufficient magnitude to constitute a risk of electric shock to persons.



### AVIS RISQUE DE CHOC - NE PAS OUVRIR.

The exclamation point within an equilateral triangle is intended to alert the user to the presence of important operating and maintenance (servicing) instructions in the literature accompanying the appliance.



### NO USER-SERVICEABLE PARTS INSIDE. REFER SERVICING TO QUALIFIED PERSONNEL



To prevent the risk of electric shock, do not remove cover (or back). No user serviceable parts inside. Refer servicing to qualified personnel.

#### General:

1. Read all the safety and operating instructions, contained in this owner’s manual, before operating this equipment.
2. Retain this owner’s manual for future reference about safety and operating instructions.
3. Adhere to all warnings and operating instructions.
4. Follow all operating and use instructions.
5. **Warning: To reduce risk of fire or electrical shock, do not expose this equipment to rain or moisture. This unit is capable of producing high sound pressure levels. Continued exposure to high sound pressure levels can cause permanent hearing impairment or loss. User caution is advised and ear protection is recommended when playing at high volumes.**
6. **Caution: to prevent electrical shock do not use this (polarized) plug with an extension cord, receptacle or other outlet unless the blades can be fully inserted to prevent blade exposure.**

**Attention: pour prevenir les chocs electriques pas utiliser cette fiche polarisee avec un prolongateur, une prise de courant ou un autre sortie de courant, sauf si les lames peuvent etre inserees afond ans en laisser aucune partie a decouvert.**

7. For added protection for this product during a lightning storm, or when it is left unattended and unused for long periods of time, unplug it from the wall outlet and disconnect the antenna or cable system. This will prevent damage to the product due to lightning or power line surges.
8. Do not use attachments not recommended in this owner’s manual as they may cause hazards.

#### Installation:

9. Locate the equipment for proper ventilation. For example, the equipment should not be placed on a bed, sofa, rug, or similar surface that may block ventilation openings; or, placed in a built-in installation, such as a bookcase or cabinet, that may impede the flow of air through the ventilation openings.
10. Locate the equipment away from heat sources such as radiators, heat registers, stoves, or other appliance (including amplifiers) that produce heat.
11. Mount the equipment in a wall or cabinet only as described in this owner’s manual.
12. Do not use this equipment near water; for example, near a bathtub, washbowl, kitchen sink, laundry tub, in a wet basement or near a swimming pool, etc.
13. Do not place this product on an unstable cart, stand, tripod, bracket, or table. The equipment may fall, causing serious injury to a person, and serious damage to the product.

#### Connection:

14. Connect this equipment only to the type of AC power source as marked on the unit.
15. Route AC power cords so that they are not likely to be walked on or pinched by items placed upon or against them, paying particular attention to cords at plugs, convenience receptacles, and the point where they exit from the instrument.
16. Do not defeat the inherent design features of the polarized plug. Non-polarized line cord adapters will defeat the safety provided by the polarized AC plug. If the plug should fail to fit, contact your electrician to replace your obsolete outlet. Do not defeat the safety purpose of the grounding-type plug.

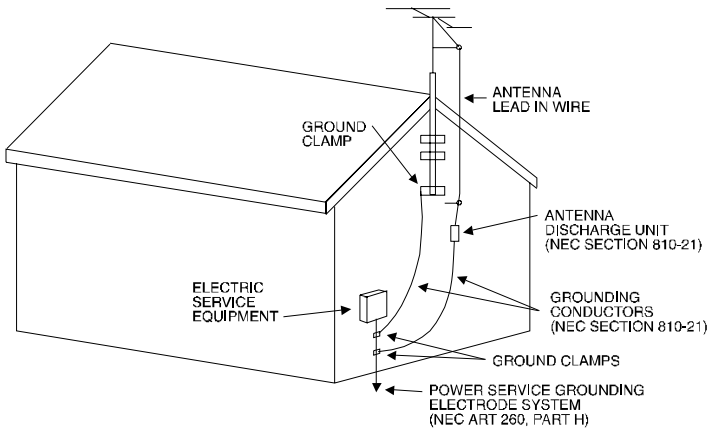

17. Do not overload wall outlets, extension cords or integral convenience receptacles as this can result in a risk of fire or electric shock.

### Outdoor Antenna:

18. If an outdoor antenna is connected to the antenna terminal, be sure the antenna system is grounded to provide some protection against voltage surges and built up static charge. In the U.S.A., section 810 of the National Electrical Code, ANSI/NFPA No. 70-1978, provides information on the proper ground for the mast and supporting structure, ground for the lead-in wire to an antenna discharge unit, and size of ground conductors, location of antenna-discharge unit, connection to ground electrode. For ground wire:
  - A. Use No. 10 AWG (5.3 mm<sup>2</sup>) copper No. 8 AWG (8.4 mm<sup>2</sup>) aluminum, No. 17 AWG (1.0 mm<sup>2</sup>) copper-clad steel, bronze, or larger as ground wire.
  - B. Secure antenna lead-in and ground wires to the house with stand-off insulators spaced from 4 feet (1.2 meters) to 6 feet (1.83 meters) apart.
  - C. Mount antenna discharge unit as closely as possible to where lead-in enters house.
  - D. Use jumper wire not smaller than No. 6 AWG (13.3 mm<sup>2</sup>) copper or equivalent when separate antenna grounding electrode is used.

### Care of Equipment:

19. Clean the instrument by dusting with a dry cloth. Unplug this equipment from the wall outlet and clean the panel with a cloth moistened with a window cleaner. Do not use liquid cleaners or aerosol cleaners.
20. Do not permit objects of any kind to be pushed and/or fall into the equipment through enclosure openings.

Never spill liquids into the equipment through enclosure openings.

21. Unplug the power cord from the AC power outlet when left unused for a long period of time.

### Repair of Equipment:

22. Unplug this equipment from the wall outlet and refer servicing to a qualified service personnel under the following conditions:
  - A. The AC power cord or the plug has been damaged.
  - B. Objects have fallen, or liquid has been spilled into the equipment.
  - C. The equipment has been exposed to rain or water.
  - D. The equipment does not operate normally by following the operating instructions contained within this owner's manual. Adjust only those controls that are covered by the operating instructions, as an improper adjustment of other controls may result in damage and will often require extensive work by a qualified technician to restore the product to its normal operation.
  - E. The equipment has been dropped or damaged in any way.
  - F. The equipment exhibits a distinct change in performance - this indicates a need for service.
23. Do not attempt to service beyond that described in the operating instructions. All other service should be referred to qualified service personnel.
24. When replacement parts are required, be sure the service technician has used replacement parts specified by McIntosh or have the same characteristics as the original part. Unauthorized substitutions may result in fire, electric shock, or other hazards.
25. Upon completion of any service or repairs to this product, ask the service technician to perform safety checks to determine that the product is in proper operating condition.



### Introduction

Now you can take advantage of traditional McIntosh standards of excellence in the MX132 A/V Tuner Control Center as the heart of your home theater system. The MX132 provides superior six channel reproduction, Dolby Digital and DTS decoding combined with complete audio and video switching. The McIntosh MX132 sets new standards for accuracy in a home theater system.

### Performance Features

#### ● 24 Bit DSP Processing and Conversion

Three 24 Bit Digital Signal Processors decode Dolby Pro Logic, Dolby Digital and DTS signals. Six 24 Bit digital to analog converters change the digital audio channels to analog. Two 24 Bit analog to digital converters change all analog input stereo signals to digital.

#### ● Digital Audio Input Switching

Three Digital Coaxial and three Digital Optical inputs are provided for six different digital program sources.

#### ● On Screen Displays

A comprehensive On-Screen Display capability makes it easy to perform a setup adjustments using the MX132 Remote Control.

#### ● Audio/Video Inputs

Eleven Audio/Video inputs plus the Tuner provide for all popular program sources. Reliable, noiseless, distortion free electronic switching is used on all inputs.

#### ● Automatic Mode Switching

The MX132 automatically switches operating modes between Stereo, Pro-Logic, Dolby Digital or DTS, according to the input signal.

#### ● Re-Assignable Input Selection

The 11 Analog A/V and 6 Digital Audio Inputs can be re-assigned for any desired signal sources. Any unused input can be “turned off” so the input selector will skip over it. All six digital inputs can be assigned to any A/V signal source.

#### ● External IR Sensors

Rear panel connections are provided for external McIntosh Keypads for either Zone A or Zone B.

#### ● LED Channel Status Indicators

The MX132 includes thirteen LED's on the front panel to indicate what type of operating signals are being received and the output format chosen.

#### ● Pure Stereo Outputs

When stereo operation is selected for an analog source, pure, unprocessed stereo signals appear at the left and right front outputs.

#### ● Adjustable Channel Level

A built-in test signal generator allows all six channels to be calibrated for precise volume levels with either automatic or manual channel switching.

#### ● Adjustable Time Delay

All six channels can be adjusted for time delay to compensate for different distances from each loudspeaker to the listening area.

#### ● Precision Tracking Volume Control

An electronic Volume Control adjusts all six channels with tracking accuracy better than 0.5dB.

#### ● Digitally Controlled Tone Control

Digitally controlled bass, treble and loudness analog circuits provide a wide range of tone shaping with no loss in traditional McIntosh sonic excellence.

#### ● Composite / S Video Switching

Any Composite video input can be configured to send its video signal to the S Video output in addition to the Composite Video output.

#### ● External Six Channel Inputs

An external six channel signal processor can be connected to these inputs as well as a DVD player with a built-in processor.

#### ● Zone Expansion

A rear panel connector is provided to interface with the CR12 Remote Control System to add four additional Remote A/V zones.

#### ● Auto Memory of Mode Settings

Zone A will memorize the Preferred Mode settings last

used for each input. When switching from one input to another, the selected mode for each will be active.

- **Multifunction Fluorescent Display**

The front panel display indicates volume levels, tuner functions, input selection, operating mode and setup functions.

- **THX® Signal Processing**

The THX CINEMA SURROUND mode with THX Signal processing present will provide the best possible reproduction of a film sound track that was originally created for use in a movie theater. THX Re-Equalization™ and Timbre Matching™ takes the edginess or “brightness” out of your Home Theater sound and matches the tone of your front loudspeakers to your surrounds. Adaptive Decorrelation™ gives a stereo “feel” when your surrounds are playing mono and automatically switches off when they are playing stereo. Bass Management Electronic Crossover™ allows you to use more compact, easier-to-place loudspeakers, while sending bass to a subwoofer system, and Bass Peak Level Manager protects your subwoofer or Large loudspeaker from overloading. Loudspeaker Position Time Synchronization™ lets you easily set up your Home Theater system for an optimum listening position.

- **Late Night Dynamic Audio Compression**

With select Dolby Digital sound tracks, a dynamic volume compressor can be switched in to reduce the wide dynamic range of music and sound effects. This feature can be very useful for late night listening or when you have close neighbors.

- **Automatic Input Level Control**

The Analog Input includes a special circuit which protects against accidental input signal overdrive.

- **Full Remote Control**

All major operating functions including system setup can be performed with the remote control sending signals to the MX132 front panel IR sensor.

- **Speaker Settings for Bass Management**

The MX132 processing circuits allow you to change the bass cutoff frequency fed to the front, center and surround channels, when using a subwoofer.

- **Special FM RF Amplifier**

Double-Diffused Metal Oxide Field Effect Transistor (DMOS-FET) RF amplifier increases sensitivity and Cross Modulation rejection.

- **FM Stereo Auto Blend Circuitry**

An automatic variable stereo separation control circuit is used to reduce background noise when receiving weak stereo stations.

- **Preset Stations**

Nine AM and nine FM station presets make it easy to listen to your favorite stations.

- **External AM RF Amplifier**

The MX132 includes an electrostatically shielded AM RF Amplifier Stage with a shielded connecting cable that allows it to be located in a remote area, away from sources of interference. The Amplifier Stage can be adjusted for optimum signal strength at both ends of the AM dial and can be positioned for the best possible reception of even the weakest AM stations.

- **Permanent Memory**

Tuner station presets and setup adjustment options are retained in permanent memory even when AC power is turned off.

- **Dual Zone**

The MX132 has the built-in ability to control a separate remote audio/video zone with its own dedicated power amplifier and speakers. Zone B program selection is independent of the program selected in Zone A.

- **Listen and Record Circuitry**

Separate Record and Listen circuits allow you to record one program source while listening to another. Separate signal processor loops are provided for both the Listen and Record circuits.

- **Special Power Supply**

Fully regulated power supply with double shielded power transformer ensures stable noise free operation even if the power line should vary.

### Installation

The MX132 can be placed upright on a table or shelf, standing on its four feet. It also can be custom installed in a piece of furniture or cabinet of your choice. The required panel cutout, ventilation cutout and unit dimensions are shown.

Always provide adequate ventilation for your MX132. Cool operation ensures the longest possible operating life for any electronic instrument. Do not install the MX132 directly above a heat generating component such as a high powered amplifier. If all the components are installed in a single cabinet, a quiet running ventilation fan can be a definite asset in maintaining all the system components at the coolest possible operating temperature.

A custom cabinet installation should provide the following minimum spacing dimensions for cool operation. Allow at least 2 inches (5.1 cm) above the top and 1 inch (2.54 cm) on each side of the control center, so that airflow is not obstructed. Allow 21 inches (53.3 cm) depth behind the mounting panel, which includes clearance for connectors. Allow 1-1/8 inches (2.9 cm) in front of the mounting panel for knob clearance. Be sure to cut out a ventilation hole in the mounting shelf according to the dimensions in the drawing.

**Front View of the MX132 custom installed**

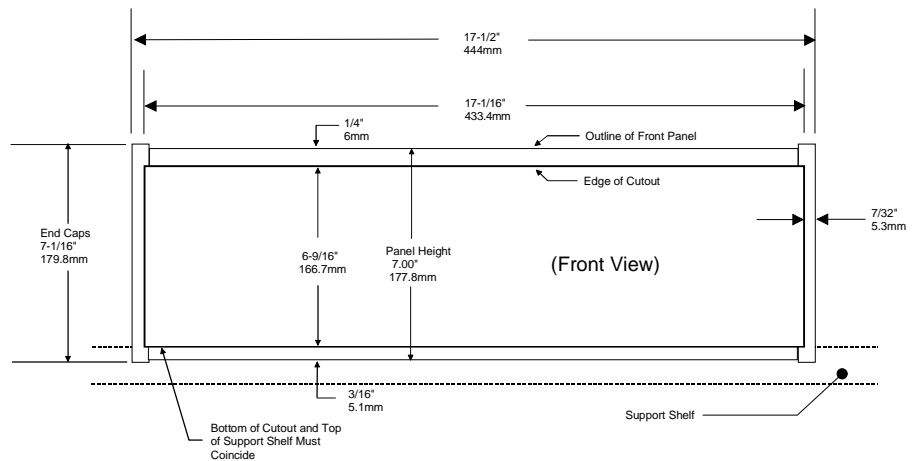

**Side View of the MX132 custom installed**

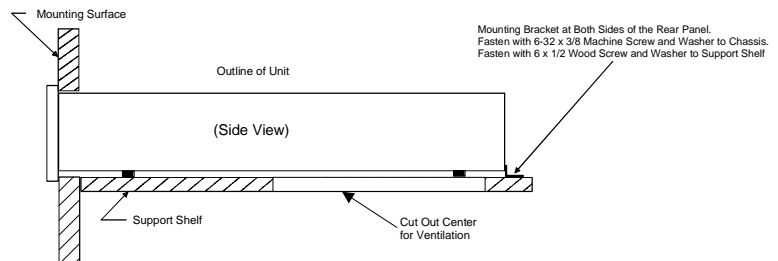

**Bottom View of the MX132 custom installed**

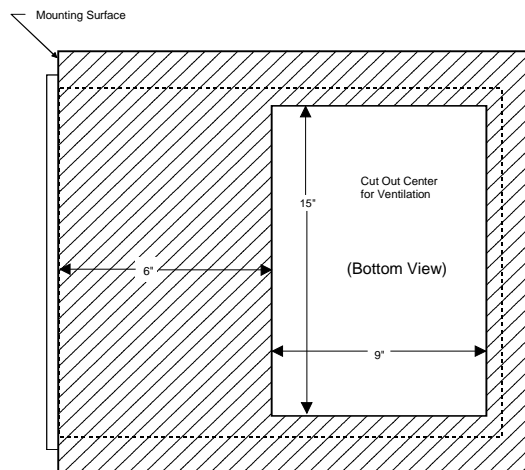



# MX132 Rear Panel Multizone, Control and Antenna Connections

## MX132 Rear Panel Multizone, Control and Antenna Connections

RAA1 Remote Antenna can be adjusted to a position for optimum reception of your favorite AM stations

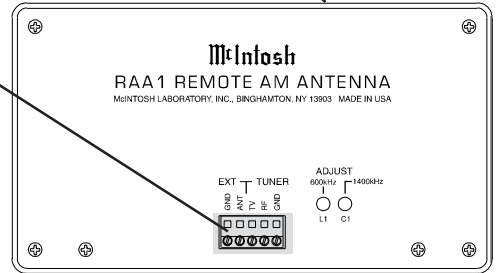

TO MULTIZONE CONTROLLER connects to the McIntosh Multizone Controller Input B

SUM A Data Port for Zone A connects to the optional McIntosh Remote Control Translator

Connects with supplied cable to the MX132

SUM Data Port for Zones A&B connects to the optional McIntosh Remote Control Translator

KEYPADS Zone A&B for a McIntosh Keypad or IR room sensor

RS232 connector for connection to a computer or other control device

DATA PORTS send signals to compatible source components to allow you to remotely control them

AM ANT (Antenna) connector allows a McIntosh Remote Antenna to be connected

IR Input for Zone A or B external Sensors

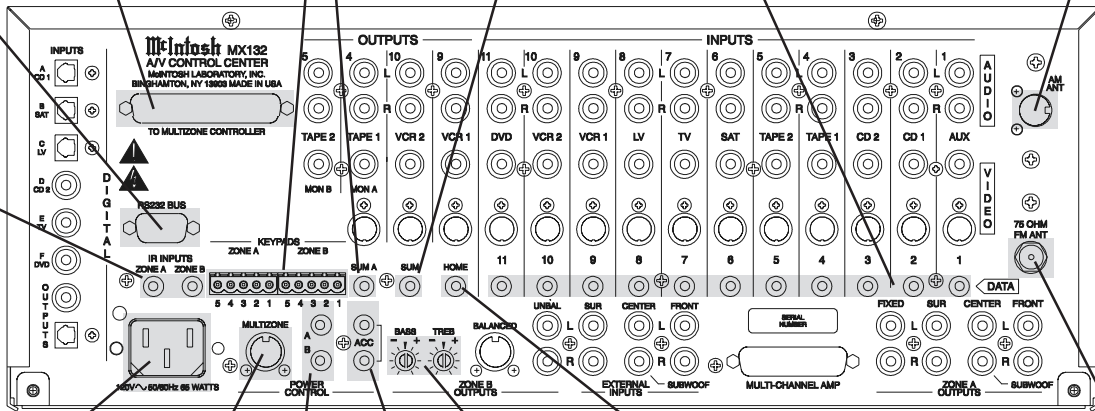

Connect the MX132 power cord to a live AC outlet. Refer to information on the back panel to determine the correct voltage

MULTIZONE sends turn on/off signals to a McIntosh Power Controller

A and B sends turn on/off signals to a McIntosh Power Amplifier for both Areas

ACC sends turn on/off signals to McIntosh Source Components

BASS and TREBLE controls provide  $\pm 12\text{dB}$  adjustment from the flat center position

HOME Data Port connects to the optional HC-1 Home Controller

75ohm FM ANT (Antenna) connects to an external FM antenna or cable

### MX132 Rear Panel Audio and Digital Connections

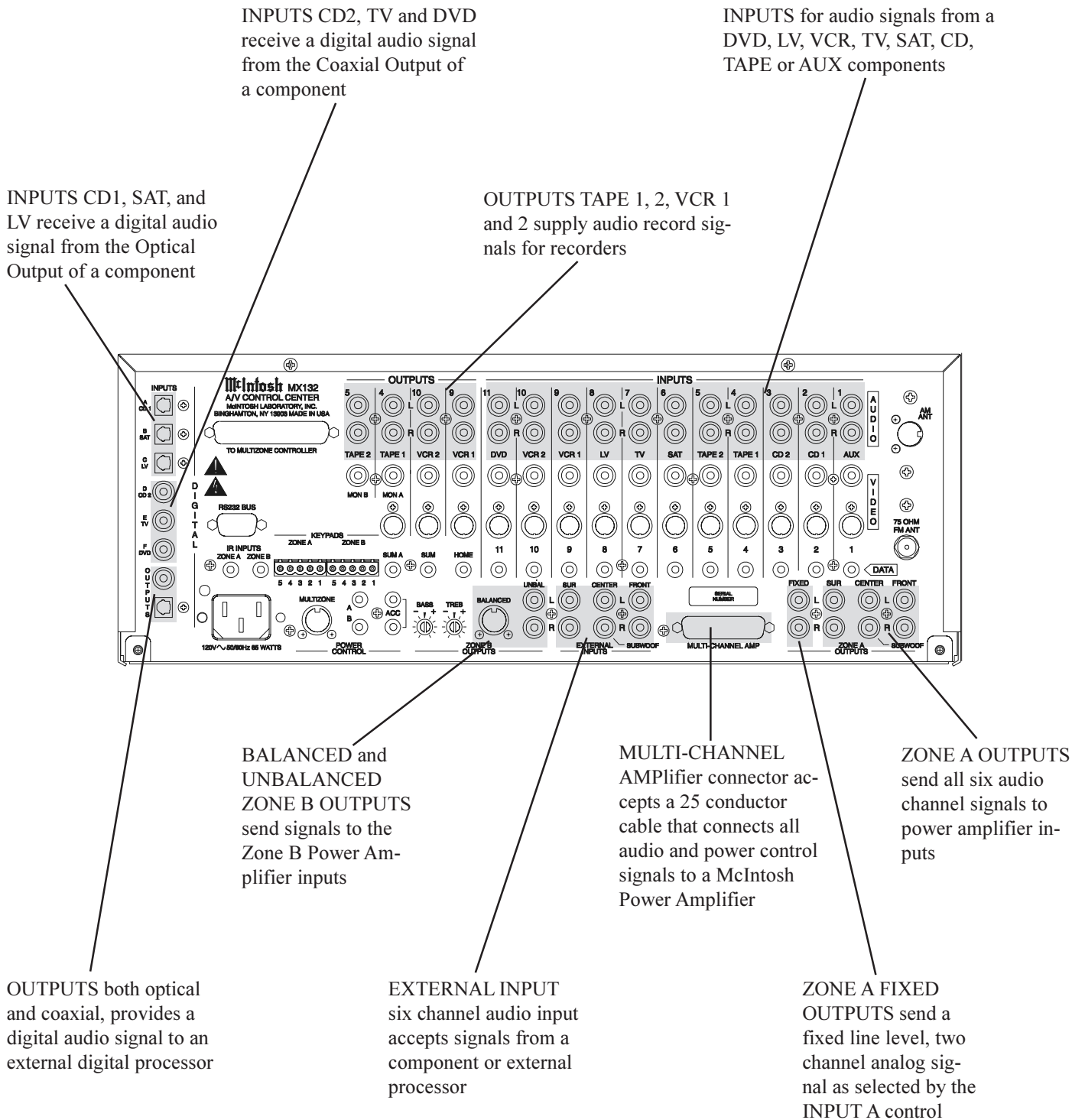

MX132 Rear Panel Video Connections

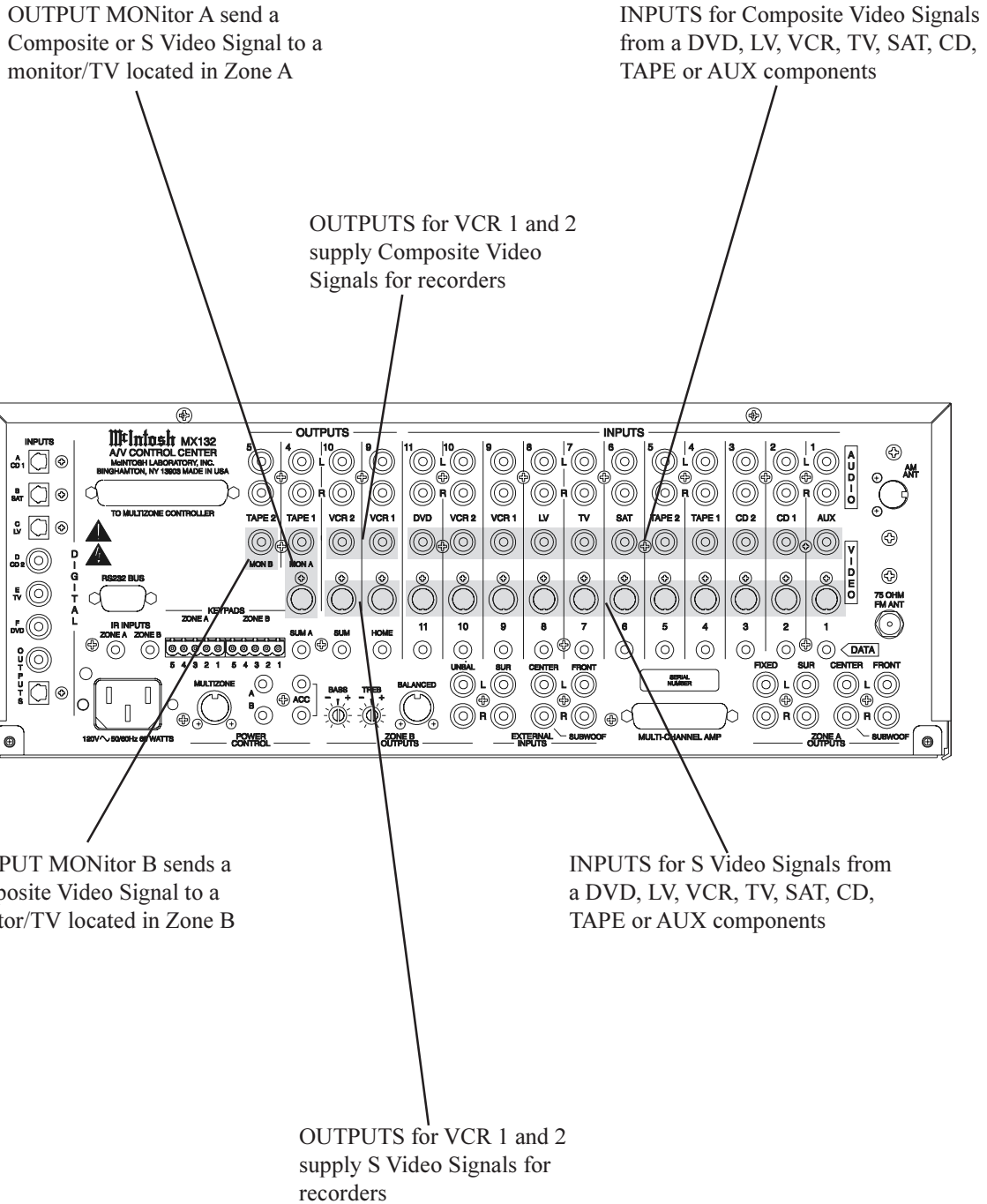

### How to Connect Multizone, Control and Antenna Components

1. Connect the MX132 to a live AC outlet.
2. Connect the Remote AM antenna by plugging the DIN connector of the supplied 3 conductor cable into the AM ANT, DIN socket on the back panel of the MX132. Connect the other end of the cable to the terminals on the Remote AM antenna according to the color code shown below:

Wire Color	Connecting Terminal
Red	TV
Black	RF
Green	GND

3. Connect a cable from the MX132 LV (8) data port to the MLD7020 Control Out jack.

4. Connect a cable from the MX132 Home data port to the data input of an HC-1 Home Controller.
5. Connect a cable from the MX132 A Power Control jack to the Power Control In jack on a McIntosh RFD2 AC-3 RF Demodulator.
6. Connect a DIN cable from the MX132 Multizone jack to the DIN Multizone jack on a McIntosh PC-3 Power Controller.
7. Connect a 4 conductor shielded cable from the MX132 Zone A Keypad terminals to a WK-3 or WK-4 keypad.
8. Connect a shielded straight through 37 conductor, DB37 cable from the MX132 "To Multizone Connector" to the CR12 Multizone "Controller Input B" socket.
9. Connect a 75 ohm coax cable from an FM antenna or cable system to the MX132, 75 ohm FM ANT connector.

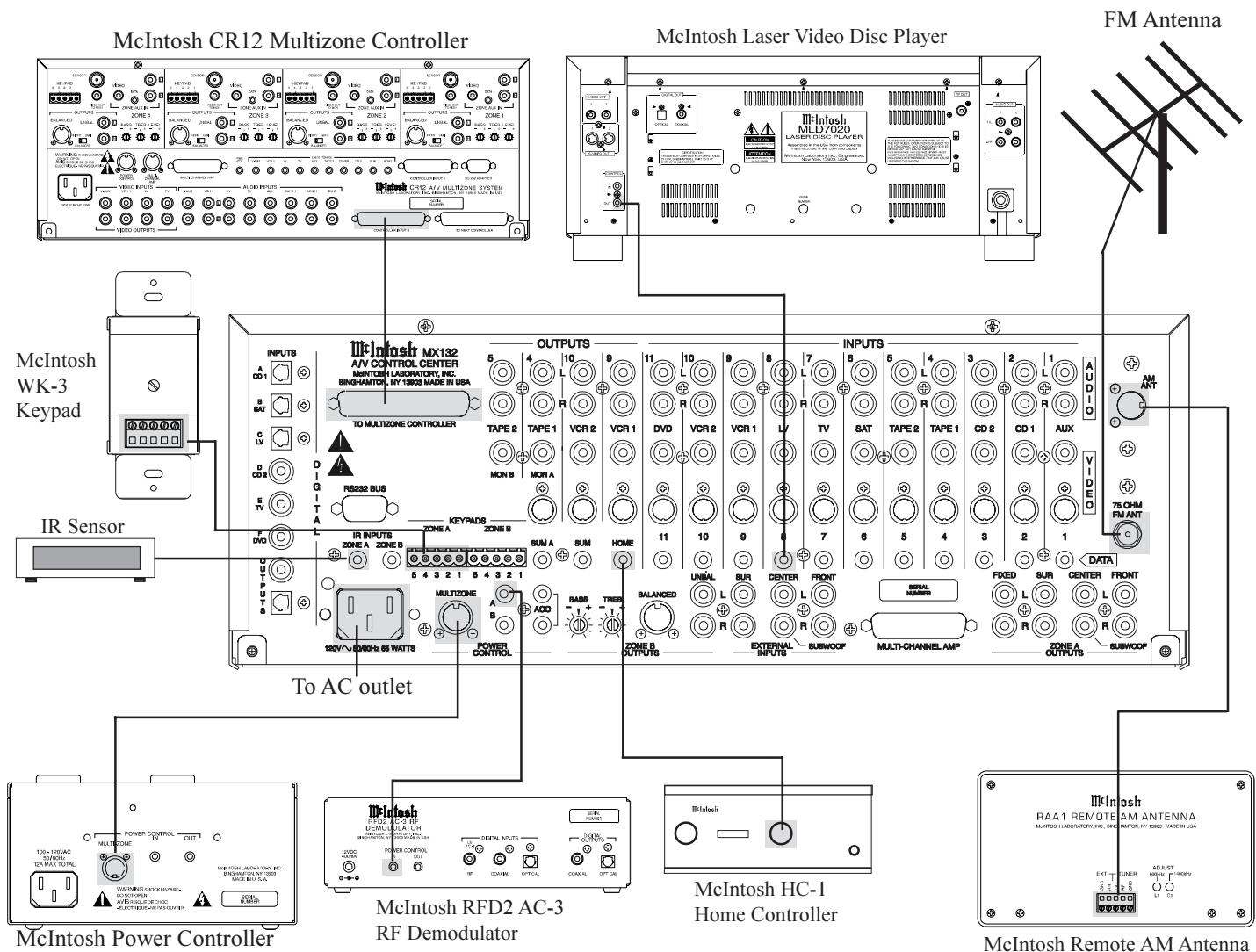

## How to Connect Audio and Digital Components

1. Connect the MX132 "Multi-Channel AMP" to the THX Input socket on an MC7205 amplifier with a 25 conductor, shielded straight through male to female DB25 cable.
2. Connect cables from MX132 LV (8) audio inputs to the analog outputs of a McIntosh MLD7020 laser video disc player.
3. Connect the MX132 LV (C) Digital Optical input to the Digital Optical output of a McIntosh RFD2 AC-3 RF Demodulator.
4. Connect the MX132 Digital Optical Output to the input of a digital processor, and the processor outputs to the MX132 External Inputs.
5. Connect the MX132 Digital Coaxial DVD (F) Input to the coaxial digital output of a DVD player.
6. Connect the MX132 SAT (B) Optical Digital Input to the optical digital output of a Satellite receiver.
7. Connect the MX132 CD2 (D) Digital Coaxial Input to the Digital Coaxial Output of a McIntosh MCD7010 CD player.
8. Connect the MX132 VCR1 (9) inputs to the outputs of a VCR and the MX132 VCR1 (9) Outputs to the VCR inputs.

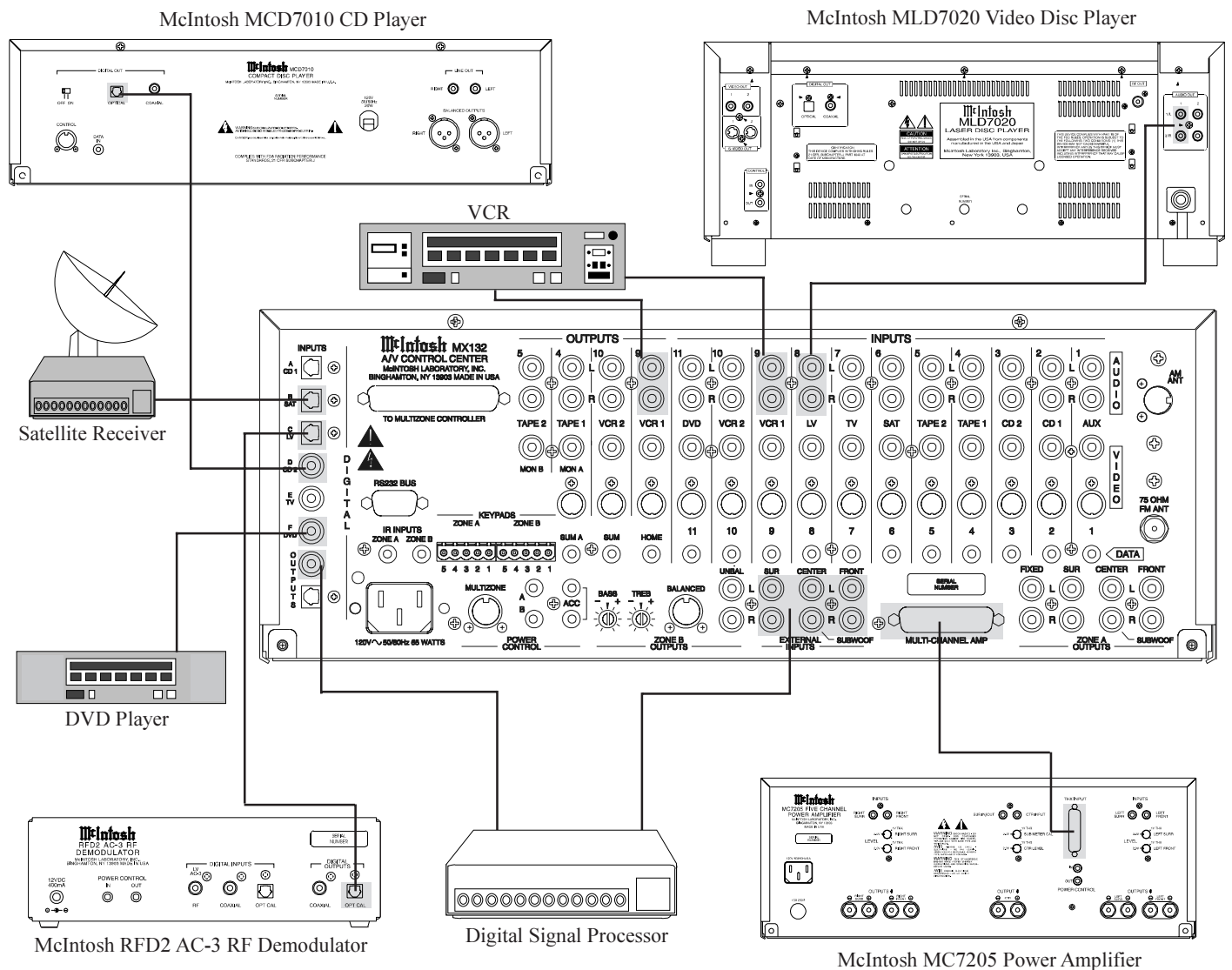



### How to Connect Video Components

Two types of video source components may be used with the MX132. There are playback only components such as a DVD player or Laser Video Disc player, and record-playback components such as a VCR. These components may have either "S" or Composite connectors or a combination of both. Video components with "S" connectors were selected for the hookup example shown below.

**NOTES:**

1. "S" input video signals will appear at all three of the "S" video outputs which include VCR 1, VCR 2 and MON A.
2. Composite input video signals will appear at all four of the Composite video outputs which include VCR 1, VCR 2, MON A and MON B.
3. The Composite video input signals can also be converted to "S" signals at the MON A "S" output using a built-in MX132 circuit.
4. The MON B output is Composite only, due to the long cable lengths normally required to reach a second room. This avoids the video signal quality problems associated with long "S" video cables.

5. Most VCR's that have "S" connectors also have Composite connectors as well, making it unnecessary for the MX132 to convert VCR tape out signals from Composite to "S".
6. Both Composite and "S" video inputs can be used at the same time.

1. Connect the MX132 LV "S" (8) Video Input to the "S" video output of a McIntosh MLD7020 laser video disc player.
2. Connect the MX132 DVD "S" (11) Video Input to the "S" video output of a DVD player.
3. Connect the MX132 SAT "S" (6) Video Input to the "S" video output of a Satellite receiver.
4. Connect the MX132 VCR1 "S" (9) Video Input to the "S" video output of a VCR and the MX132 VCR1 "S" (9) Output to the VCR "S" video input.
5. Connect the MX132 MON A "S" Video Output to the "S" video input of a video Monitor.

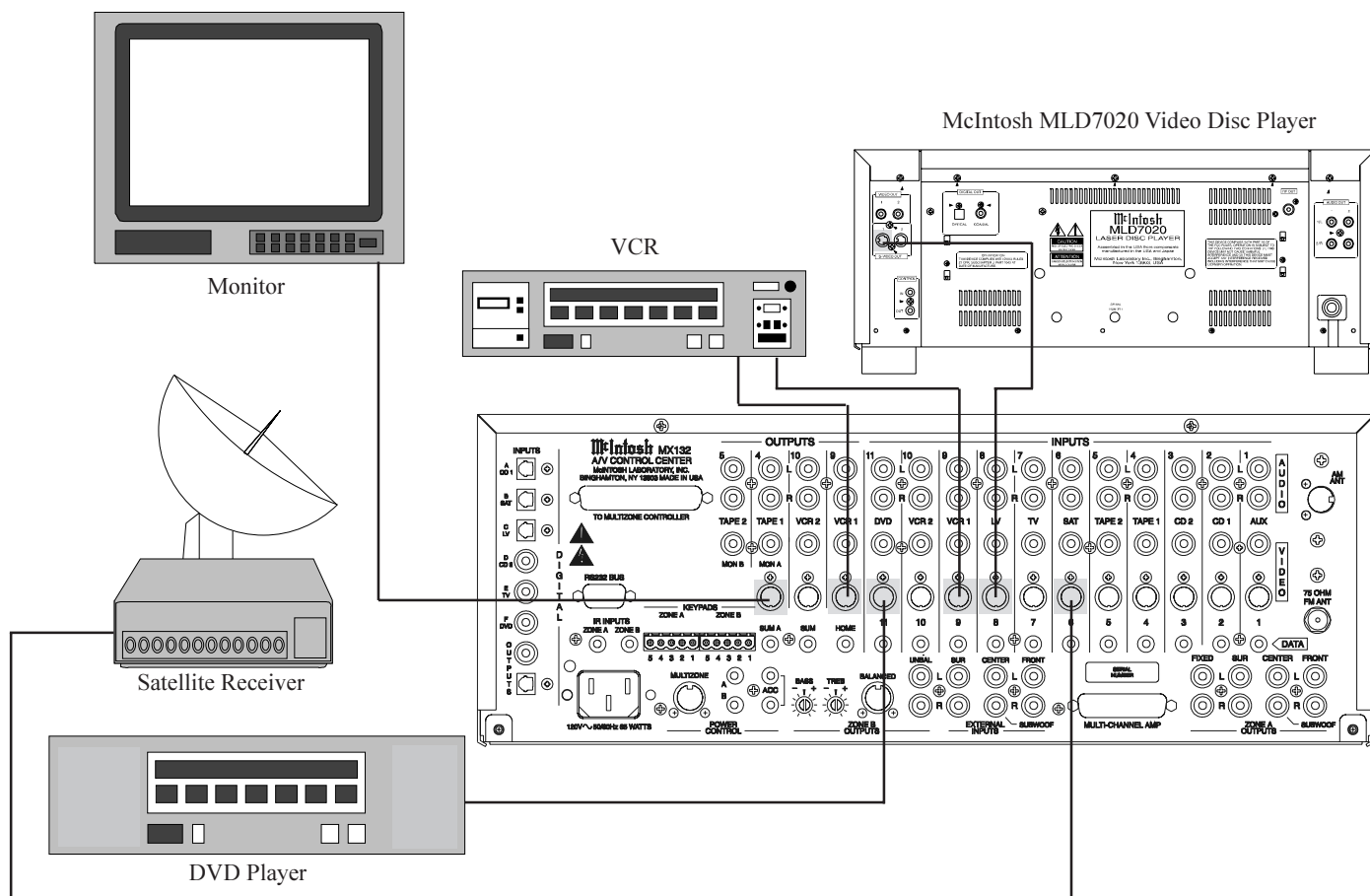

## How to Connect the MX132 for Zone B

1. Connect audio cables from the Unbalanced Zone B Outputs to the Zone B power amplifier inputs.

*Note: An optional Zone B audio connection is to use balanced cables from the Balanced Zone B (DIN) connector to the balanced inputs on a Zone B power amplifier.*

2. Connect a video cable from MON B composite Video Output to the composite video input of a Zone B monitor.
3. Connect a Power Control cable from the MX132 B Power Control jack to the Power Control Input of the Zone B power amplifier.
4. Connect a cable from the Zone B Keypad connector to a WK-3 or WK-4 Keypad in Zone B.

5. Connect the MX132 DVD (11) Digital Composite Video Input to the Composite Video output from a DVD player.
6. Connect the MX132 DVD (11) Analog input to the DVD player analog output.

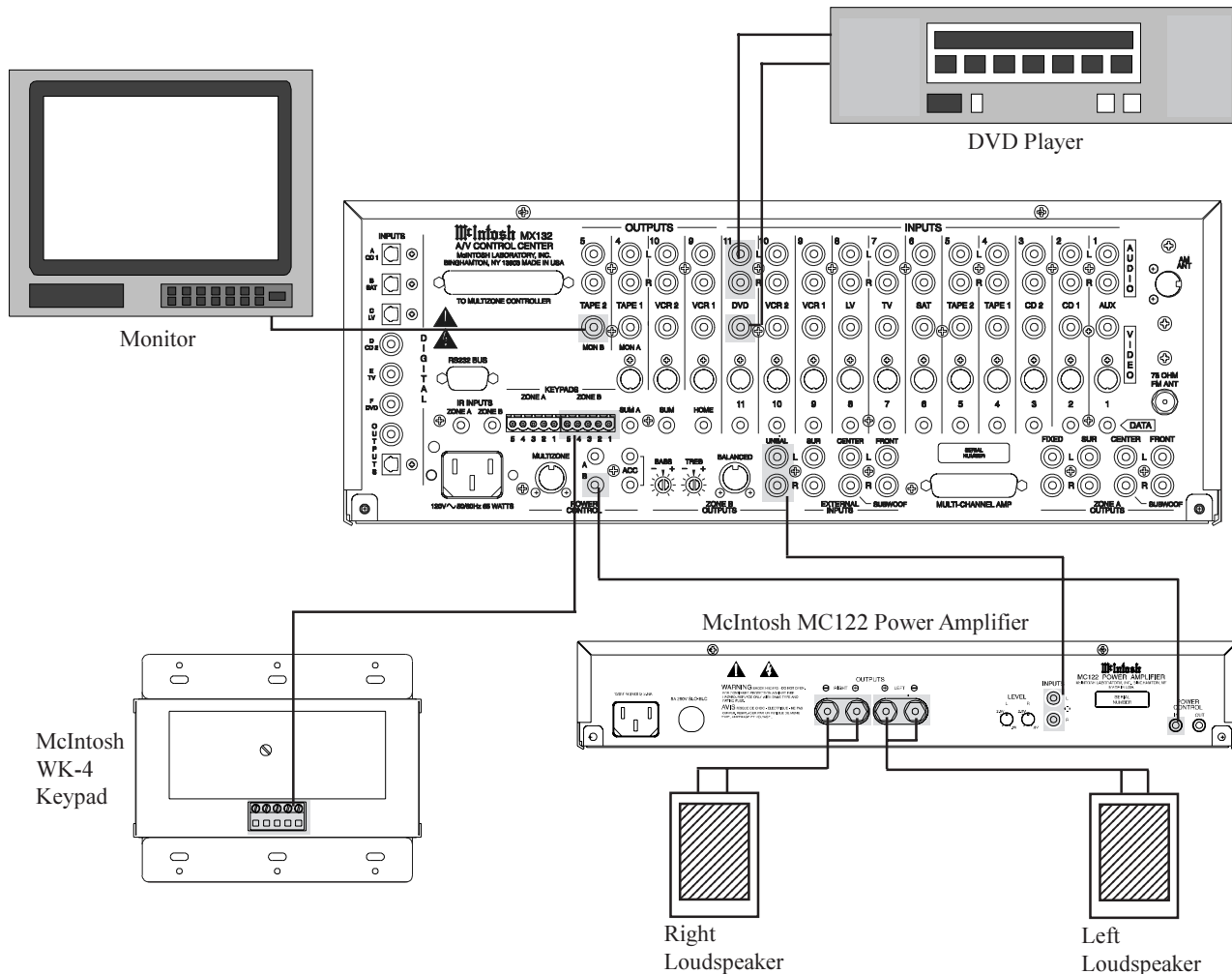



Front Panel Displays

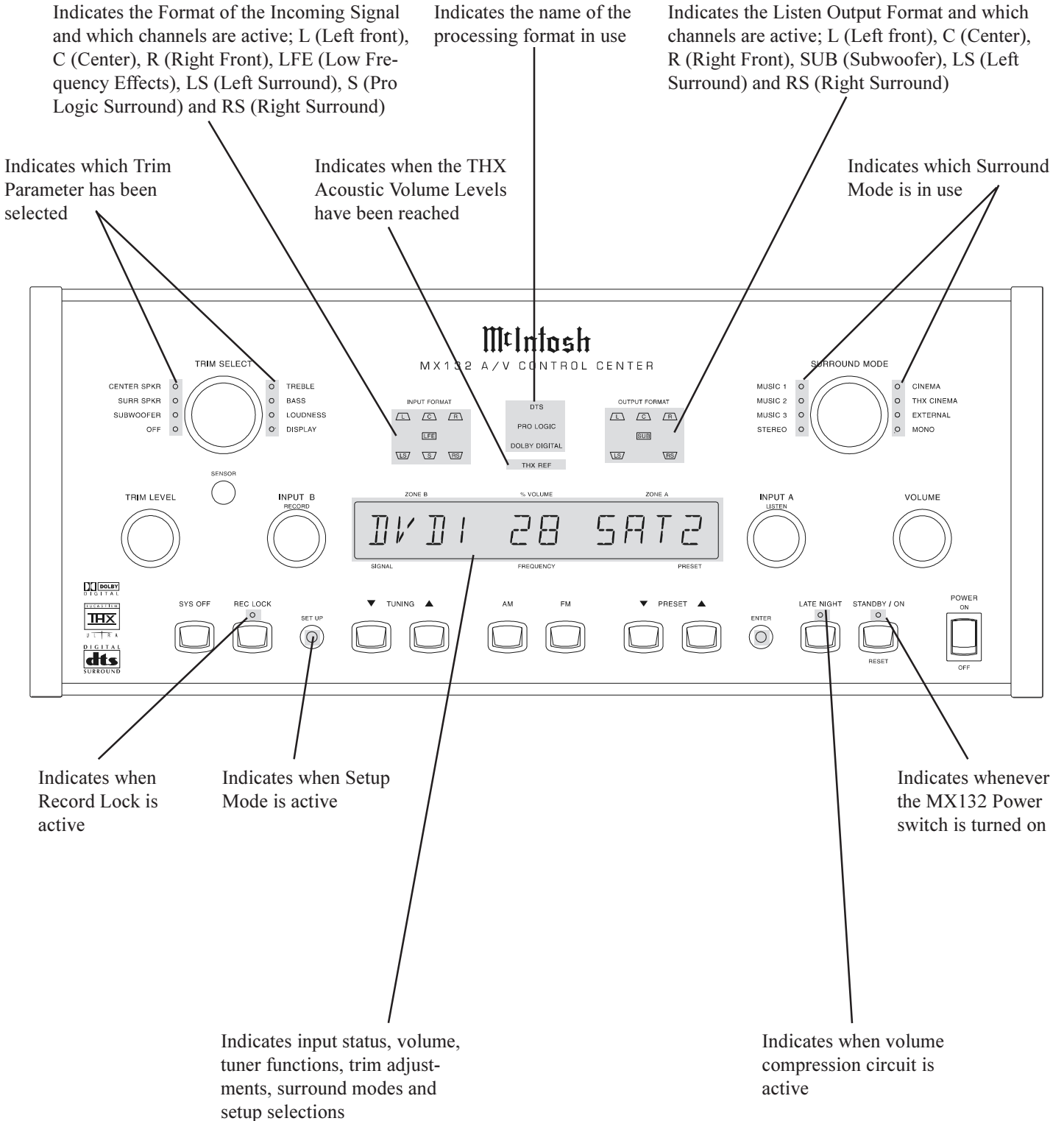

### MX132 Remote Control Pushbuttons

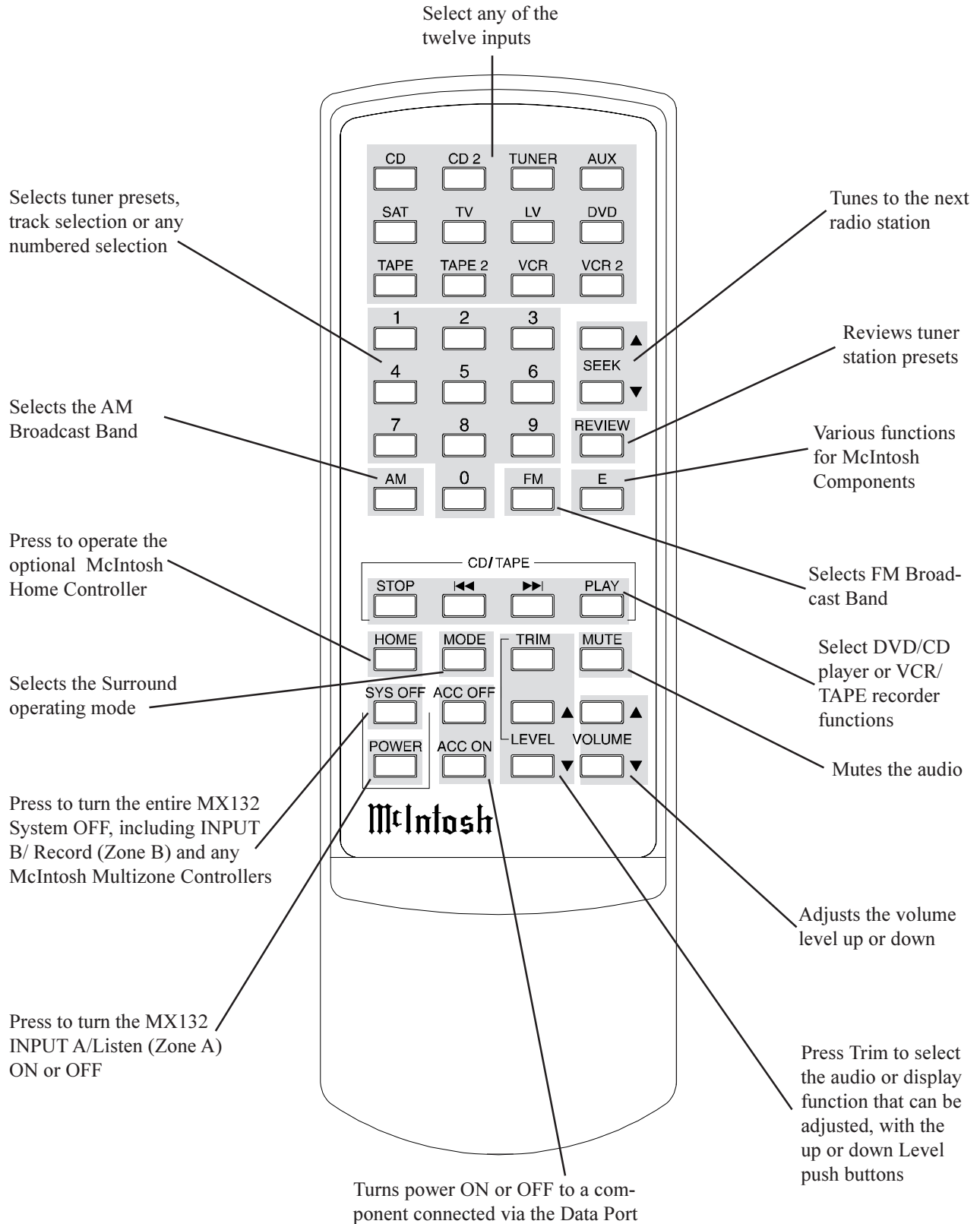



### How to Operate the Remote Control

#### Mute

Press the MUTE pushbutton to mute audio in all Input A outputs. The front panel display will indicate Mute. Press Mute again to unmute audio. In Zone B, press MUTE to mute only Zone B audio. The LED in the Zone B IR wall sensor or keypad will blink on and off to indicate MUTE is active. Press MUTE a second time to unmute Zone B audio.

#### Audio

Press any of the twelve input pushbuttons to select an audio or audio/video program source. The non-numbered Input pushbuttons also are used to reassign Digital and Analog inputs.

#### CD/Tape

Press these pushbuttons to operate a CD player, CD changer or tape recorder, when the component is connected to the MX132 with a McIntosh RCT Translator.

#### Tuner Pushbuttons

Select AM or FM broadcast band. Press and release SEEK Up or Down to move from station to station. Press and hold a SEEK Press-button to move continuously from station to station. Press REVIEW to start the automatic brief audition of each of the presets stored in the tuner memory. Press REVIEW a second time to stop on a station preset and exit the Review process.

#### Volume

Press a VOLUME Up or Down pushbutton to raise or lower the listening volume level in either Zone A or B. The TAPE and VCR Outputs are not affected.

#### Trim

Press TRIM to enter the TRIM adjustment mode. TRIM adjustments are performed with the LEVEL pushbuttons. Press TRIM again to cycle through the TRIM modes.

#### Numbered Pushbuttons

Press 0 through 9 to access tuner station presets, CD tracks/discs and performs various functions with McIntosh Components.

#### Home

When the optional HC-1 Home Controller is added to the MX132 system, Press the HOME Pushbutton to select the HC-1. Within 5 seconds Press one of the numbered pushbuttons to activate a desired relay in the HC-1.

#### Sys Off

Press SYS OFF (System Off), to turn off the entire McIntosh Audio/Video system.

#### Power

Press POWER to turn on the zone where the Remote Control is located.

#### E

Press E to perform various functions on a variety of McIntosh Components.

#### Mode

Press the MODE pushbutton to change operating modes and performs various functions with McIntosh Components.

#### Level

Press a LEVEL Up or Down pushbutton to make Trim adjustments and performs various functions with McIntosh Components.

#### ACC ON - OFF

Press ACC ON or ACC OFF to turn power ON and OFF of components that are connected with a McIntosh RCT Translator - Repeater. Only the ACC ON Pushbutton is active with the McIntosh LV or DVD Disc Player.

*NOTE: When other brands of components are connected with a McIntosh RCT Translator, refer to the RCT Owner's Manual for further information on alternate Remote Control pushbutton functions.*

#### Alternate MX132 Pushbutton Functions

<u>MX132 pushbutton</u>	<u>MCD7010 Function</u>	<u>MLD7020 Function</u>
Review	+10	+10
Seek Down	REVerse	REVerse
Seek Up	FF (Fast Forward)	FF (Fast Forward)
E (Enter)	Pause	Pause
AM		Side A
FM		Side B
ACC On		Power

### Main System Setup Menu

Your McIntosh MX132 has been factory configured for default operating settings that will allow you to immediately enjoy superb video and high fidelity audio without the need for further adjustments.

If you wish to make changes to the factory default settings (refer to the adjacent page), a System Setup Feature is provided to customize the operating settings using On Screen Menus.

*Notes:*

1. To use the on screen menu feature, the MX132 MON A Video Output must be connected to the video input of a Monitor/TV.
2. Any adjustments made to the SPEAKER settings must be performed in the correct sequence, since they are interactive.
3. Any adjustments to reassign ANALOG and DIGITAL INPUTS also must be performed in the correct sequence.
4. Follow the sequence listed in the MAIN SYSTEM SETUP MENU for these adjustments.

1. Press the POWER switch to ON, the Red LED above the STANDBY/ON push-button lights to indicate the MX132 is in Standby mode. To turn on the MX132

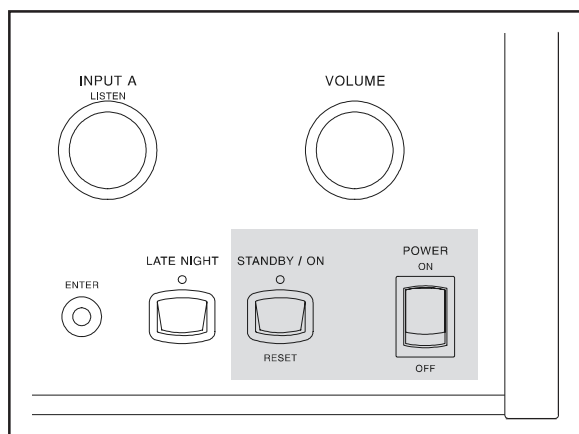

Figure 1



Figure 2

press the STANDBY/ON push-button. The word MUTE will appear on the front panel display for approximately two seconds after turn on. Refer to Figures 1, 2 & 3.

*Note: You may also turn on the MX132 by pressing the POWER pushbutton on the MX132 Remote Control.*

2. Press and hold the MX132 Front Panel Setup pushbutton approximately three seconds to enter the Setup Mode. The SETUP pushbutton will illuminate, the word SETUP will appear on the front panel display and the MAIN SYSTEM SETUP Menu will appear on the Monitor/TV screen. Refer to Figures 4, 5 & 6.
3. Access the desired Setup Menu by pressing the appropriate number pushbutton on the MX132 Remote Control. The desired Setup Menu will then appear on

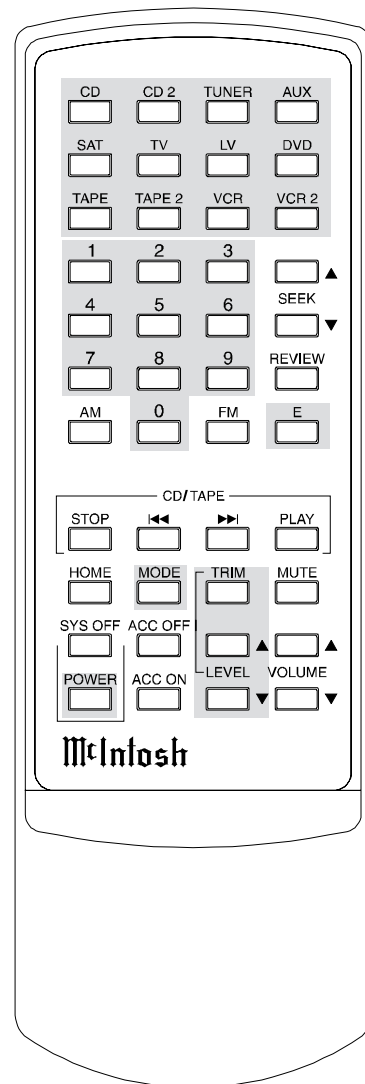

Figure 3

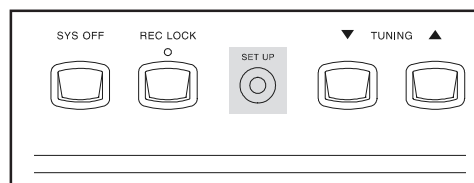

Figure 4

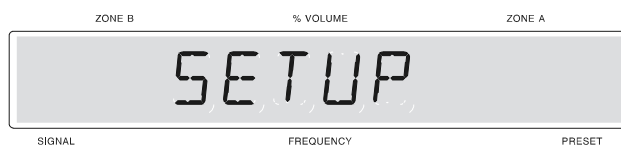

Figure 5

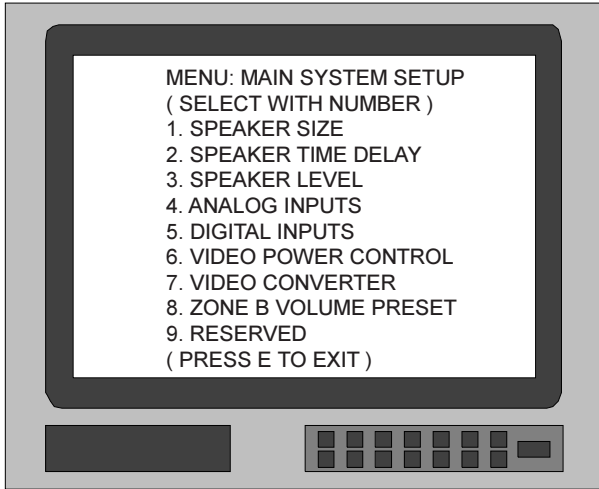

Figure 6

the MONITOR/TV screen for further action. Follow the instructions for each of the setup menus. Refer to Figure 6.

4. After all adjustments are complete, press pushbutton E on the Remote Control to exit from a specific setup menu back to the MAIN SYSTEM SETUP MENU.
5. Press E again to exit from the MAIN SYSTEM SETUP MENU.
6. If adjustments have been performed, the Adjustment Acceptance Menu will appear on the Monitor/ TV screen asking if you want to save the adjustments in memory. Press number 1 for YES to save, or number 0 for NO to not save, and you will exit the Setup Mode back to normal operation. Refer to Figure 7.

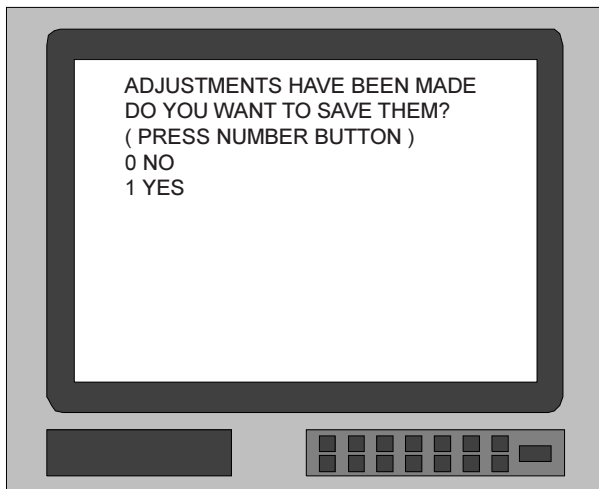

Figure 7

### Default Settings

The following listings indicate the factory default settings. Refer to the listed page number for instructions on how to change a default setting.

#### Speaker Size:

<u>Speaker Type</u>	<u>Size or ON/OFF</u>	<u>Refer to Page</u>
Front .....	Small (THX) .....	23
Center .....	Small (THX) .....	23
SURR .....	Small (THX) .....	23
Subwoofer .....	Yes .....	23
DTS (Full Range)....	OFF .....	23

#### Speaker Time Delay:

<u>Speaker Location</u>	<u>Viewing Distance</u>	<u>Refer to Page</u>
Left Front .....	10 feet .....	24
Center .....	10 feet .....	24
Right Front .....	10 feet .....	24
Right Surr .....	10 feet .....	24
Left Surr .....	10 feet .....	24
Subwoofer .....	10 feet .....	24

#### Speaker Level:

<u>Speaker Location</u>	<u>Initial Level</u>	<u>Refer to Page</u>
Left Front .....	0 .....	26
Center .....	0 .....	26
Right Front .....	0 .....	26
Right Surr .....	0 .....	26
Left Surr .....	0 .....	26
Subwoofer .....	0 .....	26
Bass Limiter .....	Off .....	28

#### Analog Inputs (Zones A and B):

<u>Number</u>	<u>Name</u>	<u>Refer to Page</u>
0 .....	TUN (1*) .....	29
1 .....	AUX (1*) .....	29
2 .....	CD1 .....	29
3 .....	CD2 .....	29
4 .....	TAPE 1 .....	29
5 .....	TAPE 2 .....	29
6 .....	SAT (1*) .....	29
7 .....	TV (1*) .....	29
8 .....	LV (1*) .....	29
9 .....	VCR 1 .....	29
10 .....	VCR 2 .....	29
11 .....	DVD (1*) .....	29

\* Indicates an implied number, which will apply only when a second component of the same type is assigned an input.

### Digital Inputs (Zones A):

<u>Letter</u>	<u>Name</u>	<u>Refer to Page</u>
A .....	CD 1 .....	30
B .....	SAT (1*) .....	30
C .....	LV (1*) .....	30
D .....	CD 2 .....	30
E .....	TV (1*) .....	30
F .....	DVD (1*) .....	30

### Surround Modes (Zones A):

<u>Name</u>	<u>Mode</u>	<u>Refer to Page</u>
TUN (1*) .....	Stereo .....	36
AUX (1*) .....	Stereo .....	36
CD1 .....	Stereo .....	36
CD2 .....	Stereo .....	36
TAPE 1 .....	Stereo .....	36
TAPE 2 .....	Stereo .....	36
SAT (1*) .....	Stereo .....	36
TV (1*) .....	Stereo .....	36
LV (1*) .....	Stereo .....	36
VCR 1 .....	Stereo .....	36
VCR 2 .....	Stereo .....	36
DVD (1*) .....	Stereo .....	36

### Video Input Power Control:

<u>Number</u>	<u>Power Control</u>	<u>Refer to Page</u>
1 .....	ON .....	31
2 .....	ON .....	31
3 .....	ON .....	31
4 .....	ON .....	31
5 .....	ON .....	31
6 .....	ON .....	31
7 .....	ON .....	31
8 .....	ON .....	31
9 .....	ON .....	31
10 .....	ON .....	31
11 .....	ON .....	31

### Video Input Converter:

<u>Number</u>	<u>Conversion</u>	<u>Refer to Page</u>
1 .....	OFF .....	32
2 .....	OFF .....	32
3 .....	OFF .....	32
4 .....	OFF .....	32
5 .....	OFF .....	32
6 .....	OFF .....	32
7 .....	OFF .....	32
8 .....	OFF .....	32
9 .....	OFF .....	32
10 .....	OFF .....	32
11 .....	OFF .....	32

### Audio Functions:

<u>Description</u>	<u>Initial Setting</u>	<u>Refer to Page</u>
Input B Record (Zone B)		
Turn-On-Volume .....	20 .....	33

\* Indicates an implied number, which will apply only when a second component of the same type is assigned an input.

A Home Theater System can include a variety of loudspeakers with various capabilities. The LARGE listing refers to the loudspeaker capability for reproducing bass frequencies down to 35Hz within -3dB of the midrange frequencies. If a loudspeaker can not reproduce bass frequencies down to 35Hz within -3dB of the midrange frequencies it is considered SMALL. If you do not have a subwoofer, you must have front loudspeakers that are LARGE in order to hear the low frequencies below 80Hz. If you are unsure as to the bass performance capabilities of your loudspeakers, select the SMALL THX setting.

1. Press and hold the front panel Setup pushbutton approximately three seconds to enter the Setup Mode. The SETUP pushbutton will illuminate, the word SETUP will appear on the front panel display and the MAIN SYSTEM SETUP MENU will appear on the Monitor/TV screen. Refer to Figure 6.
2. Press pushbutton number 1 on the Remote Control to access the SPEAKER SIZE MENU, which will appear on the Monitor/TV screen. Refer to Figure 8.

*Note: The very first time the SPEAKER SIZE MENU is accessed, the factory default settings will be indicated.*

3. Press number 1 if you wish to change the FRONT loudspeakers from SMALL (THX) to LARGE.
4. Press Remote Control pushbutton numbers 2 and 3 to select and adjust the desired settings for the CENTER and SURROUND loudspeakers to match their low frequency response capabilities.
5. If your system does not include a subwoofer, and the front loudspeakers are LARGE, press Remote Control pushbutton number 4 to change the SUBWOOFER from ON to OFF.
6. Press Remote Control pushbutton number 5 if you wish to change DTS FULL RANGE MODE from OFF to ON. This DTS recommended mode configures all loudspeakers to LARGE.

*Note: Refer to the Owners Manual section on SURROUND MODES for additional operating details.*

7. After all loudspeaker Size adjustments are complete, press pushbutton E on the Remote Control to exit to the MAIN SYSTEM SETUP MENU.

*Note: Continue next to the SPEAKER TIME DELAY adjustments. If you do not wish to perform SPEAKER TIME DELAY adjustments, then proceed to Step 8.*

8. Press E a second time to exit the MAIN SYSTEM SETUP MENU, and the Adjustment Acceptance MENU will appear on the screen. Refer to Figure 7.

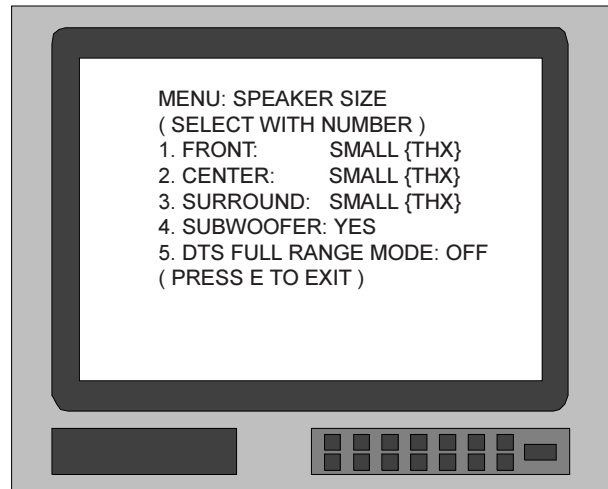

Figure 8

9. If you are satisfied with adjustments or changes you have made, press number 1 on the Remote Control for YES. The changes will be saved in memory and you will exit the Setup Mode to normal operation.
10. If you are not satisfied with the adjustments or changes you have made, press number 0 on the remote control for NO. The Setup Mode will exit to normal operation without saving the changes in memory.

Speaker Size Assignment		
Speaker	Default Setting	New Setting
Front	Small {THX}	
Center	Small {THX}	
Surround	Small {THX}	
Subwoofer	Yes	
DTS Full Range Mode	Off	



### How to Adjust Speaker Time Delay

The ideal Home Theater Listening/Viewing area is defined as facing directly toward the center front loudspeaker, and in line with the left and right surround loudspeakers. The following adjustments will electronically compensate for different distances from the listening/viewing area to each of the loudspeakers.

This feature is referred to as time delay, which involves synchronizing the arrival time of the sound from all six loudspeakers. The loudspeakers nearest to you have their signals delayed to match the sound arrival time of the more distant speakers. The time delay adjustments are based on the distances in feet from each speaker to the Listening/Viewing area and can be adjusted from 5 feet to 50 feet in one foot increments.

*Note: Before performing the TIME DELAY adjustments, you must first have completed the SPEAKER SIZE adjustments.*

1. Press and hold the front panel Setup pushbutton approximately three seconds to enter the Setup Mode. The SETUP pushbutton will illuminate, the word SETUP will appear on the front panel display and the MAIN SYSTEM SETUP MENU will appear on the Monitor/TV screen. Refer to Figures 5 & 6.

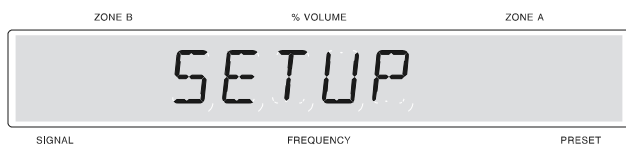

Figure 5

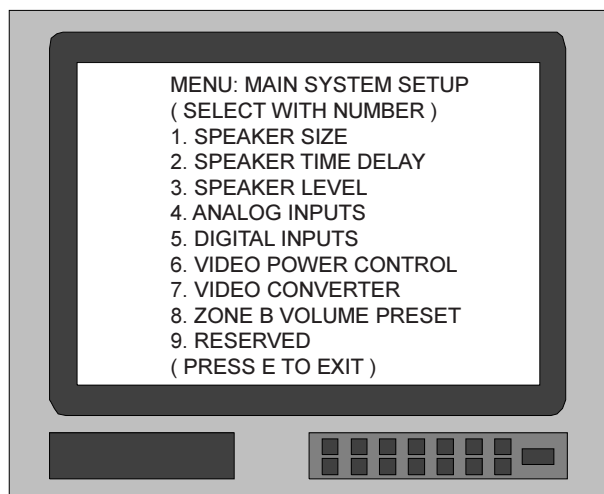

Figure 6

2. Press Number 2 pushbutton on the Remote Control to access the SPEAKER TIME DELAY MENU, which will appear on the Monitor/TV screen. Refer to Figures 3 & 9.

*Note: The very first time the SPEAKER TIME DELAY MENU is accessed, the screen will indicate the factory default settings.*

3. Measure the distance from the Listening/Viewing area to each of the loudspeakers. Refer to Figure 10.

*Note: A distance measurement that is not an even number of feet, should be rounded off to the nearest whole number for this procedure.*

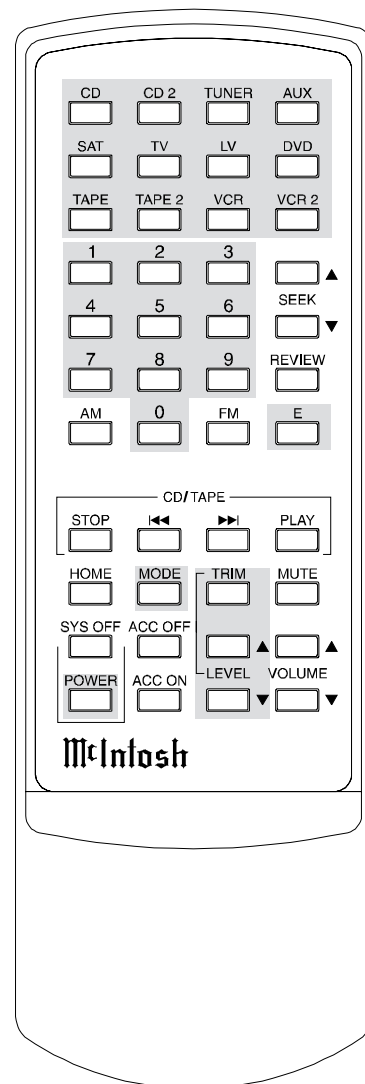

Figure 3



Figure 9

4. Press Number 1 pushbutton on the Remote Control to access the LEFT FRONT loudspeaker to start the process. The distance indication for the Left Front loudspeaker will blink on and off.

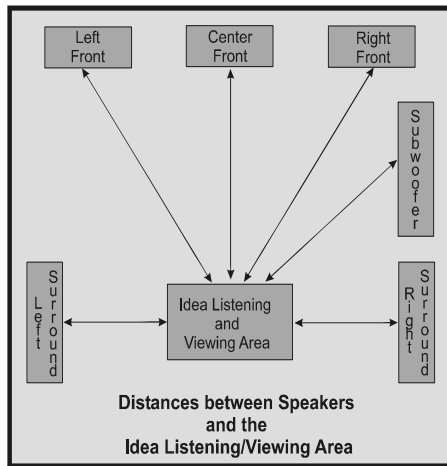

Figure 10

5. Press the LEVEL Up or Down pushbutton on the Remote Control until the LEFT FRONT distance reading on the screen is the same as the measured Left Front loudspeaker distance. The Left Front loudspeaker will now be Time Delay Synchronized.
6. Press the appropriate number pushbutton on the Remote Control to access each of the remaining loudspeakers and repeat the TIME DELAY Synchronizing process.
7. After all loudspeaker Time Delay Synchronizing distance adjustments are complete, press pushbutton E on the Remote Control to exit to the MAIN SYSTEM SETUP MENU.

*Note: After completing the SPEAKER TIME DELAY adjustments, continue to the SPEAKER LEVEL adjustments. If you do not wish to perform SPEAKER LEVEL adjustments at this time, proceed to steps 8, 9 and 10.*

8. Press pushbutton E a second time to exit the MAIN SYSTEM SETUP MENU and the Adjustment Acceptance screen will appear. Refer to Figure 7.
9. If you are satisfied with adjustments or changes you have made, press number 1 on the Remote Control for YES. The changes will be saved in memory and you will exit the Setup Mode to normal operation.
10. If you are not satisfied with the adjustments or changes you have made, press number 0 on the remote control for NO. The Setup Mode will exit to normal operation without saving the changes in memory.

Speaker Time Delay		
Speaker	Default Setting	New Setting
Left Front	10ft	
Center	10ft	
Right Front	10ft	
Right Surround	10ft	
Left Surround	10ft	
Subwoofer	10ft	

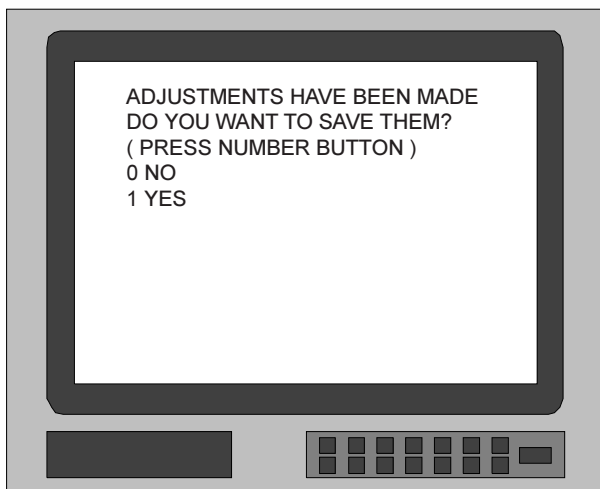

Figure 7

### How to Adjust Speaker Levels

A properly setup Home Theater surround sound system should have all loudspeaker levels adjusted to the same starting reference volume level in the Listening/Viewing area. This ensures that multi-channel sound tracks will be reproduced with optimum realism. Individual channel levels from an actual sound track usually change on a continuous basis.

*Note: Before performing the SPEAKER LEVEL adjustments, you FIRST must have performed the SPEAKER SIZE and TIME DELAY adjustments. You will be able to make temporary level changes using the TRIM feature to compensate for variations in program material. The temporary changes will be erased, for certain Surround Modes, when the MX132 is turned off.*

The MX132 System Setup program includes a built-in test signal generator, which can have its output switched into each loudspeaker, either automatically or manually. The starting test signal generator volume is set to the THX recommended level of 75dB sound pressure level. The desired test signal volume levels of each loudspeaker can be determined, in the Listening/Viewing area, either by listening or with a sound pressure meter. Level adjustments are made in small steps (1 dB) by using the MX132 Remote Control LEVEL pushbuttons. The level can be adjusted over a plus or minus 12dB range.

*Note: The MX132 also includes a Bass Limiter circuit, which can be turned on to limit the maximum level of bass energy fed to the subwoofer or any large full range loudspeakers.*

1. Press and hold the front panel Setup pushbutton approximately three seconds to enter the Setup Mode. The SETUP pushbutton will illuminate, the word SETUP will appear on the front panel display and the MAIN SYSTEM SETUP MENU will appear on the Monitor/TV screen. See Figure 6.
2. Press number 3 on the Remote Control to access the SPEAKER LEVEL MENU, which will appear on the Monitor/TV screen. See Figure 11.

*Note: The very first time the SPEAKER LEVEL MENU is accessed, the screen will indicate the factory default settings.*

3. Determine whether you wish to use the Automatic or Manual loudspeaker Level switching mode. For Automatic switching, proceed to Step 4. For manual switching proceed to Step 14.

*Note: The front panel Output Format LED's will light to indicate which loudspeaker is receiving the test signal. Refer to Figure 12.*

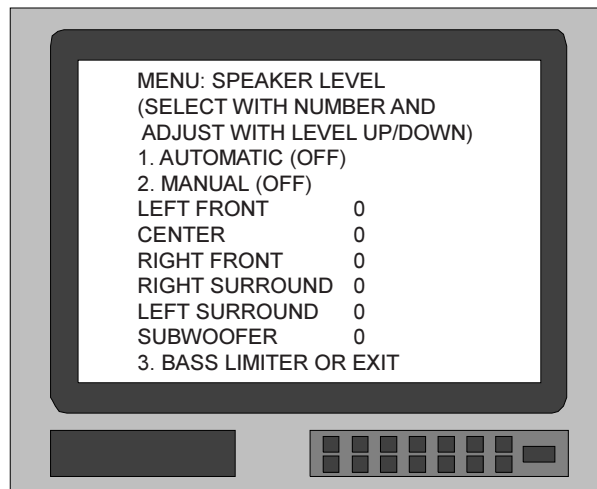

Figure 11

### Automatic Loudspeaker Level Switching

4. Press number 1 pushbutton on the Remote Control and the screen will indicate AUTOMATIC (ON). The test signal will start cycling continuously through all loudspeakers in 2-second intervals. The Level number for the specific loudspeaker being adjusted will blink on and off.
5. While in the Listening/Viewing area, note the volume levels from each of the loudspeakers as the test signal switches. If you determine that the test signal volume is louder or softer in any of the loudspeakers, the levels should be adjusted so you hear the same test signal volume from all of the loudspeakers

*Note: The Left Front Loudspeaker volume level can serve as a reference. The THX recommended level is 75dB as indicated on a sound pressure level meter.*

6. Adjust the volume of the test signal by pressing a LEVEL Up or Down pushbutton on the Remote Control. If an adjustment is made on a loudspeaker, there is an additional 2-second time interval before the system switches to the next loudspeaker. As a level is changed, the on screen display instantly indicates the level change. If the level is increased or decreased, the display will indicate numbers or minus numbers.

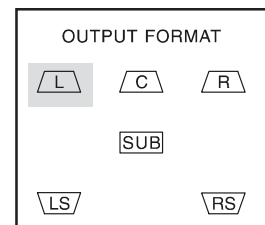

Figure 12

7. As the test signal switches to succeeding loudspeakers, repeat the level adjustment process until the test signal volume levels of all the loudspeakers are the same. The loudspeaker level cycling mode can be repeated as often as necessary.

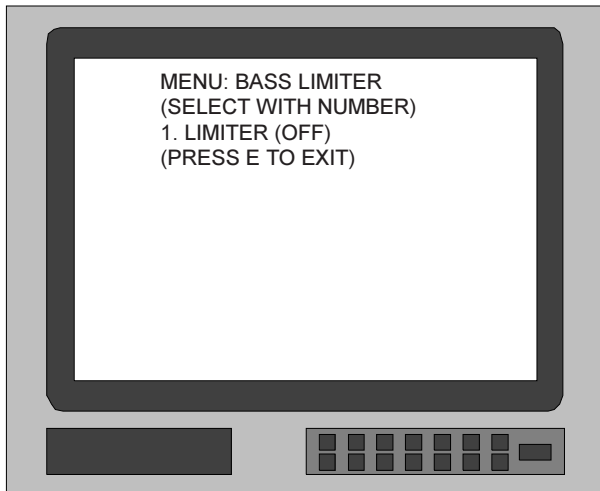

Figure 13

*Note: Before performing the BASS LIMITER calibration, you FIRST must have performed the SPEAKER SIZE, SPEAKER TIME DELAY and SPEAKER LEVEL adjustments.*

8. Press Remote Control pushbutton 3 to access the BASS LIMITER MENU.
- Note: The factory default setting for the BASS LIMITER is OFF.*
9. Press pushbutton number 1 to access the BASS LIMITER SETUP MENU and follow the BASS LIMITER SETUP instructions.
10. If you do not wish to continue with the BASS LIMITER SETUP, press pushbutton E on the Remote Control to exit to the MAIN SYSTEM SETUP MENU.
11. Press E a second time to exit the MAIN SYSTEM SETUP MENU and the Adjustment Acceptance MENU will appear on the Monitor/TV screen. Refer to Figure 7.
12. If you are satisfied with the SPEAKER LEVEL adjustments you have made, press Remote Control pushbutton number 1 for YES. The changes will be saved in memory and you will exit the Setup Mode to normal operation.
13. If you are not satisfied with the adjustments or changes you have made, press number 0 on the remote control for NO. The Setup Mode will exit to normal operation without saving the changes in memory.

*Note: If no adjustments were made, Press Remote Control pushbutton E to exit to the MAIN SYSTEM SETUP MENU and Press E a second time to exit the Setup mode back to normal operation. The Acceptance Menu will not appear.*

### Manual Speaker Level Switching

14. Press pushbutton number 2 on the Remote Control to start manual loudspeaker switching, the Monitor/TV screen will indicate MANUAL (ON) and the LEFT FRONT Level number will blink on and off.
15. Adjust the volume of the test signal by pressing a Remote Control LEVEL Up or Down pushbutton. As a level is changed, the Monitor/TV screen instantly indicates the level change. If the level is increased or decreased, the display will indicate numbers or minus numbers.

*Note: The Left Front Loudspeaker volume level can serve as a reference. The THX recommended level is 75dB as indicated on a sound pressure level meter.*

16. Press number 2 again on the MX132 Remote Control and the CENTER level number will blink on and off.
17. Repeat Step 15 to adjust the level of the CENTER loudspeaker.
18. Press 2 each time you wish to advance to the next loudspeaker and repeat Step 15.
19. Repeat the level adjusting procedure as often as necessary until you are satisfied that the volume levels are the same from all of the loudspeakers.

*Note: Before performing the BASS LIMITER calibration, you FIRST must have performed the SPEAKER SIZE, SPEAKER TIME DELAY and SPEAKER LEVEL adjustments.*

20. Press Remote Control pushbutton 3 to access the BASS LIMITER MENU.
- Note: The factory default setting for the BASS LIMITER is OFF.*
21. Press pushbutton number 1 to access the BASS LIMITER SETUP MENU and follow the BASS LIMITER SETUP instructions.
22. If you do not wish to continue with the BASS LIMITER SETUP, press pushbutton E on the Remote Control to exit to the MAIN SYSTEM SETUP MENU
23. Press E a second time to exit the MAIN SYSTEM SETUP MENU and the Adjustment Acceptance MENU will appear on the Monitor/TV screen. Refer to Figure 7.
24. If you are satisfied with the SPEAKER LEVEL adjustments you have made, press Remote Control pushbutton number 1 for YES. The changes will be saved in memory and you will exit the Setup Mode to normal operation.

25. If you are not satisfied with the adjustments or changes you have made, press number 0 on the remote control for NO. The Setup Mode will exit to normal operation without saving the changes in memory.

Speaker Level		
Speaker	Default Setting	New Setting
Left Front	0	
Center Front	0	
Right Front	0	
Right Surround	0	
Left Surround	0	
Subwoofer	0	

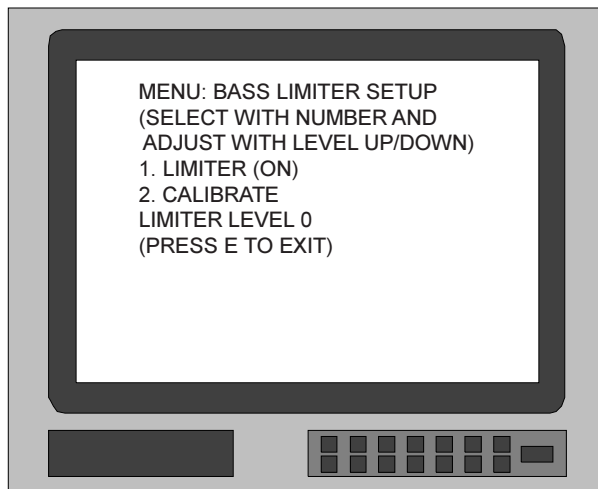

Figure 14

### How to Adjust the Bass Limiter

Multi-channel sound tracks from contemporary action movies and other digital music sources can include intense low frequency bass sound effects and energy. Damage to your subwoofer or other large full range speakers could occur during extremely loud passages. The BASS LIMITER feature protects your loudspeakers by allowing you to determine the maximum safe bass levels, and keep the system from exceeding these safe volume levels. Follow the instructions below to calibrate the BASS LIMITER.

*Note: Before performing the BASS LIMITER calibration, you FIRST must have performed the SPEAKER SIZE, SPEAKER TIME DELAY and SPEAKER LEVEL adjustments.*

1. Press Remote Control pushbutton number 3, to access the BASS LIMITER MENU from the SPEAKER LEVEL MENU.

*Note: The very first time the BASS LIMITER MENU is accessed, the factory default setting of LIMITER LEVEL 0 will be indicated on the screen.*

2. Press pushbutton 1 to access the BASS LIMITER SETUP MENU.
3. Press pushbutton 1 a second time to select LIMITER ON.
4. Press pushbutton number 2 to access the Limiter calibration mode. Refer to Figure 14

**CAUTION:** Use extreme care when performing the next steps to CALIBRATE THE BASS LIMITER to prevent possible loudspeaker damage.

5. Press a LEVEL Up pushbutton the remote Control until the test signal becomes audible from your subwoofer. If you have no subwoofer, the test signal will be audible from your other Large loudspeakers.
6. Using the LEVEL Up pushbutton, gradually increase the test signal volume level until you detect evidence that the subwoofer or other Large loudspeakers are reaching their limit of undistorted output. An indication that the loudspeakers are approaching their limit, is a change in the sound character of the test signal.
7. Press pushbutton E to exit the BASS LIMITER SETUP. The BASS LIMITER function will be turned ON and the maximum bass volume level will never exceed the level reached in Step 6. You will also exit to the MAIN SYSTEM SETUP MENU.
8. Press E a second time to exit the MAIN SYSTEM SETUP MENU and the Adjustment Acceptance MENU will appear on the screen. Refer to Figure 7
9. If you are satisfied with adjustments you have made, press number 1 on the Remote Control for YES. The changes will be saved in memory and you will exit the Setup Mode to normal operation.
10. If you are not satisfied with the adjustments or changes you have made, press number 0 on the remote control for NO. The Setup Mode will exit to normal operation without saving the changes in memory.

Bass Limiter		
Speaker	Default Setting	New Setting
Subwoofer	OFF	



### How to Reassign the Analog Inputs (Audio and Video)

The MX132 Setup mode allows any of the eleven Analog inputs to be reassigned to a different source indication and number. Whenever the Zone A or Zone B Input Selector switches to the newly assigned input source, it will be indicated on the front panel display. For example, AUX1 can be reassigned as DVD2. When the Input selectors are turned to select what originally was AUX1, DVD2 will appear on the front panel display. Inputs can also be turned Off, and will no longer appear as an available input when an input is selected with the remote Control or a front panel Input switch.

- Notes: 1. Analog Inputs must be reassigned first, before reassigning the matching Digital inputs.  
2. The Tuner input source is fixed and cannot be changed.*

1. Press and hold the front panel Setup pushbutton approximately three seconds to enter the Setup Mode. The SETUP pushbutton will illuminate, the word SETUP will appear on the front panel display and the MAIN SYSTEM SETUP MENU will appear on the Monitor/TV screen. Refer to Figure 6.
2. Press 4 on the Remote Control to enter the ANALOG INPUT MENU, which will appear on the Monitor/TV screen. Refer to Figure 15.

*Note: The very first time the ANALOG INPUT Menu is accessed, the screen will indicate the factory default settings.*

**EXAMPLE:** The following example, which describes how to reassign AUX1 to DVD2, is the procedure to use for any Analog input reassignment.

3. Press a LEVEL Up or Down pushbutton on the Remote Control until AUX1 blinks on and off.
4. Press pushbutton DVD, and then the number 2 on the Remote Control. AUX1 will be replaced with DVD2 on the menu. The front panel display will change to indicate DVD2 instead of AUX1.

*Note: Inputs must be assigned with increasing numbers. For example, you must assign DVD2 before DVD3.*

5. Press a Level pushbutton to select the next input you wish to reassign, the new source pushbutton and the desired number pushbutton. Repeat this procedure as desired.

*Note: Input reassignments are done only with the non-numbered input pushbuttons.*

6. After all Analog Input reassignments are complete, Press E on the Remote Control to exit to the Main System Setup Menu.

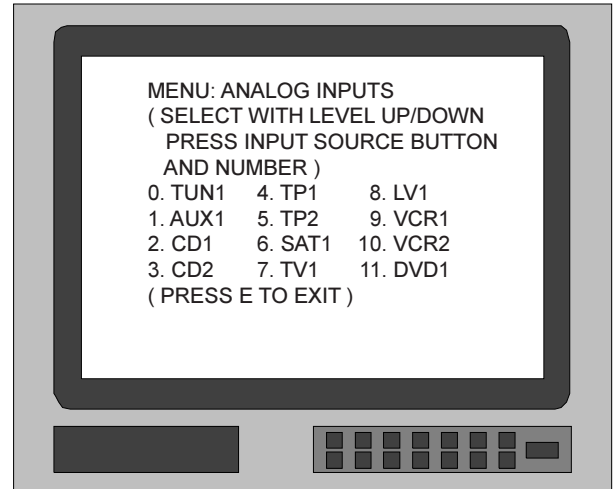

Figure 15

7. Press E a second time to exit the Main System Setup mode and the Adjustment Acceptance menu will appear on the screen. Refer to Figure 7
8. If you are satisfied with adjustments (reassignments) you have made, Press 1 for YES. The changes will be saved in memory and you will exit the Setup Mode.
9. If you are not satisfied with the adjustments or changes you have made, press number 0 on the remote control for NO. The Setup Mode will exit to normal operation without saving the changes in memory.

Analog Input Assignment		
Input Number	Default Setting	New Setting
1	AUX1	
2	CD1	
3	CD2	
4	TAPE1	
5	TAPE2	
6	SAT1	
7	TV1	
8	LV1	
9	VCR1	
10	VCR2	
11	DVD1	

### How to Reassign the Digital Inputs

The Setup Mode allows reassignment any of the six digital inputs. If an analog/digital input match exists, the digital input will automatically track the analog input change. If there is no analog/digital input match, one of the existing digital inputs must then be reassigned to match the analog input.

*Note: An analog Input must already exist before a digital Input can exist. Refer to the ANALOG INPUT instructions to reassign AUX1 to DVD2.*

**EXAMPLE:** How to reassign AUX1 as DVD2 digital.

1. Press and hold the front panel Setup pushbutton approximately three seconds to enter the Setup Mode. The SETUP pushbutton will illuminate, the word SETUP will appear on the front panel display and the MAIN SYSTEM SETUP MENU will appear on the Monitor/TV screen. Refer to Figure 6.
2. From the MAIN SYSTEM SETUP MENU, press 5 to access the DIGITAL INPUT MENU. Refer to Figure 16.

*Note: The very first time the DIGITAL INPUT MENU is accessed, the factory default settings of all Digital inputs will be displayed, unless analog input changes have been made.*

3. Since AUX1 did not have a matching digital input, in this example, digital TV1 can be changed to digital DVD2. Press a LEVEL Up or Down pushbutton on the Remote Control until digital TV1 blinks on and off.

*Note: Input reassignments are done only with non-numbered Remote Control Input Pushbuttons. Assigned numbers are entered with the number pushbuttons.*

4. Press pushbutton DVD and then the number 2 on the Remote Control, TV1 will be replaced with DVD2 on the menu screen.
5. After completing the reassignment, press E on the Remote Control to exit to the MAIN SYSTEM SETUP MENU.
6. Press E a second time to exit the MAIN SYSTEM SETUP MENU and the Adjustment Acceptance MENU will appear on the Monitor/TV screen. Refer to Figure 7.
7. If you are satisfied with adjustments you have made, press Remote Control pushbutton number 1 for YES. The changes will be saved in memory and you will exit the Setup Mode to normal operation.
8. If you are not satisfied with the adjustments or changes you have made, press number 0 on the remote control for NO. The Setup Mode will exit to normal operation without saving the changes in memory.

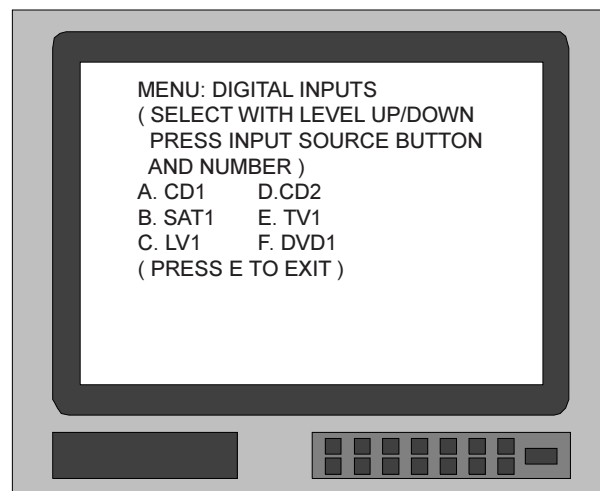

Figure 16

*Note: When a digital input is assigned and selected a dot appears after the ZONE A Input source on the front panel display. Refer to Figure 17.*

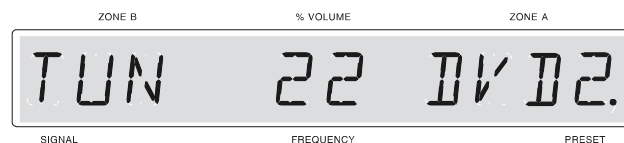

Figure 17

### Turning Off a Digital Input

If you should desire to turn off an existing digital audio input and use only the analog input, follow the instructions below.

1. Press a LEVEL Up or Down pushbutton to select the digital input you wish to turn Off.
2. Press pushbutton 0 to turn the input off (press the same input again to turn the input back on).
3. Repeat Steps 5, 6, 7 and 8.

Digital Input Assignment		
Input Letter	Default Setting	New Setting
A	CD1	
B	SAT1	
C	LV1	
D	CD2	
E	TV1	
F	DVD1	

### How to Assign Video the Power Control

The MX132 VIDEO POWER CONTROL Setup allows you to configure any Video Input to automatically turn on the Video AC outlets on a McIntosh PC-3 Power Control when that Input is selected. A video accessory component with its power cord connected to the PC-3 Video outlet will then receive power when the input is selected.

1. Press and hold the front panel Setup pushbutton approximately three seconds to enter the Setup Mode. The SETUP pushbutton will illuminate, the word SETUP will appear on the front panel display and the MAIN SYSTEM SETUP MENU will appear on the Monitor/TV screen. Refer to Figure 6.

*Note: The Video Power Control Setup Menu display includes a "0" input which corresponds to TUNER. If this input is configured to ON, the Video AC outlets on a PC-3 will turn on whenever the Tuner is selected.*

2. Press pushbutton number 6 on the Remote Control to access the VIDEO POWER CONTROL MENU, which will appear on the Monitor/TV screen. Refer to Figure 18.

*Note: The very first time the VIDEO POWER CONTROL MENU is accessed, the screen will indicate the factory default settings.*

3. Press a LEVEL Up or Down pushbutton on the Remote Control until the Input you wish to configure Power Control blinks on and off.
4. Press the Mode pushbutton on the Remote Control to cycle the VIDEO POWER CONTROL ON or OFF.
5. Repeat Steps 3 and 4 to configure as many video inputs as you desire.
6. After all Video Input control adjustments are complete, press pushbutton E on the Remote Control to exit to the MAIN SYSTEM SETUP MENU.
7. Press E a second time to exit the MAIN SYSTEM SETUP MENU and the Adjustment Acceptance MENU will appear on the Monitor/TV screen. Refer to Figure 7.
8. If you are satisfied with adjustments you have made, press Remote Control pushbutton number 1 for YES. The changes will be saved in memory and you will exit the Setup Mode to normal operation.
9. If you are not satisfied with the adjustments or changes you have made, press number 0 on the remote control for NO. The Setup Mode will exit to normal operation without saving the changes in memory.

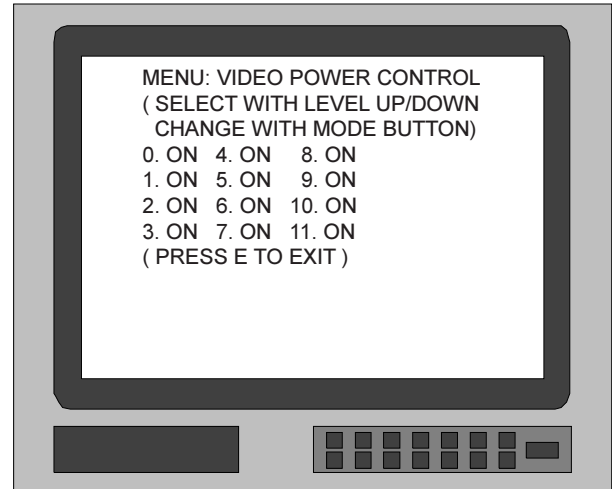

Figure 18

Video Power Assignment		
Input Number	Default Setting	New Setting
0	ON	
1	ON	
2	ON	
3	ON	
4	ON	
5	ON	
6	ON	
7	ON	
8	ON	
9	ON	
10	ON	
11	ON	

*Note: The very first time the DIGITAL INPUT MENU is accessed, the factory default settings of all Digital inputs will be displayed, unless analog input changes have been made.*

### How to Assign the Video Converter

The MX132 Video Converter feature allows you to configure any Composite input signal to be converted to an “S” signal that will appear at the Zone A “S” Video Output. This allows accessory video components that only have Composite outputs to be used together with components that have “S” outputs and have both types of video signals available at the MX132 “S” Video Output. The Composite signals will still appear at the Composite Video Output.

1. Press and hold the front panel Setup pushbutton approximately three seconds to enter the Setup Mode. The SETUP pushbutton will illuminate, the word SETUP will appear on the front panel display and the MAIN SYSTEM SETUP MENU will appear on the Monitor/TV screen. See Figure 6.

*Note: The Video Converter Setup Menu display includes a “0” input which corresponds to Tuner, that does not have a matching video input. This was included in the On Screen menu only to maintain a display consistency. See Figure 19. The Video Converter Assignment Chart therefor does not include this input.*

2. Press pushbutton number 7 on the Remote Control to access the VIDEO CONVERTER MENU, which will appear on the Monitor/TV screen. See Figure 19.

*Note: The very first time the VIDEO CONVERTER MENU is accessed, the screen will indicate the factory default settings.*

3. Press a LEVEL Up or Down pushbutton on the Remote Control until the Input you wish to convert blinks on and off.
4. Press the Mode pushbutton on the Remote Control to cycle the converter ON or Off.
5. Repeat Steps 3 and 4 to convert as many video inputs as you desire.
6. After all Video Input conversions adjustments are complete, press pushbutton E on the Remote Control to exit to the MAIN SYSTEM SETUP MENU.
7. Press E a second time to exit the MAIN SYSTEM SETUP MENU and the Adjustment Acceptance MENU will appear on the Monitor/TV screen. Refer to Figure 7.
8. If you are satisfied with adjustments you have made, press Remote Control pushbutton number 1 for YES. The changes will be saved in memory and you will exit the Setup Mode to normal operation.

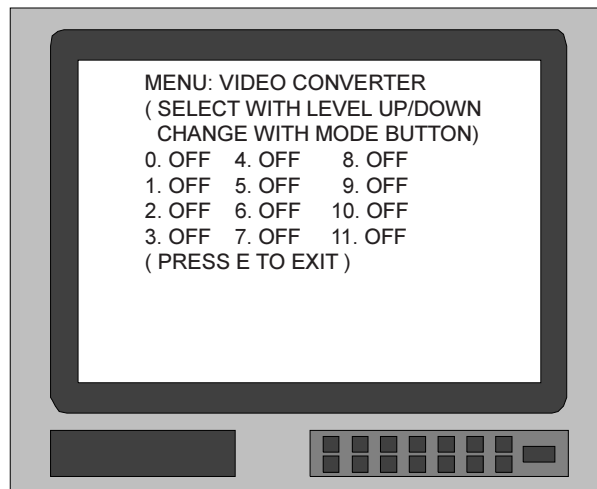

Figure 19

9. If you are not satisfied with the adjustments or changes you have made, press number 0 on the remote control for NO. The Setup Mode will exit to normal operation without saving the changes in memory.

Video Converter Assignment		
Input Number	Default Setting	New Setting
1	OFF	
2	OFF	
3	OFF	
4	OFF	
5	OFF	
6	OFF	
7	OFF	
8	OFF	
9	OFF	
10	OFF	
11	OFF	

## How to Adjust Zone B Volume Preset and Optimize AM Reception

### How to Adjust Zone B Volume Preset

The MX132 Setup program allows you to set the wakeup Volume Level for Zone B. The level is expressed in percentage of maximum available volume.

1. Press and hold the front panel Setup pushbutton approximately three seconds to enter the Setup Mode. The front panel display will indicate SETUP and the MAIN SYSTEM SETUP MENU will appear on the Monitor/TV screen. Refer to Figure 6.
2. Press Number 8 pushbutton on the Remote Control to access ZONE B VOLUME PRESET MENU, which will appear on the screen. Refer to Figure 20.

*Note: The very first time the ZONE B VOLUME PRESET MENU is accessed, the screen will indicate the factory default settings.*

3. Press a Level Up or Down pushbutton for the desired Zone B Volume Preset level.
4. After the ZONE B VOLUME PRESET has been adjusted, press pushbutton E on the Remote Control to exit to the MAIN SYSTEM SETUP MENU.
5. Press E a second time to exit the MAIN SYSTEM SETUP MENU and the Adjustment Acceptance screen will appear. Refer to Figure 7.
6. If you are satisfied with adjustments you have made, press Remote Control pushbutton number 1 for YES. The changes will be saved in memory and you will exit the Setup Mode to normal operation.
7. If you are not satisfied with the adjustments or changes you have made, press number 0 on the remote control for NO. The Setup Mode will exit to normal operation without saving the changes in memory.

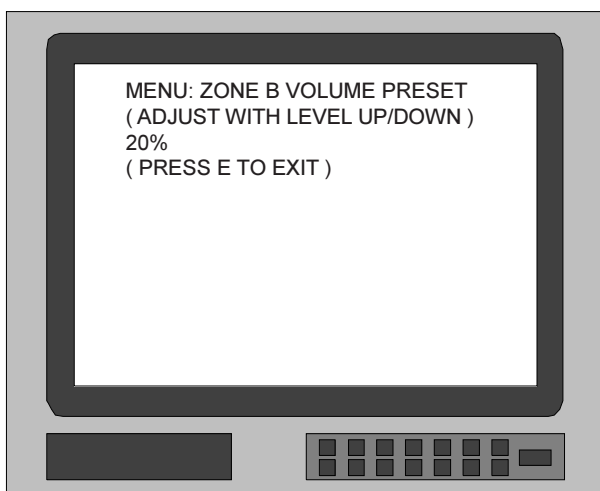

Figure 20

### How to Optimize AM Reception

The McIntosh RAA1 Remote Antenna is designed to improve the AM reception in any installation, especially if the tuner or A/V unit is located in a noisy reception area. Place the RAA1 away from all interference sources such as AC power cords and florescent lights, etc. Rotate the antenna in any direction necessary to reduce interference and receive maximum signal strength.

*Notes:*

1. The RAA1 Remote AM Antenna of your MX132 has been factory adjusted for optimum reception in a typical urban location. If you wish to customize the antenna for the best possible performance in your location, have your installer perform the two adjustment operations listed below.
2. An additional long line AM antenna or external ground can be connected to the GND and ANT terminals if desired.
3. Refer to Tuner Functions in the How to Operation the AM/FM Tuner Section of this Owner's Manual when performing the following steps.

1. Tune to a weak AM station near 600kHz on the AM band. Using a small **NON - METALLIC** screwdriver, adjust the 600kHz transformer L1 for maximum signal strength. Refer to Figure 21.

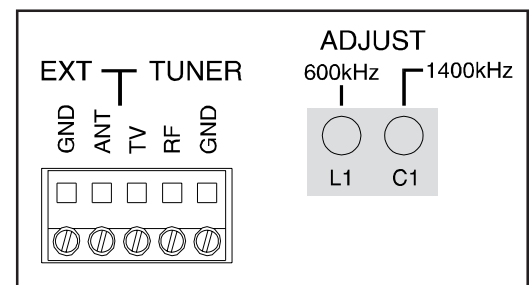

Figure 21

2. Tune to a weak AM station near 1400kHz on the AM band. Using a small **NON-METALLIC** screwdriver, adjust the 1400kHz capacitor trimmer C1 for maximum signal strength.



Your McIntosh MX132 has been factory configured for default operating settings that will allow you to immediately enjoy superb video and high fidelity audio without the need for further adjustments. If you wish to make changes to the factory default settings refer to the SETUP Section of this Owners Manual.

### Power On and Off

Press the POWER switch to ON. The Red LED above the STANDBY/ON push-button lights to indicate the MX132 is in Standby mode. To turn on the MX132 press the STANDBY/ON push-button. The word MUTE will appear on the front panel display for approximately two seconds after turn on. Refer to Figures 22 & 23.

*Note: You may also turn on the MX132 by pressing the POWER pushbutton on the MX132 Remote Control.*



Figure 22

### System Off

Normally remote zone(s) are turned on and off individually in each respective zone by pressing the Power push-button on a keypad or remote control. If you desire to turn off all zones of an entire McIntosh System simultaneously, including a control center and accessory source components, you can press the Sys Off push-button on the front panel. Refer to figure 23.

*Note: You can also turn off the entire system in any remote zone by pressing the Sys Off push-button on a keypad or remote control.*

### Reset of Microprocessors

In the event that the controls of the MX132 stop functioning, there is a user reset function built in. While the MX132 is on, depress and hold in the STANDBY/ON/RE-

SET push button for five seconds. This will reset the MX132 microprocessors. Refer to figure 23.

*Note: The above condition is usually caused by either interruptions in AC power and/or major changes in voltage.*

### Volume Control and Volume Level Display

Adjust the Volume control to select the desired level in Zone A (Listen). The Volume control adjusts all six channels simultaneously, and level is indicated from 0 to 99 in the center of the front panel display. Zone B is not affected by the front panel Volume control. Zone B (Record) volume level is adjusted only in Zone B with a Remote Control or keypad. Refer to figure 23.

### Input A and B Selector

The Input A Selector Switch selects the program signal source for Zone A. The selected source is indicated on the right side of the front panel display. Input B Selector Switch selects the program signal source for Zone B, the Tape Outputs and VCR outputs. The selected source is indicated on the left side of the front panel display. Refer to figure 23.

### Late Night

The LATE NIGHT push-button turns a volume compression circuit on and off. This feature suppresses loud sounds or music that might disturb neighbors or others not in the immediate area of the home theater. Soft levels are also raised slightly so they are still listenable at reduced overall volume levels. This works only on a Dolby Digital sound track with encoded data that supports the compression function. Refer to figure 23.

### Front Panel Status LED's

The three sets of front panel LED's indicate the status of Input Format, Operating/Decoding Modes and the Output Format. Refer to figure 24.

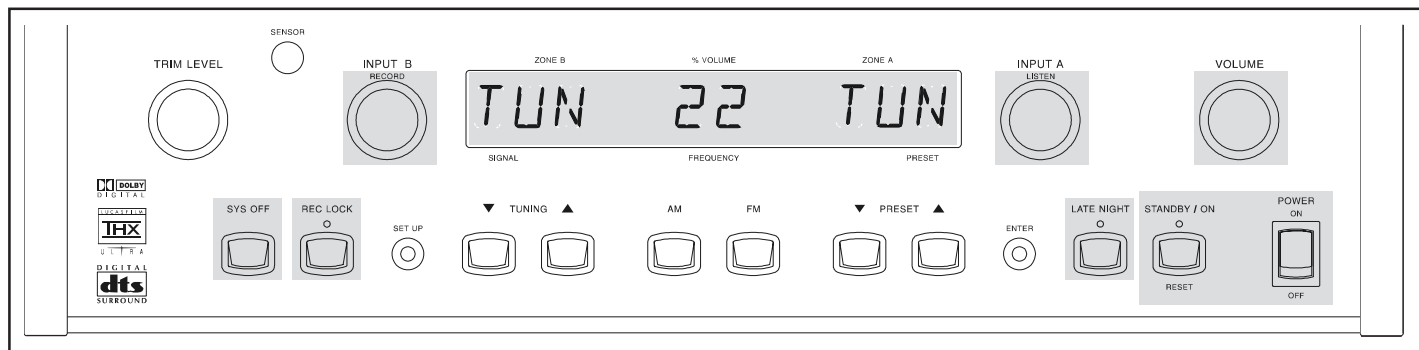

Figure 23



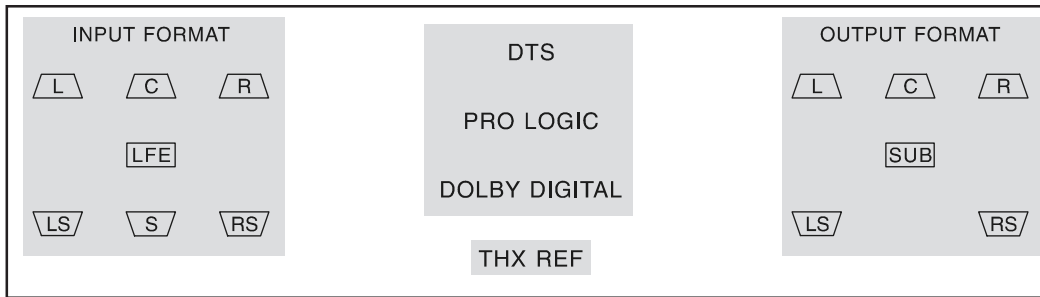

Figure 24

*Note: If a Digital Input is selected and the Digital Source Component is not producing an output signal, none of the Front Panel Status LED's will illuminate.*

#### Input Format

- A. If the input signal source is Six Channel Discrete, the front panel INPUT FORMAT LED's L, C, R, LFE, LS and RS will illuminate.
- B. If a Digital input signal source is 2 channel Surround Encoded, the front panel INPUT FORMAT LED's L, R and S will illuminate.  
*Note: This will only occur when the SURROUND MODE is in CINEMA or THX CINEMA.*
- C. If the input signal source is two channel, the INPUT FORMAT LED's L and R will illuminate.
- D. If an Analog input signal source is Mono, both channels will be receiving the mono signal and the INPUT FORMAT LED's L and R will illuminate.

#### Operating Mode Displays

- E. The DTS display will illuminate when the input contains DTS encoded signals.
- F. The PRO LOGIC display will illuminate when the Surround Mode Selector is turned to CINEMA or THX CINEMA and the Input signal is Dolby Surround Encoded.
- G. The DOLBY DIGITAL display will illuminate when the input contains Dolby Digital encoded signals.
- H. The THX REF (Reference) display will illuminate when the Volume control is set to the THX level. The THX default volume level is 65%, but it will change if levels are adjusted up or down in the SPEAKER LEVEL Setup.

#### Output Format:

- I. The OUTPUT FORMAT LED's indicate the SURROUND MODE selected and the active audio channels.
- J. STEREO mode will cause the L, R and SUB LED's to light.

K. MUSIC 1, 2, 3, CINEMA, THX CINEMA and EXTERNAL will cause the L, C, R, SUB, LS and RS to light.

L. MONO will cause the C and SUB LED's to light.

*Note: If the Subwoofer is set to OFF in the SPEAKER SIZE setup, the SUB LED will not light in any Output Format.*

#### **How To Make A Tape Recording**

The separate INPUT B RECORD and INPUT A LISTEN switches allow you to make a tape recording from one program source while listening to another. You can also listen (monitor) to the recorded signal off the tape, a fraction of a second later, during recording when a three head tape recorder is used. Refer to figure 23.

1. Press the REC LOCK (Record Lock) pushbutton to disable any Zone B sensors or keypads to avoid a Zone B selection interfering with the recording process in Zone A.
- Note: If there is no Zone B connected in your system this step can be omitted.*
2. Select the desired program source to record with the front panel INPUT B RECORD selector switch.
3. Adjust the record level using the tape recorder volume control.
4. To monitor the tape during recording with a three head tape recorder, or playback the tape just recorded, turn the INPUT A LISTEN switch to select the recorder used to make the tape.

*Note: The MX132 RECORD OUTPUTS are not affected by the VOLUME control. To listen to a different program source while recording, turn the LISTEN switch to the desired source. The recording process will not be affected and will continue.*

### How to Operate the FM Tuner

The McIntosh MX132 incorporates an advanced design FM tuner with many desirable performance features to enhance your enjoyment of radio broadcasts. There are four methods of tuning to an FM broadcast station. These are Manual, Automatic Preset Review, Preset pushbutton search and Direct Preset number access with the Remote Control.

### How to tune FM Stations Manually

1. Select TUNER with the front panel INPUT A switch or the Remote Control TUNER pushbutton. Refer to Figures 25 & 26.

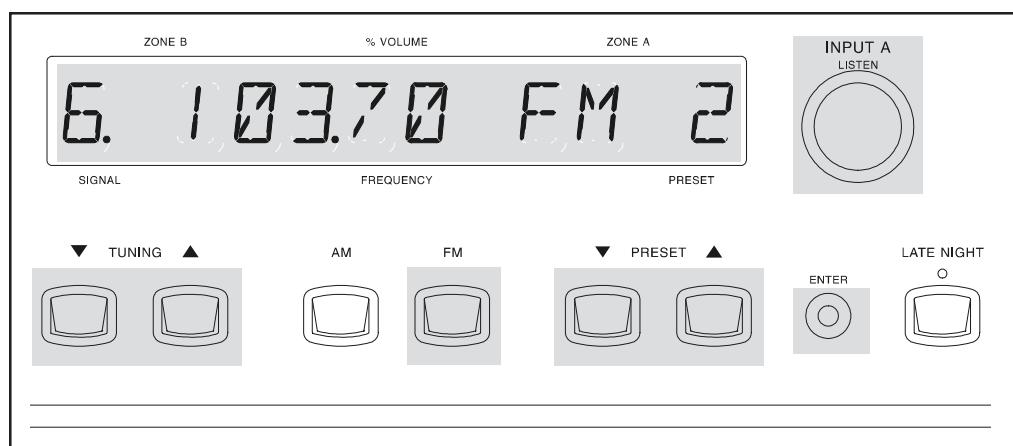

Figure 25

2. Select the FM broadcast band by pressing the FM pushbutton on the front panel or on the Remote Control.
3. Press a front panel TUNING Up or Down push-button, or a SEEK pushbutton on the Remote Control, to select stations. Press and release the pushbutton to move from one station to the next. Press and hold to move continuously up or down the broadcast band. When a station is selected, the front panel display will indicate (from left to right) station signal strength from 1 to 9, a dot if the station is broadcasting stereo, the FM station fre-

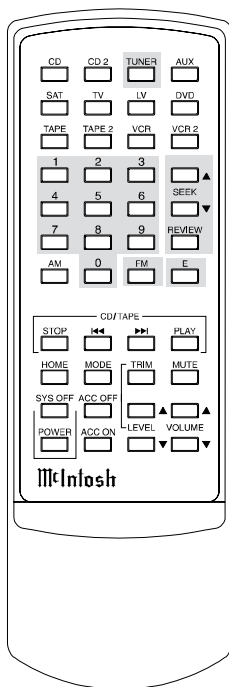

Figure 26

quency and a preset number if that station has been assigned a preset.

*Note: FM band indications are in Megahertz, in the US and Canada, and change frequency in 100kHz steps. The second digit to the right of the dot which displays a 0, is used for FM stations in various locations other than the US where stations change in 50Hz steps.*

### How to Assign FM Presets

1. To assign an FM preset, tune to the desired FM station with a TUNING Up or Down pushbutton or a SEEK Up or Down pushbutton on the Remote Control.

*Note: If no FM presets have been assigned, when a PRESET Up or Down pushbutton is pressed, the front panel display will indicate NO PRESETS. Refer to figure 27.*

2. Momentarily press and release the front panel ENTER pushbutton. The ENTER pushbutton LED will turn on and the front panel display will indicate 1 AVAILABLE, which is the first of 9 preset numbers that can be assigned. Refer to figure 28.

*Note: Presets are automatically assigned in order from 1 to 9.*

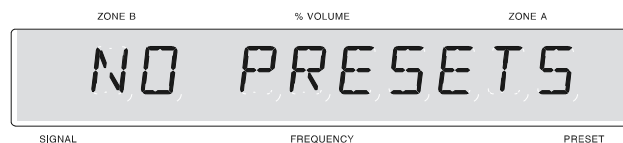

Figure 27

3. Press and release the front panel ENTER pushbutton a second time to activate the assignment memory. The ENTER pushbutton LED will turn off and the FM station preset selection will be assigned preset number 1, and stored in memory. The assigned preset number will appear to the right of the station frequency whenever that station is selected.

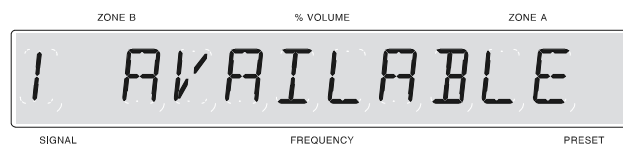

Figure 28

4. Assign additional station Presets by performing steps 1 through 3 until a total of 9 FM presets have been assigned. Each time you assign an additional preset number, the display will indicate the number of the next available preset. If all 9 presets are assigned and you press ENTER, the display will indicate the station selected for preset number 1.
5. Press a PRESET Up or Down pushbutton to cycle through and confirm your preset assignments.

**How To Clear an FM Preset Number**

1. Press and release the ENTER pushbutton.
2. Press a PRESET Up or Down pushbutton to select the desired station preset you wish to clear.
3. Press and Hold the ENTER pushbutton for approximately 5 seconds until the front panel display indicates the preset number and the word CLEARED appears on the front panel display. Refer to figure 29.

**How to Tune FM Stations with Tuner Presets**

1. Access the Presets directly by pressing the preset number pushbutton on the Remote Control.
2. Cycle through the presets by pressing a front panel PRESET Up or Down pushbutton.
3. Access the presets by pressing the Remote Control REVIEW pushbutton. This starts the automatic brief audition of each of the preset stations stored in the PRESET memory for FM. Only the presets stored in memory will be reviewed. If five presets have been stored in memory, only those five will be reviewed. Press REVIEW a second time, or press any other Tuner function pushbutton to stop on the desired preset station, and exit the REVIEW process.

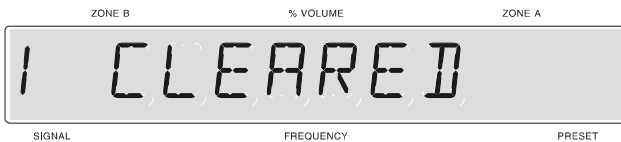

Figure 29

FM Station Presets				
Preset No.	Frequency	Call Letters	City	Remarks
1				
2				
3				
4				
5				
6				
7				
8				
9				

### How to Operate the AM Tuner

The McIntosh MX132 incorporates an advanced design AM tuner with many desirable performance features to enhance your enjoyment of radio broadcasts. There are four methods of tuning to an AM broadcast station. These are Manual, Automatic Preset Review, Preset pushbutton search and Direct Preset number access with the Remote Control.

### How to tune AM stations Manually

1. Select TUNER with the front panel INPUT A switch or the Remote Control TUNER pushbutton. Refer to Figure 30 & 31.

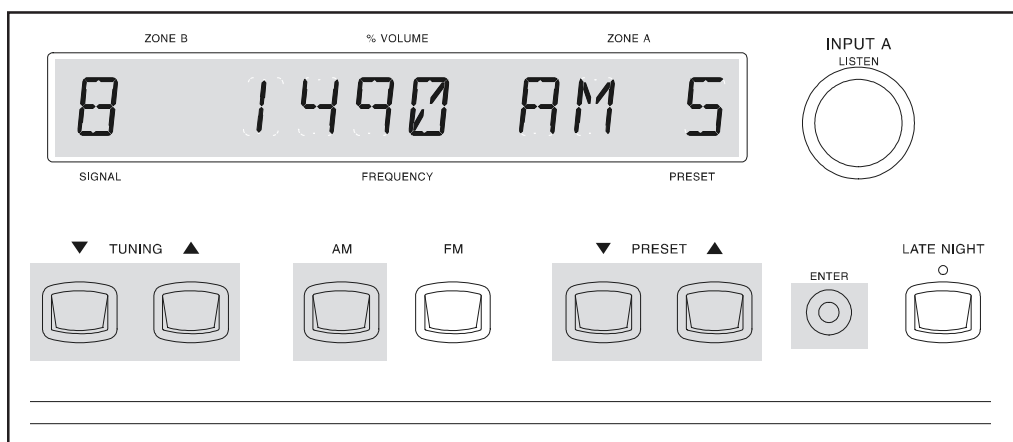

Figure 30

2. Select the AM broadcast band by pressing the AM pushbutton on the front panel or on the Remote Control.
3. Press a front panel TUNING Up or Down push-button, or a SEEK pushbutton on the Remote Control, to select stations. Press and release the pushbutton to move from one station to the next. Press and hold to move continuously up or down the broadcast band. When a station is selected, the front panel display will indicate (from left to right) station signal strength from 1 to 9, the AM station frequency and a preset number if that station has been assigned a preset.

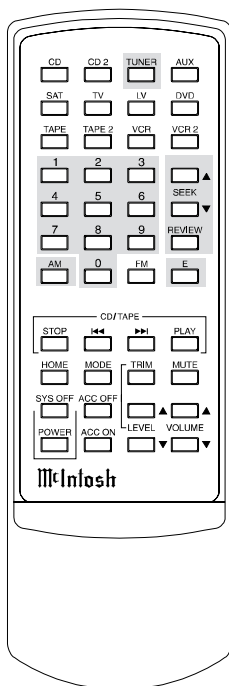

Figure 31

*Note: AM band indications are in Kilohertz and change frequency in 10kHz steps.*

### How to Assign AM Presets

1. To assign an AM preset, tune to the desired AM station with a TUNING Up or Down pushbutton or a SEEK Up or Down pushbutton on the Remote Control.

*Note: If no AM presets have been assigned, when a PRESET UP or Down pushbutton is pressed, the front panel display will indicate NO PRESETS. Refer to figure 32.*

2. Momentarily press and release the front panel ENTER pushbutton. The ENTER pushbutton LED will turn on and the front panel display will indicate 1 AVAIL-

ABLE, which is the first of 9 preset numbers that can be assigned. Refer to figure 33.

*Note: Presets are automatically assigned in order from 1 to 9 on AM.*

3. Press and release the front panel ENTER pushbutton a second time to activate the assignment memory. The ENTER pushbutton LED will turn off and the AM station preset selection will be assigned preset number 1, and stored in memory. The assigned preset number will appear to the right of the station frequency whenever that station is selected.

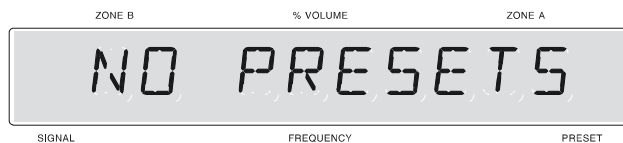

Figure 32

4. Assign additional station Presets by performing steps 1 through 3 until a total of 9 AM presets have been assigned. Each time you assign an additional preset number, the display will indicate the number of the next available preset. If all 9 presets are assigned and you press ENTER, the display will indicate the station selected for preset number 1.



Figure 33

5. Press a PRESET Up or Down pushbutton to cycle through and confirm your preset assignments.

**How to Clear an AM Preset Number**

1. Press and release the ENTER pushbutton.
2. Press a PRESET Up or Down pushbutton to select the desired station preset you wish to clear.
3. Press and Hold the ENTER pushbutton for approximately 5 seconds until the front panel display indicates the preset number and the word CLEARED appears on the front panel display. Refer to 34.

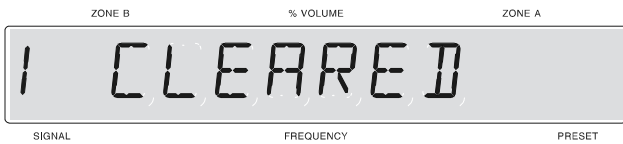

Figure 34

**How to Tune AM Stations with AM Tuner Presets**

1. Access the Presets directly by pressing the preset number pushbutton on the Remote Control.
2. Cycle through the presets by pressing a front panel PRESET Up or Down pushbutton.
3. Access the presets by pressing the Remote Control REVIEW pushbutton. This starts the automatic brief audition of each of the preset stations stored in the PRESET memory for AM. Only the presets stored in memory will be reviewed. If five presets have been stored in memory, only those five will be reviewed. Press REVIEW a second time, press any other Tuner function pushbutton to stop on the desired preset station, and exit the REVIEW process.

AM Station Presets				
Preset No.	Frequency	Call Letters	City	Remarks
1				
2				
3				
4				
5				
6				
7				
8				
9				

### How to Operate the Trim Mode

The MX132 Trim feature provides a means for adjusting seven different audio functions and the front panel display brightness either from the front panel controls or with the Remote Control. Level, Bass, Treble and Loudness Trim adjustments can be performed most conveniently in the Listening/Viewing area with the Remote Control. You can also perform the adjustments with the front panel controls if desired. You can create the sound quality that you prefer while listening to music or a sound track. Refer to figures 35 & 36.

*Note: The following Trim Instructions refer only to trim setting examples, make any Trim adjustments based on your own preferences.*

### Loudspeaker Level

The levels of the Center, Subwoofer and Surround loudspeakers can be trimmed up or down by 12dB. Trim levels can be adjusted separately for Surround modes of STEREO, MUSIC 1,2 and 3, EXTERNAL and MONO and saved in permanent memory. Any Surround Trim level adjustments made in CINEMA and THX CINEMA will revert back to the Setup levels when the MX132 is turned off.

1. Press and release the TRIM pushbutton on the Remote Control until SUB TRIM appears on the front panel display. Refer to figure 37.

*Notes: 1. You can also perform all TRIM functions with the front panel TRIM SELECT and TRIM LEVEL controls.*

2. Low frequency information must be present in the program source material in order to hear any changes in the subwoofer loudspeaker levels.

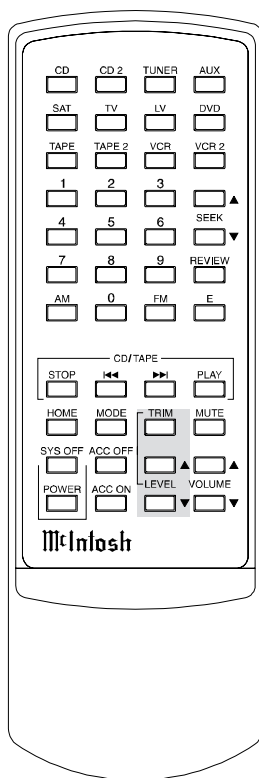

Figure 36

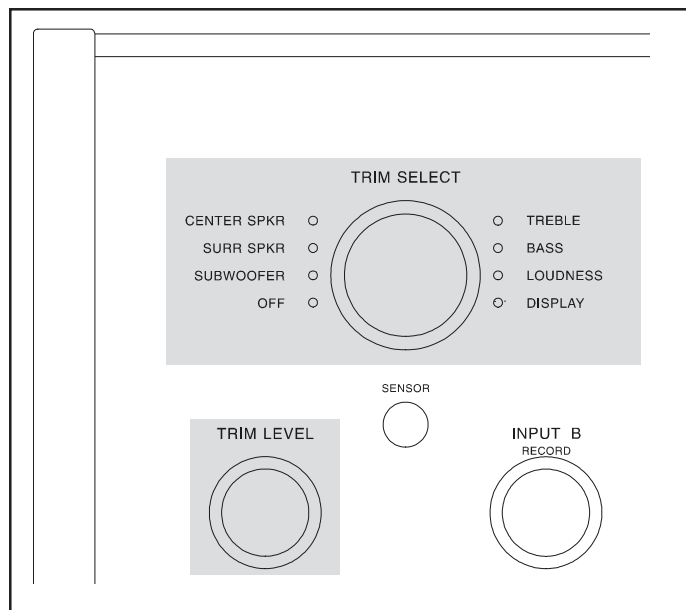

Figure 35

2. Press the LEVEL Up pushbutton until the number 5 appears to the right of SUB TRIM on the front panel display. This is an example of increasing the Subwoofer level by 5dB.
3. Press and release the TRIM pushbutton until SURR TRIM appears on the front panel display. Refer to figure 38.

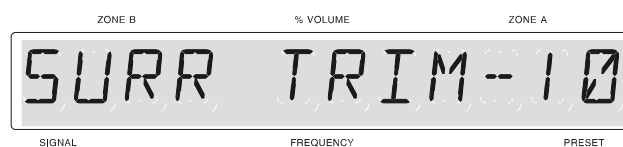

Figure 38

4. Press the LEVEL Down pushbutton until the number 10 appears to the right of SURR TRIM on the front panel display. This is an example of decreasing the Surround loudspeaker levels by 10dB.
5. Press and release the TRIM pushbutton until CTR TRIM appears on the front panel display. Refer to figure 39.

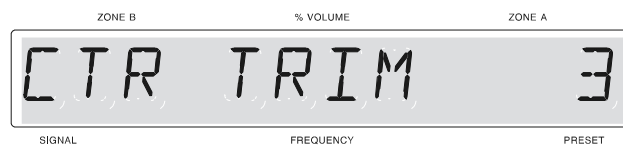

Figure 39

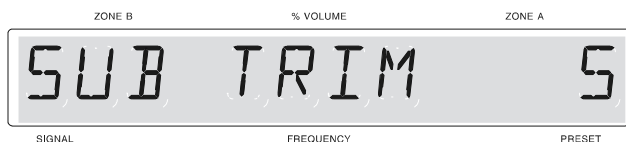

Figure 37



- Press and release LEVEL Up pushbutton until the number 3 appears to the right of CTR TRIM on the front panel display. This is an example of increasing the Center loudspeaker level by 3dB.

*Note: 1. If no Trim adjustments are changed for ten seconds, the TRIM mode will be canceled and the normal front panel display will appear. To exit quickly from the TRIM mode, press and release the TRIM pushbutton until TRIM OFF appears on the display. After five seconds, the front panel display will return to normal.*

- The location of the Trim Selector Control will remain in the last selected position until the INPUT A Signal Source or surround mode is changed.

### Bass and Treble

Bass and Treble response can be trimmed up or down by 12db. Tone control Trim levels can be adjusted separately for each of the eleven inputs and will be saved in permanent memory for all SURROUND MODES except for THX CINEMA. Any Bass, Treble or Loudness Trim adjustments performed on an input being used in THX CINEMA mode will revert back to the 0 or flat settings when the MX132 is turned off.

- Press and release the TRIM pushbutton until BASS TRIM appears on the front panel Display. Refer to figure 40.

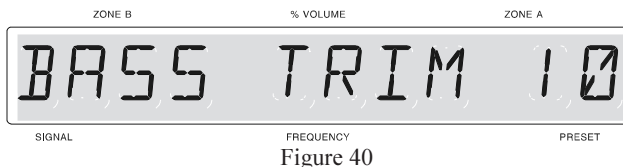

- Press and release the LEVEL Up pushbutton until the number 10 appears to the right of BASS TRIM on the front panel display. This is an example of increasing the Bass response by 10dB.
- Press and release the TRIM pushbutton until TREB TRIM appears on the front panel display. Refer to figure 41.

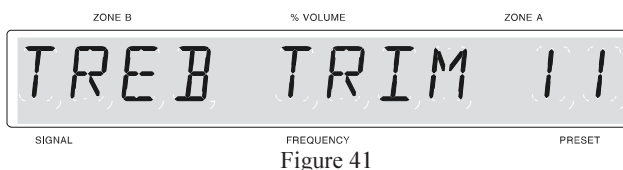

- Press and release the LEVEL Up pushbutton until the number 11 appears to the right of TREB on the front panel display. This is an example of increasing the Treble response by 11dB.

### Loudness Compensation

The MX132 Loudness control function automatically increases bass response as the volume level is lowered for improved listening at softer volume levels. The amount of Loudness boost is adjustable in 10% increments from 10% to 100% of the available boost. The maximum available Loudness boost is 18dB, less any bass boost that may have been previously set by the Bass Trim function. For example if the Bass is boosted 10dB, the maximum additional Loudness boost will be 18dB less 10dB or 8dB. Any Loudness Trim adjustments performed on an input being used in THX CINEMA mode will revert back to 0 or the flat setting when the MX132 is turned off.

- Press the TRIM pushbutton until TRIMLOUD appears on the front panel display. Refer to figure 42.

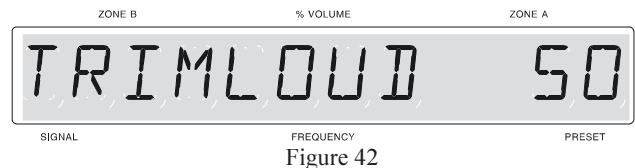

- Press a LEVEL Up or Down pushbutton until the desired percent of Loudness is indicated to the right of TRIMLOUD on the front panel display.

### Display Brightness

The MX132 Trim feature allows you to adjust the brightness of the Front Panel Display to the desired intensity. The Display Trim brightness range extends from off to a maximum of 31.

*Note: You may find it easiest to make Display adjustments with the front panel controls.*

- Press and release the TRIM pushbutton, or turn the TRIM SELECT Control, until DISPLAY appears on the front panel display. A number to the right of the display indicates the current brightness level. Refer to figure 43.

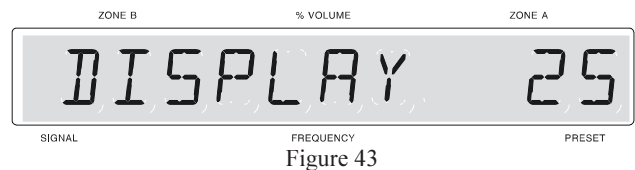

- Press a LEVEL Up or Down pushbutton, or turn the TRIM LEVEL Control, until you reach the desired display brightness.

### How to Operate the Surround Mode

The MX132 provides eight different Surround audio operating modes. The front panel Display and the Output Format LED's will indicate the mode you have selected. The mode you select for any input will automatically be memorized and will switch to that mode every time the same input is again selected. If the surround mode is changed when the input is again selected, the new mode will be active. When an analog input is selected in Stereo or Mono Modes, the front panel display will indicate PURE STEREO or PURE MONO. When a digital input is selected in Stereo or Mono Modes, the Front panel will read DSP (Digital Signal Processing) STEREO or DSP MONO. All other surround modes are indicated in the display as they appear on the front panel SURROUND MODE selector nomenclature. Refer to Figure 44.

*Note: The Remote Control may also be used to make changes to the Surround Modes. Refer to figure 45.*

### Stereo Mode

A Stereo signal source connected to an Analog audio input is reproduced without any processing. The front panel Display will indicate PURE STEREO. When a Digital Audio input is selected in stereo mode, the front panel Display will indicate DSP STEREO. All multi-channel signal sources are combined and reduced to 2 channels in the stereo mode. The Output Format LEDs L, R and SUB will light. Refer to Figures 46, 47 and 48.

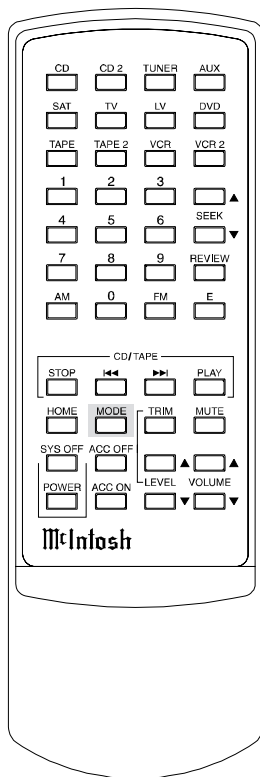

Figure 45

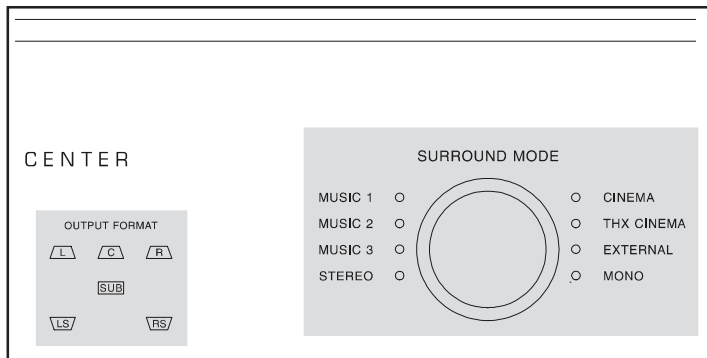

Figure 44

*Note: If the Subwoofer was turned OFF in the SPEAKER SIZE setup, the OUTPUT FORMAT SUB LED will not light.*

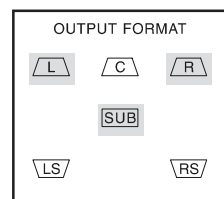

Figure 48

### Music 1, 2 and 3 Surround Modes

Digital Signal Processing is applied to all six channels in three different Music Mode variations to enhance two channel stereo signals.

### Music 3

The ambience present in stereo recorded music is reinforced by this processing. The Left and Right Difference Signal is sent to the Left and Right Surround loudspeakers. The Left and Right Stereo signals are combined and sent to the Center loudspeaker. The front panel Display will indicate MUSIC 3. The Output Format LED's L, C, R, LS, RS and SUB will light. Refer to Figures 49 and 51.

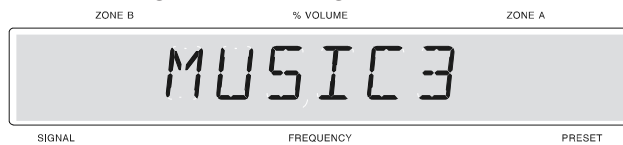

Figure 49

### Music 2

This processing mode creates an effect similar to listening in a smaller room and will enhance pop and rock music. Left and Right Stereo signals are combined and sent to the Left and Right Surround loudspeakers with a fast decay time. The combined Left and Right signals are also combined and sent to the center loudspeaker. The front panel Display will indicate MUSIC 2. The Output Format LED's L, C, R, LS, RS and SUB will light. Refer to Figures 50 and 51.

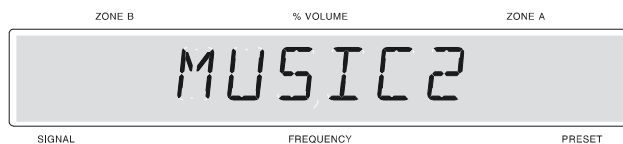

Figure 50

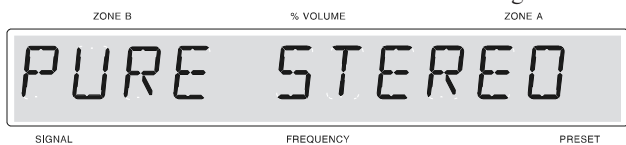

Figure 46



Figure 47

**Music 1**

This processing mode creates an effect similar to listening in a large room or an outdoor area. The Left and Right Stereo signals are combined and sent to the Left and Right Surround loudspeakers with a long time delay. The combined Left and Right signals are also sent to the Center loudspeaker. The front panel Display will indicate MUSIC 1. The Output Format LED's L, C, R, LS, RS and SUB will light. Refer to Figures 52 and 51.

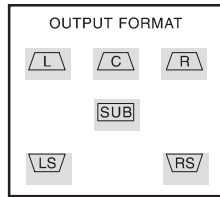

Figure 51

*Note: If DTS FULL RANGE MODE ON is selected in the SPEAKER SIZE MENU, and any MUSIC mode is selected, then all speakers are automatically reconfigured for LARGE. This mode is switched on whenever a DTS encoded music signal is detected. DTS movie sound tracks from a DVD or Laser Disc player should be reproduced in CINEMA or THX CINEMA mode in order to restore the required LFE channel bass boost.*

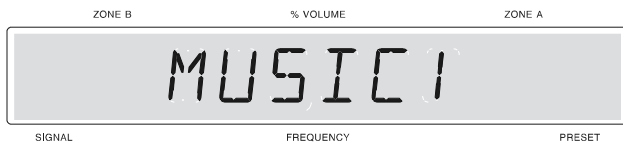

Figure 52

**Cinema**

This provides decoding of Dolby Pro Logic 2 channel Analog or Digital signals and decoding of Dolby Digital signals or DTS signals. The front panel Display will indicate CINEMA. The Output Format LED's L, C, R, LS, RS and SUB will light. Refer to Figures 53 and 51.

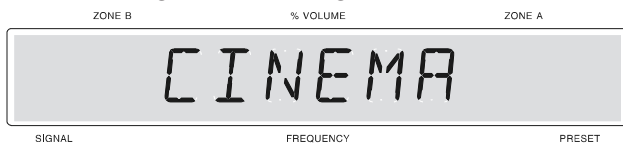

Figure 53

**THX Cinema**

THX signal processing is active in this mode, and is best for reproducing a film sound track that was originally created for use in a movie theater. THX Adaptive Decorrallation, Re-EQ Filtering and Timbre Match are added to the Pro Logic, Dolby Digital and DTS decoded signals. The front panel display will indicate THX CINEMA. The Output Format LED's L, C, R, LS, RS and SUB will light. Refer to Figures 54 and 51.

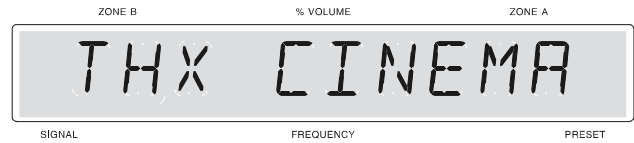

Figure 54

**External**

All internal signal processing is bypassed and the six Rear Panel EXTERNAL INPUTS are activated so the MX132 performs as a six channel preamplifier for an external processor. The front panel display indicates EXTERNAL and the OUTPUT FORMAT LED's L, C, R, LS, RS, and SUB will light. Refer to Figures 55 and 51.

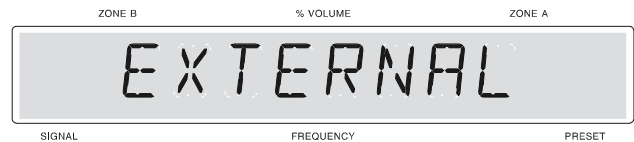

Figure 55

**Mono**

All Mono Analog signals are reproduced without any processing and are sent only to the CENTER loudspeaker. When an Analog input is selected, the front panel display will indicate PURE MONO. When a Digital input is selected, the front panel Display will indicate DSP MONO. All Multi channel signal sources are combined to a single channel for mono. The OUTPUT FORMAT LED's C and SUB will light. Refer to Figures 56, 57 and 58.

*Note: If the Subwoofer was turned OFF in the SPEAKER SIZE setup, the OUTPUT FORMAT SUB LED will not light.*

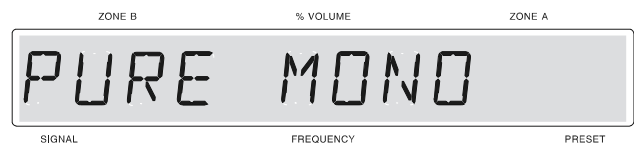

Figure 56

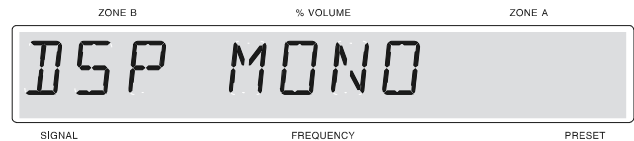

Figure 57

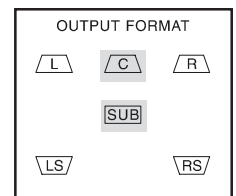

Figure 58

### How to Operate Zone B

The MX132 includes the valuable feature of being able to operate and control two audio/video zones, independently of each other. Zone A is designed to be the primary or Home Theater listening area with a full featured surround sound and signal processing capability.

Zone B is configured for a remote location to provide two channel audio and video programs which can conveniently access all the audio/video source components connected for Zone A. You can enjoy one program source in Zone A, and another different program source and volume level in Zone B.

The program source selected for Zone A appears at the right on the MX132 Front Panel Display, and the program source selected for Zone B appears to the left. Zone A source selections are also referred to as Input A/ Listen signals and are selected by the Input A/Listen selector. Zone B source selections are also referred to as Input B/Record signals and are selected by the Input B/Record selector.

1. Turn ON Zone B by pressing the POWER pushbutton on a keypad, or Remote Control in Zone B. Refer to Figure 59 & 60.

*Note: The only way Zone B can be turned on, is from a keypad or a Remote Control located in Zone B. If Zone B is on and Zone A is not on, the MX132 Front Panel Display will indicate ZONE B ON. Source selection may also be accomplished from the front panel INPUT B (Record) selector after Zone B has been turned on.*

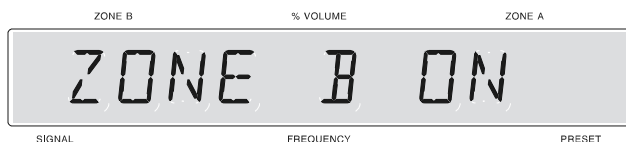

Figure 60

2. Select the desired Listening source by pressing an INPUT pushbutton on a keypad or Remote Control. Refer to Figure 61 & 62.

*Note: The wakeup preset volume level can be adjusted to the desired level by accessing the ZONE B VOLUME PRESET LEVEL MENU.*

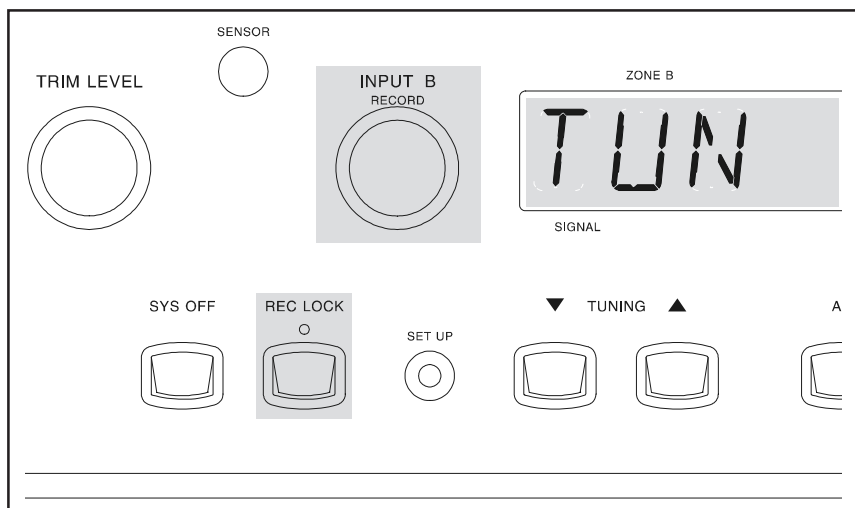

Figure 59

3. Adjust the Volume to the desired listening level by pressing an UP or DOWN pushbutton on a keypad or Remote Control. Refer to the Keypad Owner's Manual for detailed operating instructions.
4. Mute the audio by pressing the MUTE pushbutton on a keypad or Remote Control.
5. If a McIntosh CD Player is connected to the MX132, most major operating functions can be performed with a keypad or Remote Control.
6. Turn Zone B OFF by pressing the Remote Control POWER pushbutton.
7. Turn the entire MX132 System OFF from Zone B by pressing the SYS OFF pushbutton on a keypad or remote Control.

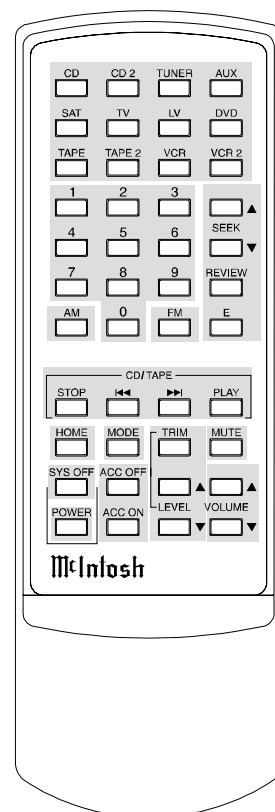

Figure 61

#### Rec Lock

Press the MX132 front panel REC (Record) LOCK pushbutton to block all Zone B operating functions. Since Zone B program sources are also Record signals, this al-

allows a record process to be performed in Zone A without interference. Refer to figure 59.

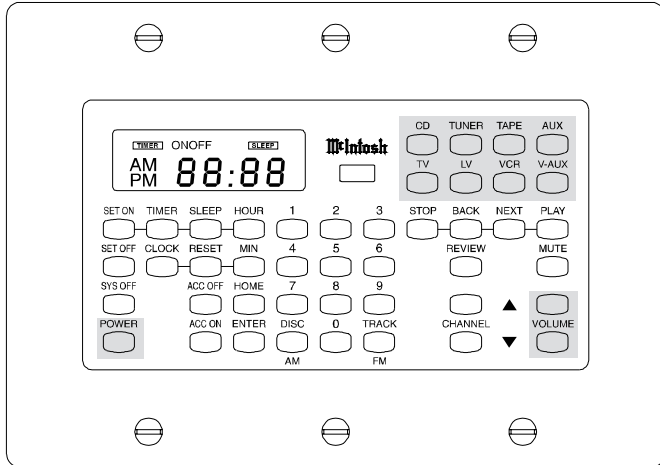

Figure 62

**Zone B Tone Controls**

The MX132 includes rear panel Bass and Treble controls that are dedicated to Zone B and can be adjusted for the desired sound characteristics. Bass and Treble can be increased or decreased by 12dB. Zone A Bass and Treble Trim settings do not affect Zone B. Refer to figure 63.

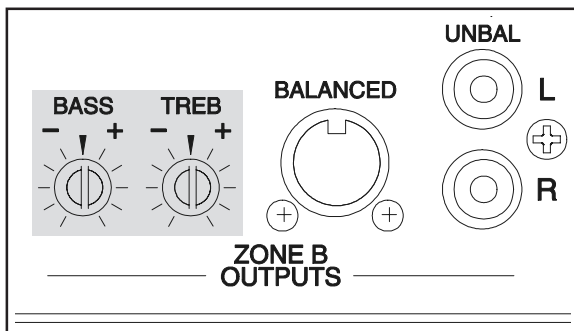

Figure 63

**How to Operate Additional Zones**

When the MX132 is connected with a CR12, the MX132 provides fixed specific audio signals that match the CR12 inputs. For example, if the MX132 TV input (7), is re-assigned as DVD2, selecting the TV input on the CR12 will receive the audio signals from DVD2 connected to the MX132 input Number 7.

<u>MX132 Inputs</u>	<u>CR12 Matching Inputs</u>
0. (TUNER)	TUNER
1. (AUX)	AUX
3. (CD2)	CD2
4. (TAPE 1)	TAPE 1
7. (TV)	TV
8. (LV)	LV
9. (VCR1)	VCR1
11. (DVD)	VAUX (DVD)

The MX132 can be connected to one or more CR12 Multizone Controllers, to add up to 16 additional remote Audio/Video zones. If the CR12 is active in one or more remote zones and neither MX132 Zone A or Zone B is active, the MX132 Front Panel Display will indicate REMOTE ZONE. Refer to figure 64.

*Note: If the MX132 Zone A is also turned on, the normal Zone A displays will be present. If only Remote Zone B is turned on in addition to the CR12 zones, the Front Panel Display will change to indicate ZONE B ON.*

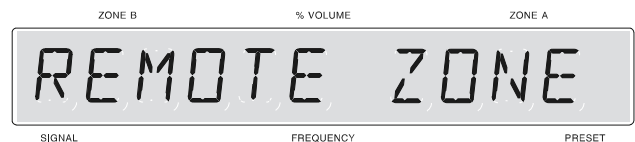
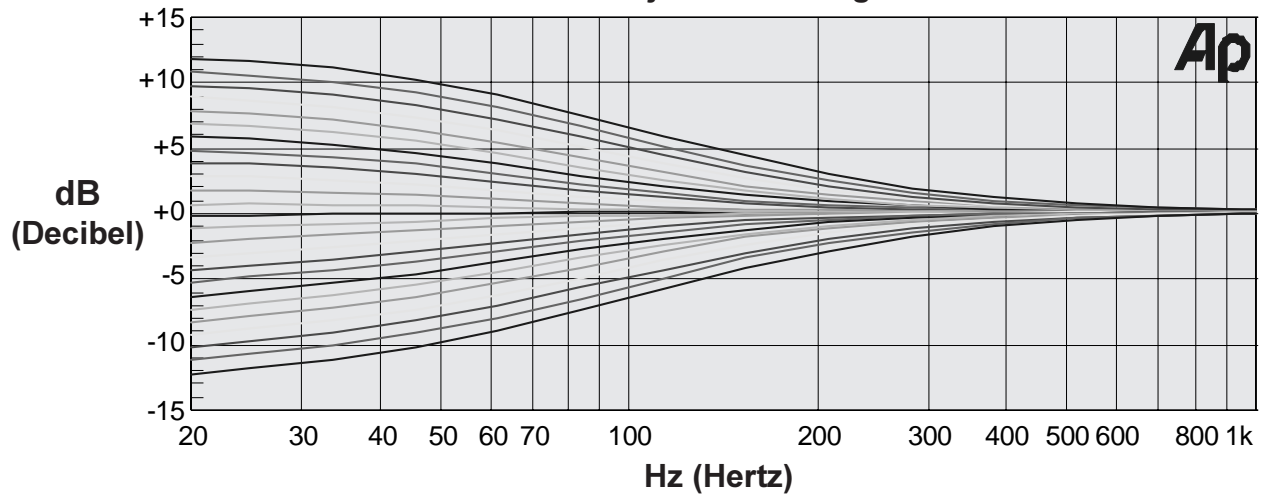
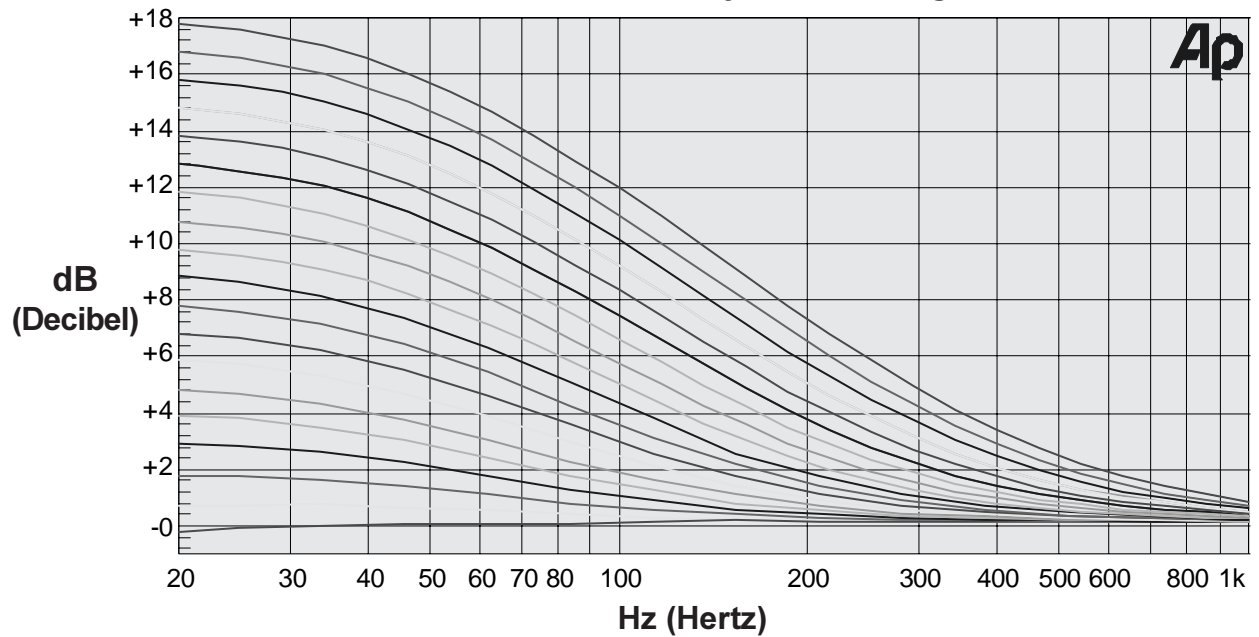

Figure 64

### Bass Control Adjustment Range



### Loudness Control Adjustment Range





Treble Control Adjustment Range

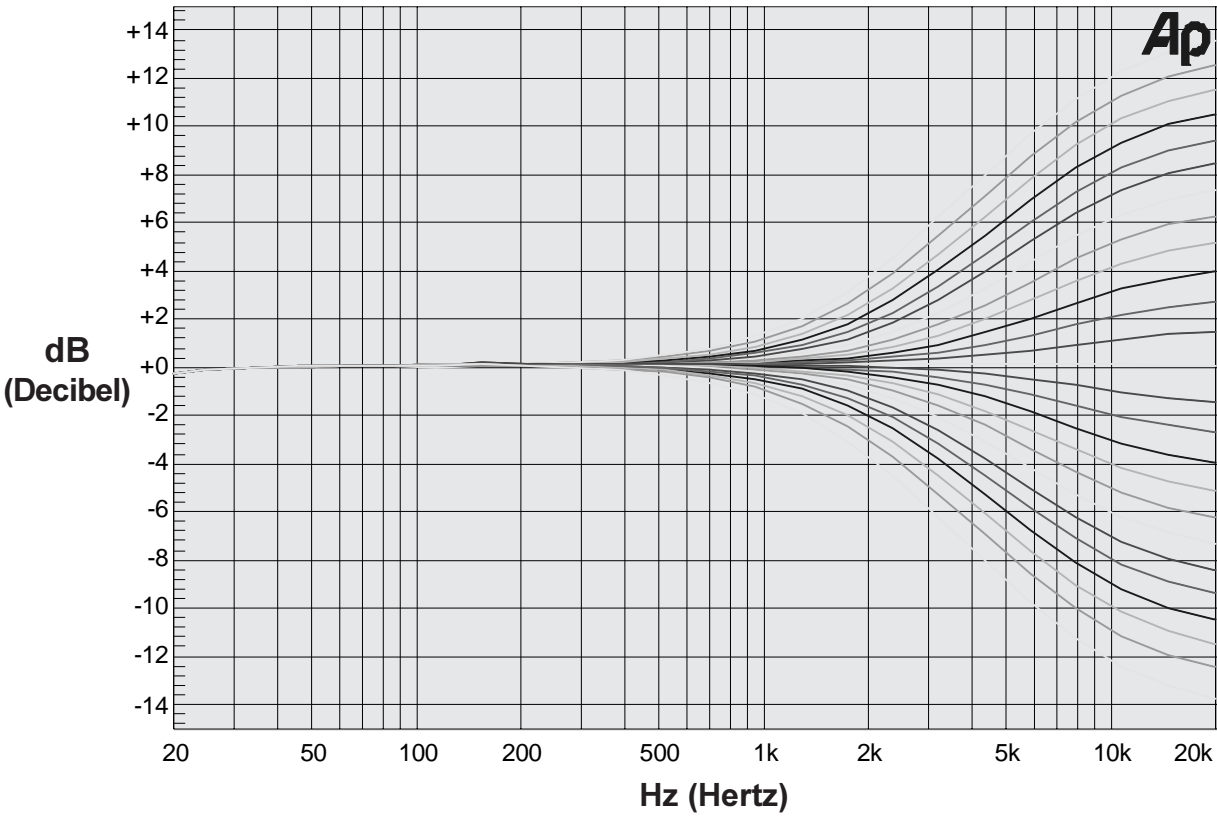

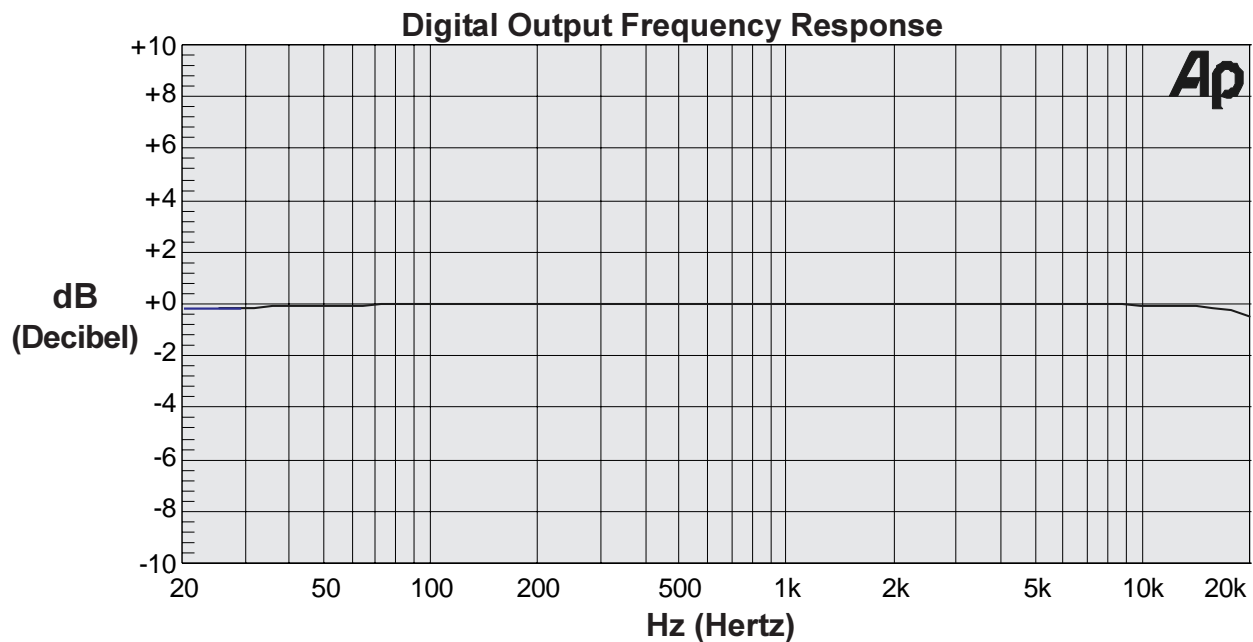
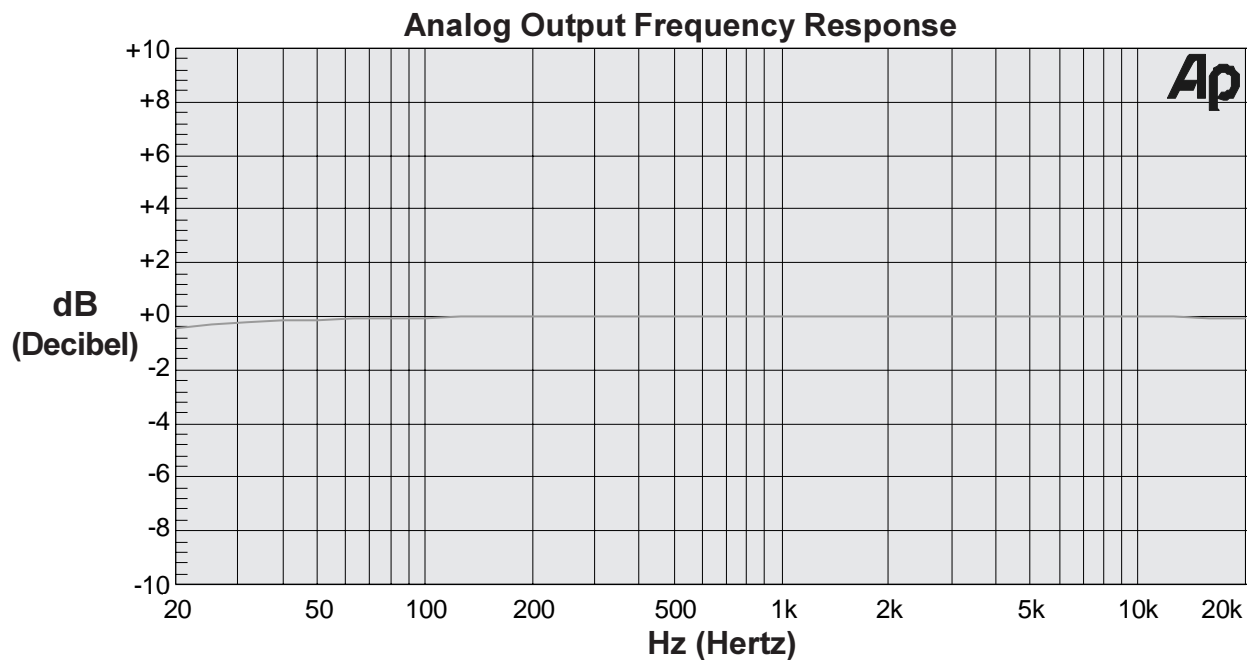

**FM Tuner Specifications**

**Useable Sensitivity**

14dBm which is 1.4uV across 75 ohms

**50dB Quieting Sensitivity**

Mono: 19dBm which is 2.4uV across 75 ohms

Stereo: 35dBm which is 15uV across 75 ohms

**Signal To Noise Ratio**

Mono: 75dB

Stereo: 70dB

**Frequency Response**

Mono: + 0, - 1dB from 20 to 15,000Hz

Stereo: + 0, - 1dB from 20 to 15,000Hz

**Harmonic Distortion**

Mono: 0.3% at 100Hz

0.3% at 1000Hz

0.3% at 10,000Hz

Stereo: 0.45% at 100Hz

0.45% at 1000Hz

0.65% at 10,000Hz

**Intermodulation Distortion**

Mono 0.25%

Stereo 0.45%

**Capture Ratio**

1.2dB

**Alternate Channel Selectivity**

75dB

**Spurious Response**

100dB

**Image Response**

75dB

**RF Intermodulation**

65dB

**Stereo Separation**

45dB at 100Hz

45dB at 1000Hz

35dB at 10,000Hz

**SCA Rejection**

65dB

**AM Tuner Specifications**

**Sensitivity**

20uV External Antenna Input

**Signal To Noise Ratio**

48dB at 30% modulation

58dB at 100% modulation

**Harmonic Distortion**

0.5% maximum at 50% modulation

**Frequency Response**

50Hz to 6kHz NRSC

**Adjacent Channel Selectivity**

45dB minimum IHF

**Image Rejection**

65dB minimum from 540 to 1600kHz

**IF Rejection**

80dB minimum

**Audio Specifications**

**Frequency Response**

STEREO Left and Right Small speakers:

80Hz-20,000Hz

Subwoofer:

20Hz-80Hz

Left and Right Large speakers:

20Hz-20,000Hz

Subwoofer:

OFF

PRO LOGIC Left, Center, Right, Small speakers:

80Hz-20,000Hz

Surround Small speakers:

80Hz-7kHz

Subwoofer:

20Hz-80Hz

Left, Center, Right, Large speakers:

20Hz-20,000Hz

Surround Large speakers:

20Hz-7kHz

Subwoofer:

OFF

### Audio Specifications, con't

Dolby Digital and DTS Left, Center, Right Small speakers:  
80Hz-20,000Hz  
Surround Small speakers:  
80Hz-20,000Hz  
Subwoofer:  
20Hz-80Hz

Left, Center, Right Large speakers:  
20Hz-20,000Hz  
Surround Large speakers:  
20Hz-20,000Hz  
Subwoofer:  
20Hz-80Hz

External Input Left, Center, Right, Left Surround,  
Right Surround:  
20Hz-20,000Hz  
Subwoofer:  
20Hz-120Hz

#### Rated Output

All Modes: 2.0VRMS for full bit digital input

#### Input Impedance

22K ohms

#### Output Impedance

47 ohms at all outputs

#### Maximum Output Voltage

9.5 VRMS

#### Total Harmonic Distortion

0.005% at all outputs

#### Sensitivity

Analog Input: 400mV for 2.0V output

#### Signal To Noise Ratio - All Outputs

Greater than 90dB un-weighted  
Greater than 100dB A weighted  
Greater than 98dB CCIR

#### Maximum Input Signal

Analog Input: 6Vrms

#### Voltage Gain

Analog Input to Output: 14dB

#### Frequency Response

+0, -0.5dB from 20Hz to 20,000Hz

#### Tone Controls

+12dB, -12dB from flat setting

### General Specifications

#### Power Requirements

100 Volts, 50/60Hz at 65 watts  
110 Volts, 50/60Hz at 65 watts  
120 Volts, 50/60Hz at 65 watts  
220 Volts, 50/60Hz at 65 watts  
230 Volts, 50/60Hz at 65 watts  
240 Volts, 50/60Hz at 65 watts

*NOTE: Refer to the rear panel of the MX132 for the correct voltage.*

#### Dimensions

Front Panel: 17 1/2 inches (44.5cm) wide, 7-1/16 inches (17.9cm) high. Depth behind front mounting panel is 21 inches (53.3cm) including clearance for connectors. Panel clearance required in front of mounting panel is 1-1/8 inches (2.9cm).

#### Weight

32.5 pounds (14.8Kg) net, 53.5 pounds (24.5Kg) shipping

## Packing Instructions

In the event it is necessary to repack the equipment for shipment, the equipment must be packed exactly as shown below. It is very important that the four plastic feet are attached to the bottom of the equipment. This will ensure the proper equipment location on the bottom pad. Failure to do this will result in shipping damage.

Use the original shipping carton and interior parts only if they are all in good serviceable condition. If a shipping carton or any of the interior part(s) are needed, please call or write Customer Service Department of McIntosh Laboratory. Please see the Part List for the correct part numbers.

Quantity	Part Number	Description
1	034040	Shipping carton only
2	033887	End cap (with cut out for corrugated wrap)
2	034039	End cap
1	033697	Inside carton only
1	033725	Top pad
1	034008	Bottom pad
1	034037	Inner carton pad
1	034044	Corrugated wrap
4	017218	Plastic foot
4	100159	#10-32 x 3/4" screw
4	104083	#10-7/16" Flat washer
1	049267	Shipping carton complete with all the above parts

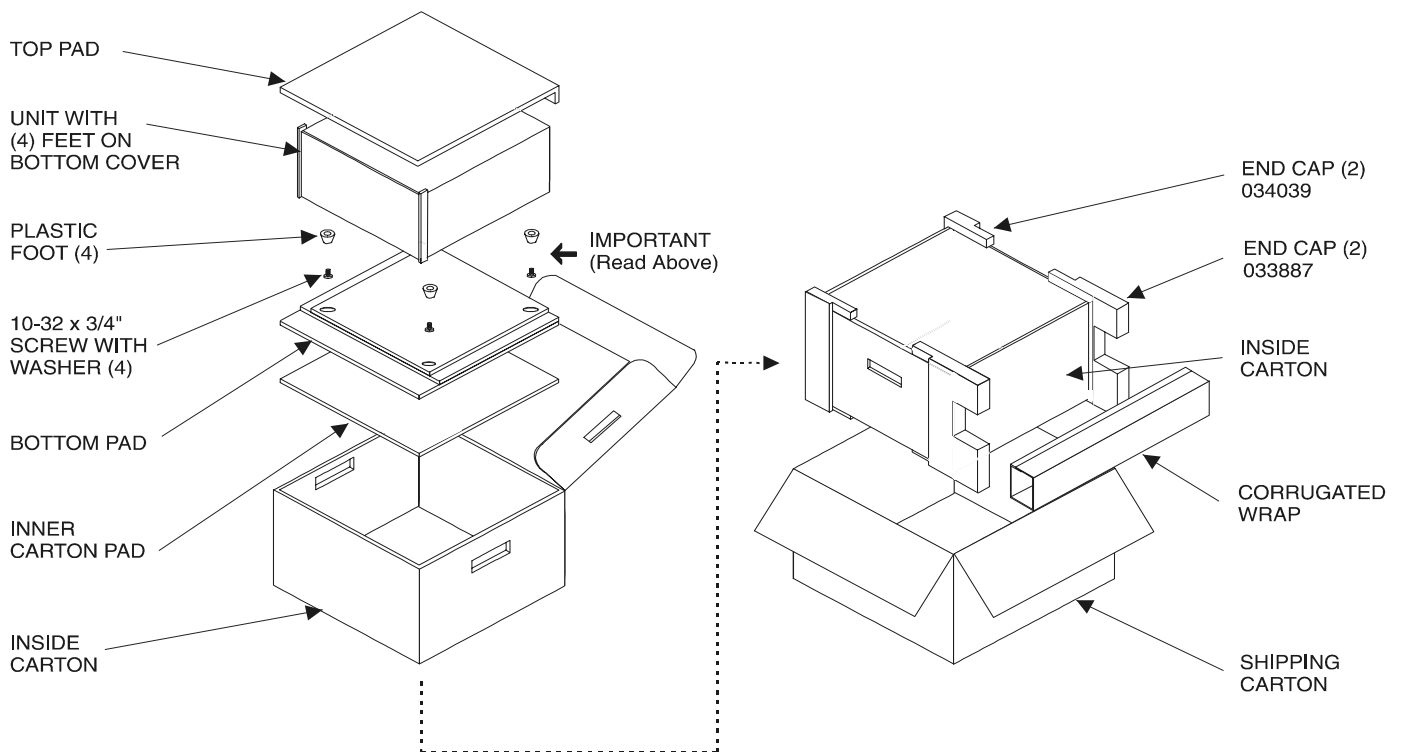

**McIntosh<sup>®</sup>**

McIntosh Laboratory, Inc.  
2 Chambers Street  
Binghamton, NY 13903