

McIntosh
MR 80

OWNER'S MANUAL

THE McINTOSH MR 80 DIGITAL FM TUNER



Reading Time: 32 Minutes

Price: \$2.00

VARIOUS REGULATORY AGENCIES REQUIRE THAT WE BRING THE FOLLOWING INFORMATION TO YOUR ATTENTION. PLEASE READ IT CAREFULLY.

WARNING: TO PREVENT FIRE OR SHOCK HAZARD, DO NOT EXPOSE THIS UNIT TO RAIN OR MOISTURE.

The McIntosh you have purchased is a Model MR 80. It has a serial number located on the rear panel of the chassis. Record that serial number here:

Serial Number

The model, serial number and purchase date are important to you for any future service. Record the purchase date here:

Purchase date

Upon application, McIntosh Laboratory provides a Three-Year Service Contract. Your McIntosh authorized service agency can expedite repairs when you provide the Service Contract with the instrument for repair. To assist, record your Service Contract number here:

Service Contract Number

Your MR 80 Digital FM Tuner can give you many years of satisfactory performance. If you have any questions, please contact:

CUSTOMER SERVICE

McIntosh Laboratory Inc.
2 Chambers Street
Binghamton, New York 13903-9990
Phone: 607-723-3512

**Take Advantage of 3 years
of Contract Service ...
Fill in the Application NOW.**

Contents

SERVICE CONTRACT INFORMATION ...	1
INSTALLATION ..	2
HOW TO CONNECT AND BACK PANEL INFORMATION...	4
FRONT PANEL INFORMATION AND USE OF CONTROLS. . .	6
TOP PANEL INFORMATION AND SECONDARY CONTROLS ...	8
PERFORMANCE LIMITS . . .	9
PERFORMANCE CHARTS. -	10
TECHNICAL DESCRIPTION. 14	
BLOCK DIAGRAM..	20

McINTOSH THREE YEAR SERVICE CONTRACT

An application for A THREE YEAR SERVICE CONTRACT is included with this manual.

The terms of the contract are:

1. McIntosh will provide all parts, materials and labor needed to return the measured performance of the instrument to the original performance limits. The SERVICE CONTRACT does not cover any shipping costs to and from the authorized service agency or the factory.
2. Any McIntosh authorized service agency will repair McIntosh instruments at normal service rates. To receive service under the terms of the SERVICE CONTRACT, the SERVICE CONTRACT CERTIFICATE must be presented when the instrument is taken to the service agency.
3. Always have service done by a McIntosh authorized service agency. If the instrument is modified or damaged as a result of unauthorized repair, the SERVICE CONTRACT will be cancelled. Damage by improper use or mishandling is not covered by the SERVICE CONTRACT.
4. The SERVICE CONTRACT is issued to you as the original purchaser. To protect you from misrepresentation, this contract cannot be transferred to a second owner.
5. To receive the SERVICE CONTRACT, your purchase must be made from a McIntosh franchised dealer.
6. Your completely filled in application for the SERVICE CONTRACT must be post-marked within 30 days of the date of purchase of the instrument.
7. To receive the SERVICE CONTRACT, all information on the application must be filled in. The SERVICE CONTRACT will be issued when the completely filled in application is received by McIntosh Laboratory Incorporated in Binghamton, New York.
8. Units in operation outside the United States and Canada are not covered by the McIntosh Factory Service Contract, irrespective of the place of purchase. Nor are units acquired outside the U.S.A. and Canada, the purchasers of which should consult with their dealer to ascertain what, if any, service contract or warranty may be available locally.

How to Connect and Back Panel Information



Refer to page 5.

AUDIO OUTPUTS

Use the FIXED OUTPUT jacks on the rear panel to feed program to a stereo control preamplifier or other equipment which has its own volume control. The front panel VOLUME control does not affect the loudness of the tuner at the FIXED OUTPUT jacks. The output level is a nominal 1 volt for 100% FM modulation.

Use the VARIABLE OUTPUT jacks to connect to equipment such as a power amplifier or a tape recorder where control of the volume at the tuner is desired. The output at the VARIABLE OUTPUT jacks is a nominal 2.5 volts for 100% FM modulation. There is no difference in the signal quality at either pair of output jacks.

Both pairs of OUTPUT jacks may be used simultaneously. The output impedance at both outputs is very low so that long audio cables can be used without a loss of high frequencies due to cable capacity.

RF INPUTS—ANTENNA CONNECTIONS

Two of four different antenna systems can be used with your MR 80. 1) an outdoor FM antenna, 2) an all channel (UHF-VHF-FM) antenna, 3) a cable input from your local cable company, or 4) the indoor dipole supplied with the MR 80. A switch is provided on the top level set panel to select between two of the four systems mentioned.

An outdoor antenna is recommended for optimum performance in all areas. In fringe areas, best results will be obtained with a highly directional FM antenna used in connection with a rotator. Rotate the antenna until the best reception is obtained. Connect a 300 ohm outdoor antenna to the 300W ANTENNA (red) terminals. Connect a 75 ohm antenna and/or 75 ohm cable system to the coaxial antenna jack.

A flexible folded dipole antenna supplied with your MR 80 may be used in urban or in high signal strength areas. The flexibility of the thin flat wire assembly permits it to be placed under a rug, tacked behind the stereo or placed in any other convenient location. In some cases it may be necessary to position the antenna for best signal reception. This should be done before it is permanently located.

Avoid locating this antenna next to other wires or metal objects. This antenna may not prove effective in houses having metal siding or metal clad insulation.

The cable signal from a local cable company or a second FM antenna with 75 ohms impedance may be connected to the coaxial cable jack.

REMOTE SCAN

The REMOTE SCAN CONTROL SIGNAL jack is to be connected to the cable push button assembly supplied with the MR 80 for remote tuning. Plug the cable into the CONTROL SIGNAL jack. Pressing the push button at the end of the cable causes the MR 80 to scan to the next station. The mode of scan can be selected by the STATION'S slide switch. In the PRESET position every time the push button is depressed the MR 80 will scan to the next preset station. In the ALL position depressing the button will cause the MR 80 to scan to the next station.

If REMOTE tuning is not used, leave the jack free of any connection.

SCOPE

The vertical and horizontal scope jacks are provided to connect to a maximum performance indicator or an oscilloscope for indication of FM multipath and signal strength. Connect the vertical jack to the vertical input of the indicator and the horizontal jack to the horizontal input.

UNSWITCHED AC POWER OUTLET

This outlet may be used to power auxiliary equipment such as an antenna rotator or a maximum performance indicator. Power is available whenever the MR 80 is connected to a power source.

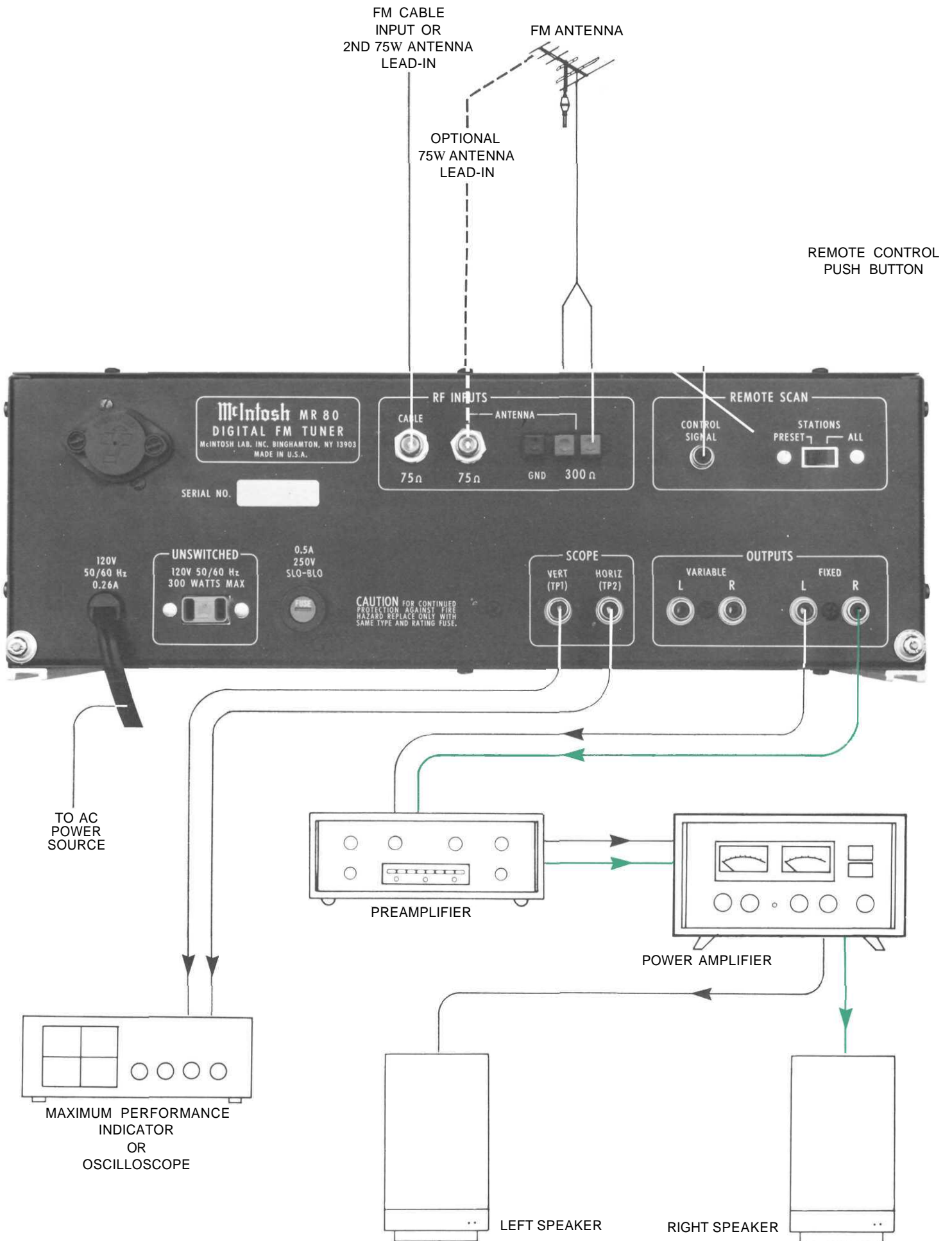

Front Panel Information and Use of Controls

The MR 80 Tuner has the most flexible control system ever designed in a stereo FM tuner. Correct use of these controls will yield a higher level of performance than previously possible with conventional tuners.

VOLUME CONTROL AND AC POWER SWITCH

The VOLUME control has been precision tracked throughout the listening range (0 to -65 dB) for accurate stereo balance.

It sets the output level of the VARIABLE OUTPUT jacks and the front panel HEADPHONE jack. The FIXED OUTPUT jacks are not affected by the position of the VOLUME control. The AC power switch is part of the VOLUME control. Turning the VOLUME control fully counterclockwise turns the AC power off.

TUNING CONTROLS AND FREQUENCY DISPLAY

Frequency Display

The Frequency Display indicates the received frequency to the nearest 100 kHz.

Tuning

There are four methods of tuning your MR 80. Automatic selection of the tuning method is provided by touch sensors associated with each of the tuning controls.

Manual Tuning

When power is applied to the MR 80, the circuitry automatically selects the manual or knob tuning control mode. Turning the tuning knob clockwise will increase the received frequency. Counterclockwise decreases the received frequency.

Note: When the MR 80 is operated but is not connected to any other device (preamp, power amp, antenna, test equipment, etc.), there is a chance the frequency display will blank out when tuning with the main tuning knob. This is normal and can easily be corrected by reversing the 120V AC line plug or by connecting the MR 80 to any other equipment.

Auto Scan

AUTO SCAN is provided by two touch pads immediately to the left of the tuning knob. These two touch pads start the tuner searching for a new station. The small arrow will light next to the pad touched and indicate the direction of scanning. It will scan in the direction chosen until it stops at a station or reaches the end of the band. At the band end the tuner will reverse its scan direction.

Preset 1, 2, 3 & 4

These touch pads located to the left of the frequency display select one of the four preset stations. Just touch to operate. A small rectangle will light above the pad indicating which preset has been selected.

Remote SCAN

Remote SCAN of either the presets or all stations is provided for as described under back panel information.

INDICATOR LIGHTS

Three indicator lights are provided immediately to the left of the preset touch pads. The uppermost STEREO indicates when a stereo broadcast is being received. The second, LOCK, indicates when the tuner is locked to the station. The lock circuit in the MR 80 is unique in that tuned frequency is locked to the station, not to an internal standard as in the case of many digital tuners. This allows the MR 80 to be tuned to any frequency within the FM band and lock on that frequency. Other digital tuners can only lock on specific channel assignments. This lock circuit is so powerful that it must be disabled in order to tune the tuner. You will notice that the moment that you touch any one of the tuning controls the lock light extinguishes and only comes on when the station is properly tuned. Once lock has been established it will remain on even if the station being received should drift up to 2 megacycles either side of the center of the carrier. Thus, perfect tuning is always assured. The third indicator light, FILTER, indicates when the stereo noise filter is in operation. The indicator lights are in three different colors: red for STEREO, amber for LOCK, and green for FILTER.

SELECTIVITY SWITCH

Two degrees of IF selectivity are selectable by the SELECTIVITY switch. The NARROW or normal position provides adequate selectivity for stereo reception even under severe receiving conditions. Five linear phase piezoelectric IF filters provide low distortion reception with this high degree of selectivity. Setting the SELECTIVITY switch to SUPER NARROW adds an additional 4-pole 4-zero quartz crystal filter to the five previously mentioned filters. Use the SUPER NARROW position to receive stations from distant cities which are on channels adjacent to local stations. There may be useable signals which were never heard before with ordinary FM tuners.



SIGNAL COLUMN

A column of LED lamps respond to the signal strength of the station being received. The stronger the signal the higher the column reaches. There is a control on the tuner top panel to adjust the column height for full scale when receiving the strongest signal in your listening area.

FILTER SWITCH AND FUNCTION INDICATOR

The MR 80 FILTER switch provides automatic stereo noise reduction on weak stereo stations. With the switch in the AUTO position the filter will be on only when the station is broadcasting a stereo pilot tone and the signal strength is below 100 microvolts. With the switch in the IN position the filter is connected at all times. The filter has no affect on mono stations. The filter function indicator light glows green when the filter is on.

MODE SWITCH

A two position MODE switch is provided so that you may select either automatic stereo or mono reception. In the STEREO position the tuner automatically switches from mono to stereo mode when a pre-determined signal to noise ratio has

been reached. In the MONO position all stations will be received monophonically but the STEREO indicator will light if the station is broadcasting in stereo.

HEADPHONE JACK

A HEADPHONE jack is provided to drive low impedance dynamic headphones from an internal power amplifier.

SCAN CONTROL

The SCAN control adjusts the speed at which the tuner searches for the next station, when using the AUTO SCAN mode of tuning. If the dial is crowded with stations use a slow scan speed. If there are few stations fast scanning can be used.

MUTING CONTROL

MUTING suppresses the background noise and hiss normally heard between stations. Turning the control counterclockwise to the OUT position disables the muting circuits. Turning the control clockwise increases the signal level required to unmute. This control also adjusts the sensitivity of the AUTO SCAN tuning circuits and the number of stations you will receive when using this tuning mode.

Top Panel Information and Secondary Controls

On the top of the chassis behind the front panel a recessed panel contains the secondary controls. When the MR 80 is installed in the cabinet access to this panel may be gained by depressing the two PANLOC buttons and slipping the unit partially forward.

Preset 1 thru 4

The PRESET tuning adjustments are used to set the received frequency for each preset. To set a preset to the desired station, touch the corresponding preset pad and at the same time adjust the preset control on the top panel for the desired frequency indication. You must touch the pad while tuning to hold the frequency lock circuit inactive, otherwise erroneous tuning will result.

Preselect

The RF PRESELECT switch switches an additional tuned circuit between the antenna and the first RF stage to immunize against overload. Use the preselector in very strong signal areas.

Input

The INPUT switch selects either an antenna or cable as the RF input source. The CABLE input may also be used as a second antenna input.

Lock

This switch will disable the lock circuits only when the main tuning knob is in use. Use the ON position for all normal reception. Switch to the OFF position when the received station has a deep fade. This prevents the frequency lock circuit from changing tuning to lock to an adjacent stronger station.

De-emphasis

The 50/75ms button selects the correct de-emphasis for your country. 75ms is used on the North American continent and 50ms is used in Western Europe and the Far East. 25ms de-emphasis is also available by depressing the button marked

Note: The normal operating position of the five pushbutton switches is for the switches to be in the out or up position.

Signal Strength

Use this control to set the signal strength column to full scale for the strongest station in your area. This control is a sensitivity adjustment for the solid state signal strength indicator. It merely adjusts the height of the column. It does not affect the sensitivity of the tuner.

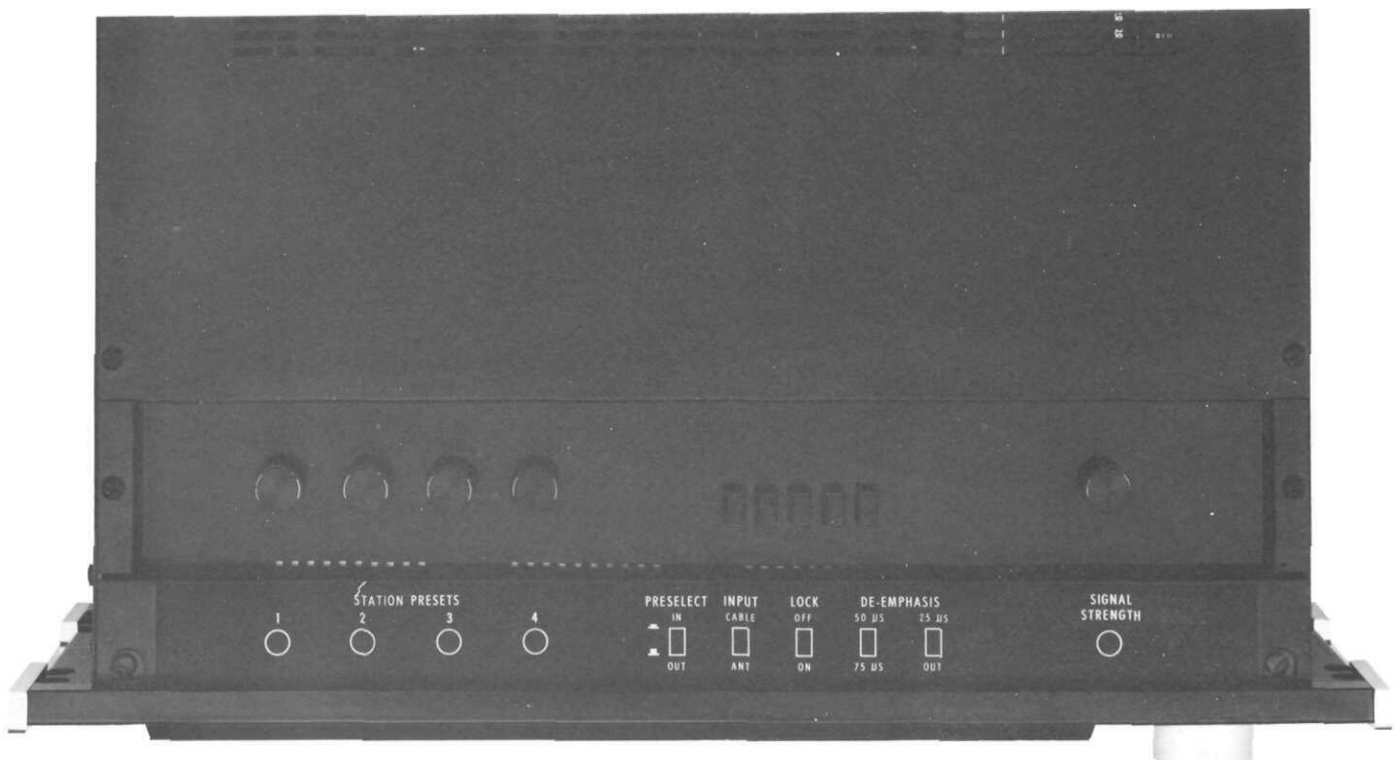

Performance Limits

Performance Guarantee

Performance limits are the maximum deviation from perfection permitted for a McIntosh instrument. We promise you that the MR 80, at the time of its purchase, is capable of performance at or exceeding these limits or you get your money back. McIntosh is the only manufacturer that makes this guarantee.

Tuning:

88 to 108MHz

Antenna Inputs:

One 300W balanced and two 75W unbalanced.

Intermediate Frequency:

10.7MHz

Sensitivity:

9.3dBf (1.6mV) for 35dB of quieting
14.7dBf (3mV) for 50dB of quieting
13.2dBf (2.5mV) for 3% total noise and harmonic distortion

Signal to Noise Ratio:

75dB below 100% modulation

Harmonic Distortion:

0.2% 20Hz to 15kHz, mono or stereo
Typically, 0.08% at 1000Hz

Intermodulation Distortion:

0.15% mono or stereo for any combination of frequencies from 20Hz to 15,000Hz with peak modulation equal to 100% or less. Typically 0.1%

Frequency Response:

Mono and Stereo \pm 1dB 20Hz to 15kHz with 75, 50 or 25mS deemphasis

Capture Ratio:

1.5dB

Selectivity:

	Narrow	Super Narrow
Adjacent channel	8dB	60dB
Alternate channel	90dB	110dB

Spurious Rejection:

110dB

Tuner IM (RF):

-23dBm for 2 signals 1MHz apart

Tuner Intercept Point:

-10dBm 75W

Image Rejection:

90dB

Maximum Signal Input:

8 volts across 75W (1W) antenna terminal will not increase harmonic or intermodulation distortion.

Audio Hum:

75 dB down from 100% modulation

Muting:

70dB noise reduction between stations

Muting Threshold:

2mV to 1000mV

SCA Rejection:

60dB minimum

Stereo Separation:

50dB to 1000Hz

Stereo Filter:

10dB noise reduction

Audio Output:

Variable:

2.5V into 47k

Fixed:

1V into 47k

General Information

Power Requirements:

120 volts 50/60Hz. 25 watts

Semiconductor Complement:

57 Transistors

68 Integrated Circuits

81 Diodes

4 LED Displays

18 LED's

7 Neon Lamps

Mechanical Information

SIZE: Front panel measures 16 inches wide (40.6 cm) by 5 7/16 inches high (13.8 cm). Chassis measures 14 3/4 inches wide (37.5 cm) by 4 13/16 inches high (12.2 cm) by 13 inches deep (33 cm), including connectors. Knob clearance required is 1 1/4 inches (3.2 cm) in front of mounting panel.

FINISH: Front panel is anodized gold and black with special gold/teal nomenclature illumination. Chassis is black.

MOUNTING: Exclusive McIntosh developed professional PANLOC

WEIGHT: 27 pounds (12.2 kg) net, 39 pounds (17.7 kg) in shipping carton

Performance Charts

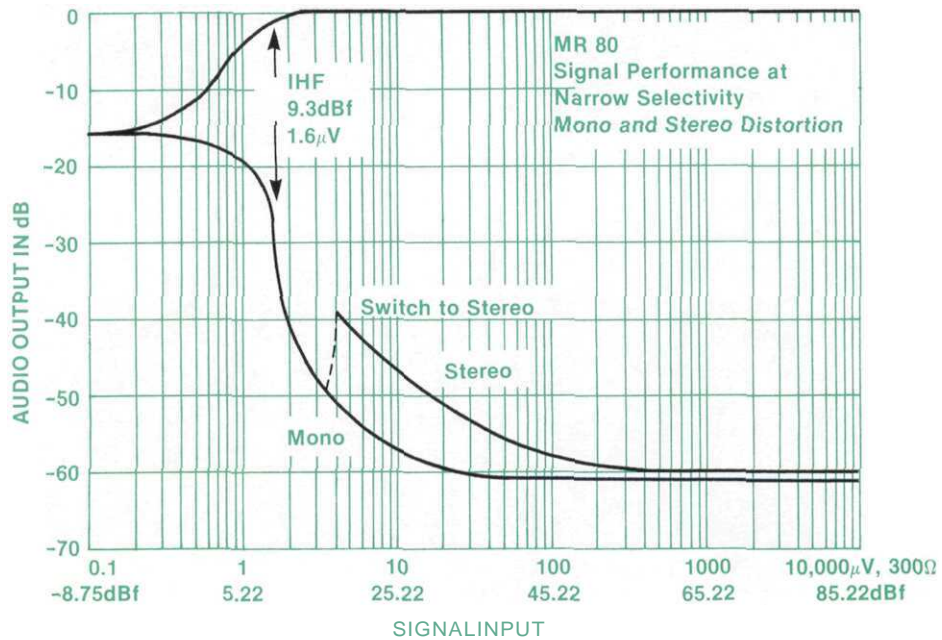
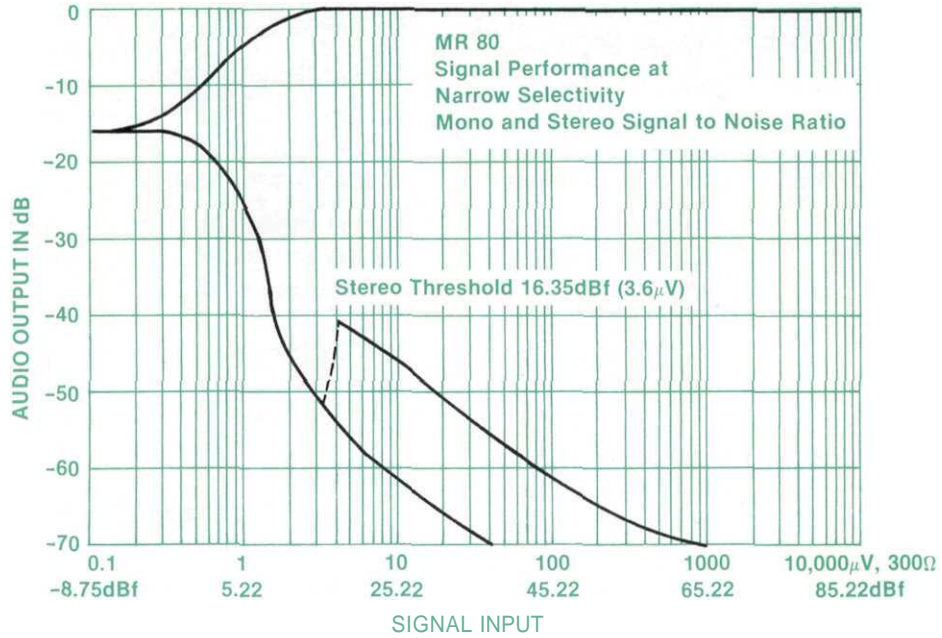

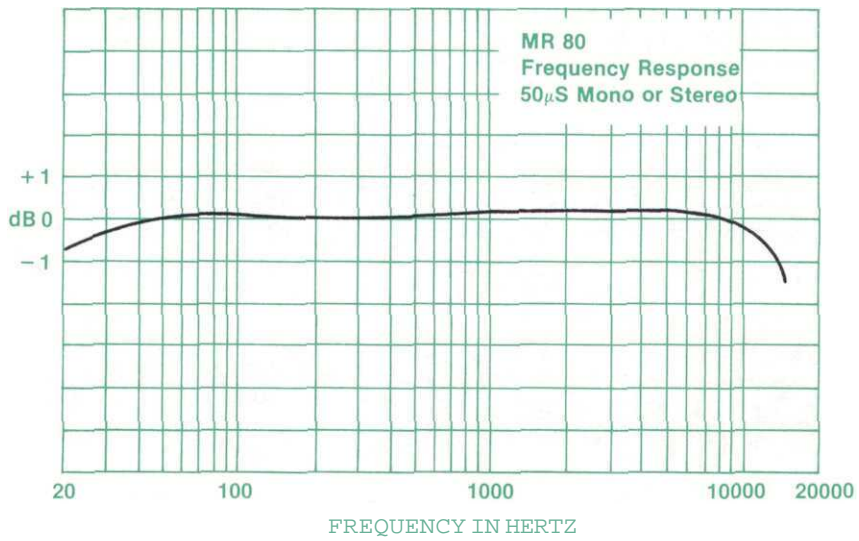
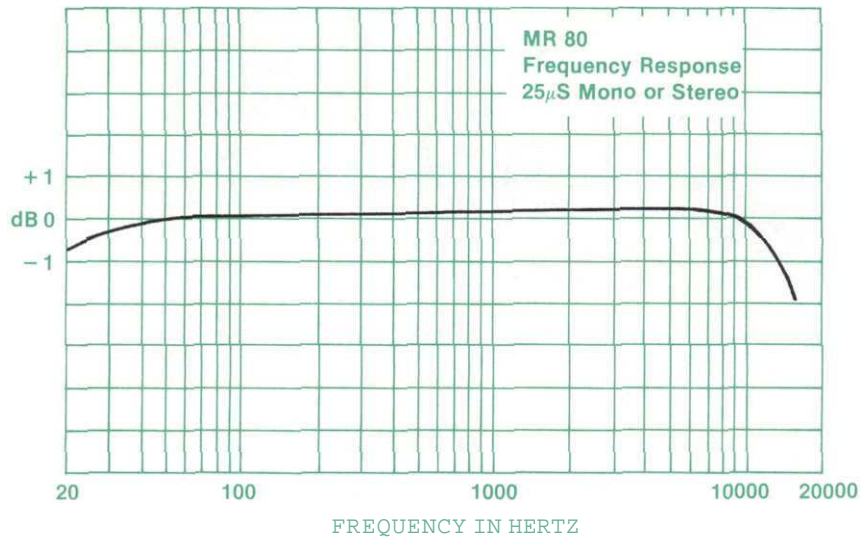
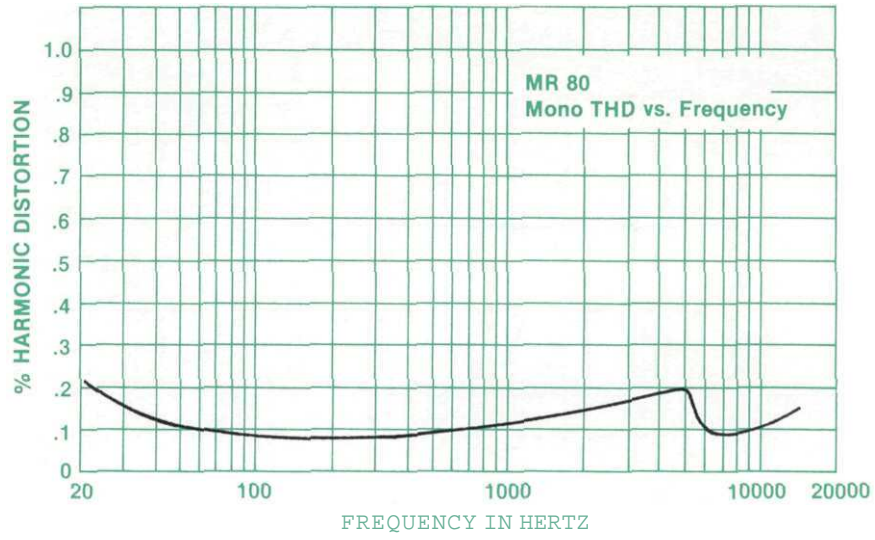

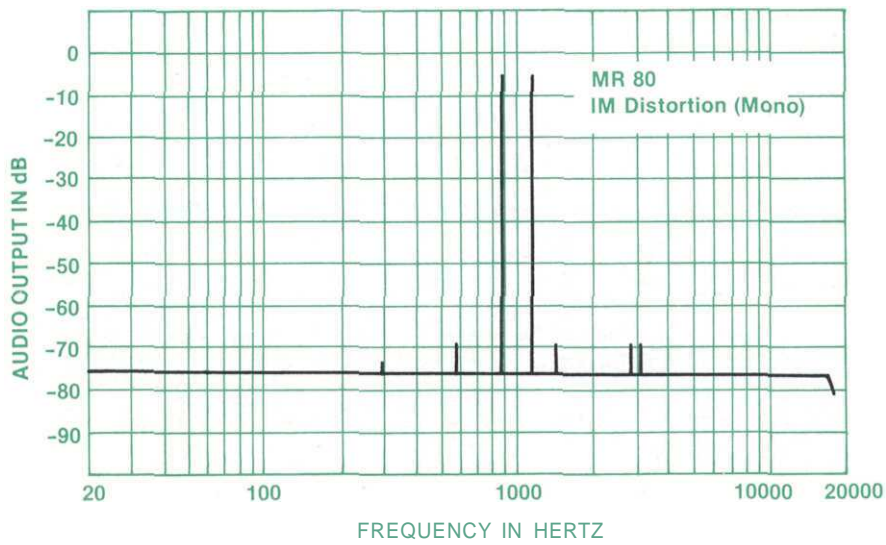
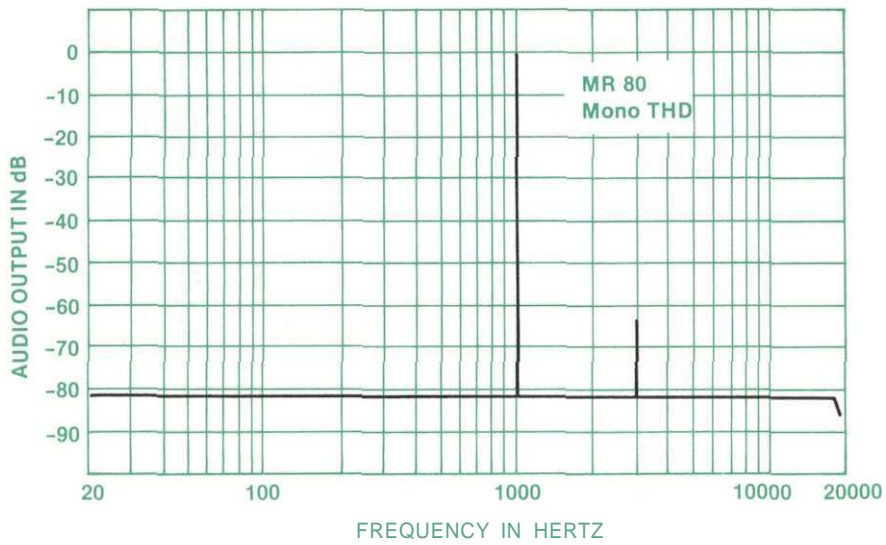
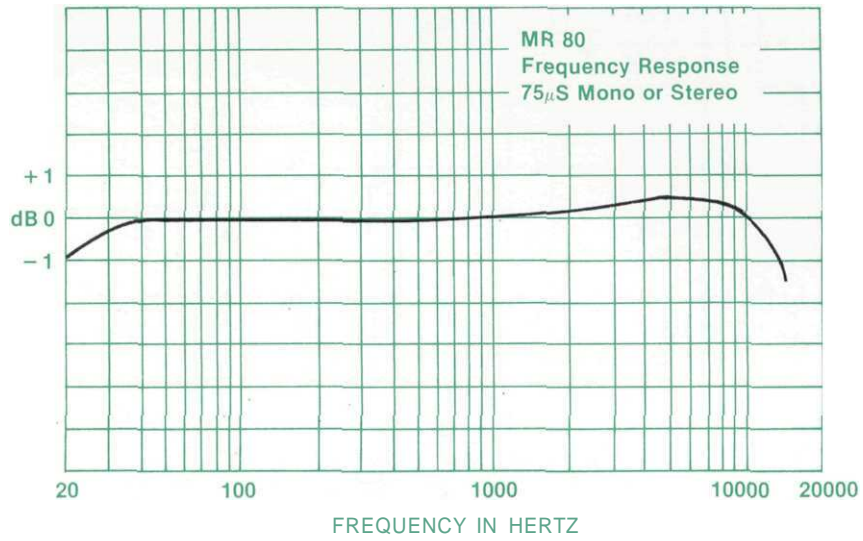

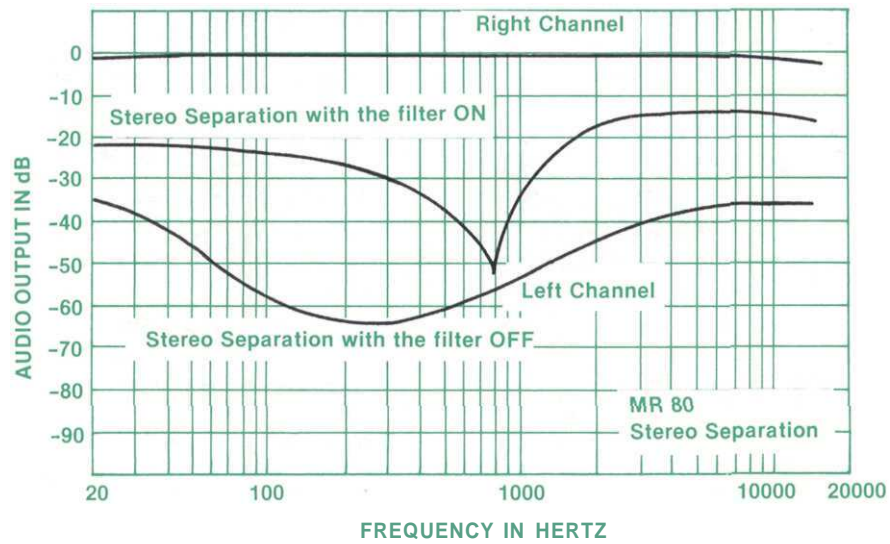
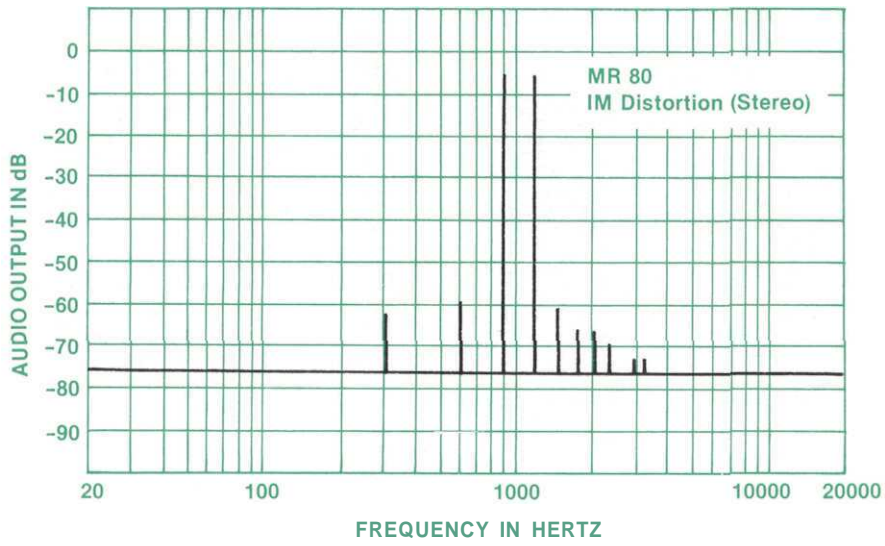
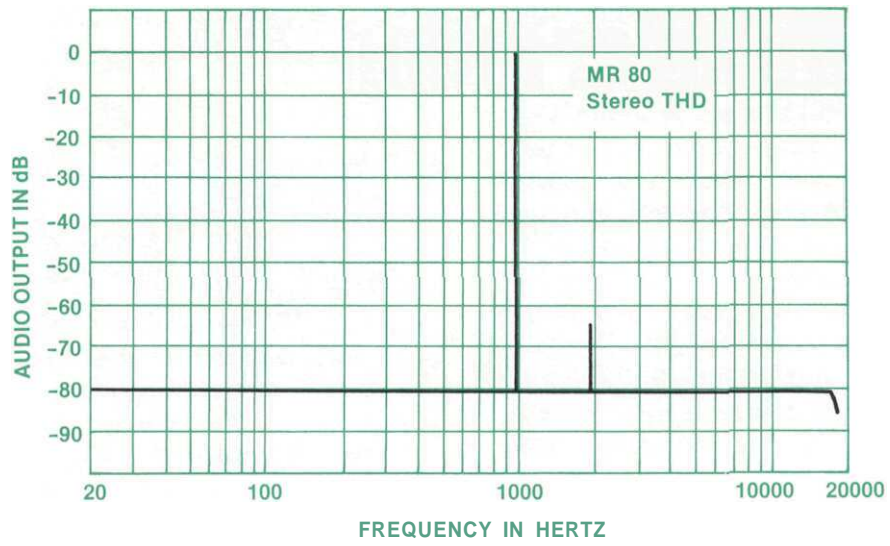

Technical Description

Engineering direction dictated a tuner design governed by insistence on great flexibility and ease of use. This had to be done while designing an RF section with great sensitivity and the world's best selectivity in keeping with the needs of low distortion. These values were achieved and they retain the McIntosh reputation of outstanding performance, long life and reliability.

RF-IF SECTION

In the ANT SWITCH six RF PIN diodes are connected as a single pole double throw switch. This allows the use of two antennas or the use of an antenna and a cable. Input to output isolation of this switch is greater than 75dB.

Following the ANT SWITCH is an RF tuner of exceptional performance. This performance is achieved by the use of a low noise junction FET and a high power bipolar transistor (a heatsink is used) connected as a cascode amplifier. This connection allows high gain, low noise, and high output levels without the need for neutralization. Two additional PIN diodes are used to insert a second tuned antenna Preselector circuit during strong signal reception. For lower intermodulation distortion the tuned circuits are tuned by a series parallel connection of four matched varactor diodes. This circuit and the high tuning voltage (5-26 volts) eliminates the RF intermodulation distortion caused by diode nonlinearities.

After the RF amplifier two parallel tuned circuits are used to provide the proper load impedance for the bipolar transistor. The use of two tuned circuits at this location greatly improves the image rejection and overload performance of the tuner, as well as increasing the RF selectivity.

The following balanced mixer is a matched dual J-FET and bipolar transistor circuit. A low loss toroidal phase splitting transformer is used as an impedance matching network in the gate circuit of the mixer. At the output a balanced double tuned transformer is used as the drain load. This arrangement gives great immunity to mixer overload in the presence of a very strong signal. A bipolar transistor is used as an oscillator buffer to prevent oscillator pulling on strong signals, and as the constant current source for the dual J-FET mixer.

The MR 80 has the narrowest IF bandwidth ever used in a stereo tuner. It is the correct width to let just one FM station through. The excellent selectivity of the MR 80 (210kHz wide at 60dB down) permits tuning to stations that are impossible to receive on ordinary tuners.

Constant delay design techniques are used in the 4-pole 4-zero crystal filter used in the SUPER NARROW position. However, due to the extreme selectivity, delay distortion is very slightly increased over the NARROW selectivity position.

Four differential amplifiers, coupled with PHASE-LINEAR monolithic filters, comprise the NARROW selectivity and signal strength sections of the IF amplifier. One half of each differential amplifier output drives a filter and the second output drives a full wave rectifier circuit. The outputs of these four rectifier circuits are summed at the inverting input of an operational amplifier. A fifth rectifier circuit that is driven from the limiter is also summed at the input to the operational amplifier. The output of the operational amplifier is a voltage that is proportional to the log of the RF input level. Dynamic range is from 2mV to over 2V, that is, greater than 120dB. A solid state signal strength meter is used as a front panel indication of the incoming RF signal level. Twelve LED's are used in place of the conventional meter movement. The LED's have an almost unlimited life. The fast response of the LED's plainly shows multipath signals and antenna misorientation. To better use the wide dynamic range of the five signal strength detectors, an adjustment is provided to reduce the full scale signal from 100,000mV to any value below that. This meter can be set to give a full scale indication on a signal as low as 2mV. This allows setting the signal meter to indicate full scale on the strongest station in the users area. Then the signal strength meter indicates the RF level of all stations received relative to the strongest in the listener's area.

The signal strength voltage is also used to control mono/stereo switching, stereo filter insertion, muting, and automatic scan stop. Because of its wide range and high repeatability this control voltage is also used to adjust the stereo separation at low RF signal levels. This produces the maximum signal to noise ratio possible for all signal levels.

Following the selectivity section of the IF amplifier is the LIMITER. A total gain of 80dB is used in this circuit. The use of very high gain in the limiter circuit produces hard limiting with very good impulse noise rejection. Limiter bandwidth is greater than 50MHz, producing excellent detector capture characteristics.

A broadband Foster-Seeley discriminator is used as the detector. This detector coupled with the broadband limiter produces unmeasurable noise and distortion. A high speed buffer amplifier following the detector isolates the detector from all varia-

tions in load impedance. This prevents changes in audio cable lengths outside the tuner from affecting the detector performance.

FM STEREO MULTIPLEX

The heart of the multiplex section is a new third generation phase locked loop (PLL) stereo decoder integrated circuit (IC). This PLL IC incorporates two special systems, an automatic variable separation control circuit to reduce background noise when receiving weak stereo stations, and tri-level digital waveform generation which eliminates interference from SCA signals and from the sidebands of adjacent channel FM signals.

The variable separation control is operated from the IF amplifier's signal strength detector. A smooth transition is provided from mono to stereo or from stereo to mono at weak signal levels to provide the optimum signal to noise ratio and best stereo separation for the prevailing signal conditions. The circuit operates only during stereo reception. It switches automatically to monophonic if the 19kHz pilot tone is absent.

In the PLL the internal oscillator operates at 228kHz, locked onto the 19kHz pilot tone. The 228kHz feeds a 3 stage Johnson counter via a binary divider to generate a series of square waves. Suitably connected NAND gates and exclusive OR gates produce the tri-level drive waveform for the various demodulators in the circuit. The usual square waveforms have been replaced in the PLL and decoder sections by tri-level waveforms. These tri-level forms contain no harmonics which are multiples of 2 or 3. This eliminates frequency translation and detection of interference from the side-bands of adjacent stations since the third harmonic of the sub-carrier (114kHz) is excluded. It also eliminates interference from SCA broadcasts since the third harmonic of the pilot tone (57kHz) is excluded. Unwanted spurious audible components and phase jitter in the PLL are inherently eliminated by this technique.

Additional advantages of the phase locked loop stereo demodulation are the elimination of inductors to minimize drift, integral lamp driving capability to indicate the presence of the 19kHz pilot carrier, excellent channel separation over the entire audio frequency range, extremely low distortion, low output impedance, and transient-free mono/stereo switching.

AUDIO CIRCUITS

Following the MPX decoder is the three position deemphasis switch. The three different positions allow the MR 80 to be used in North America with standard 75ms deemphasis and in Western Europe and the Far East with 50ms deemphasis. The 25ms position is for use with an external noise reduction adapter.

An electronically switched filter circuit, implemented with two J-FETs of a quad J-FET package, is used to reduce out of phase noise when in the stereo mode and tuned to a weak station. This filter is actually a twin-T bandpass that blends the high and low frequencies, leaving separation unaffected at mid-frequencies. This results in a greatly improved stereo image when the filter is required.

A combination of three inputs are used to control the switch point of the filter. The first is the front panel switch. The filter is only active when this switch is in the AUTO or ON position. In the ON position the filter is in the circuit for all stations mono or stereo. In the AUTO position the filter will switch in when the station is transmitting a stereo pilot signal and the signal strength is below 100mV.

In the same quad J-FET package are the two FETs that are used for the muting circuit. These FETs are controlled by the logical ANDing of three signals. The first signal is the deviation or center tune, this detects when the tuner is correctly tuned to the center of the FM channel. The second signal is the signal to noise ratio. Only when there is sufficient signal will the tuner be allowed to unmute. Signal to noise ratio is measured by a special bandpass amplifier centered around 138kHz. This frequency is used to prevent false triggering due to adjacent channel and overmodulation products. The third signal is the RF signal level that is derived from the five signal detector circuits. A front panel control (MUTING LEVEL) adjusts the reference level to a voltage comparator. The other input to the comparator is the signal strength voltage. When the RF level exceeds the preset reference level, a signal is sent to the muting logic to be ANDed with the other two signals. This adjustment allows the unmute level to be set to any value from 2mV to greater than 1000mV.

This wide range is necessary for the tuner to scan properly in all signal conditions and provide the best combination of ease of use with maximum interstation noise suppression.

19 AND 38kHz FILTER

An LC tuned notch filter is used to eliminate any beatnote interference with the bias oscillator in a users tape recorder. This filter is driven from a filter buffer amplifier and terminated by the output operational amplifier. These amplifiers provide the necessary input and output impedances for proper phase response. The output amplifier is also used as an audio bandpass filter to prevent unwanted noise and transients from being passed on to the headphone amplifier.

HEADPHONE AMPLIFIER

The headphone amplifier is capable of driving a pair of dynamic headphones with less than .02%

harmonic distortion. Because of its extremely low THD and power capability, it is also the main output amplifier.

TOUCH SENSOR

The touch sensor consists of three functional elements: 1) Input buffers and static protection circuits. 2) Latches, and 3) Encoder. The seven sensors: KNOB, PRESET 1 to 4, UP and DOWN SCAN are inputs to the seven input buffer amplifiers. These perform a dual function. First the inputs are biased to a high level by a very high resistance. Second the buffers are designed to detect a negative transition from a reference level. When a sensor is touched, the stray capacity of the human body shunts some of this reference signal to ground. This reference signal is derived from the 228kHz oscillator on the multiplex circuit board. This means all noise components of the reference signal are a multiple of 19kHz, and will be filtered out by the 19 and 38kHz filters. The second phase of this reference signal is used to transfer the output of the buffer amplifiers into the latches. The latches are used as temporary storage to prevent false triggering due to static and voltage transients.

The output from the latched inputs are supplied to the encoder, which performs two functions. First, it puts in order the inputs, assigning highest priority to the tuning knob and the lowest to the down scan sensor. Second, it encodes the input with the highest priority into a binary coded decimal word and outputs this to the decoder circuit. This decoder reconverts the BCD word back into a 1 of seven line code, indicating the sensor that is touched. An additional input to the decoder is the reference phase input that inhibits the decoder during clock edge transitions. This is done to prevent false triggering due to noise glitches and partial contact with the touch sensor.

PRESET SCAN

The seven outputs from the touch control and decoder go to the preset scan circuits. In the preset scan is an electronic switch and a counter. A switch on the rear panel selects whether the tuner scans all stations or only the preset stations. The circuit operates in the preset scan mode as follows: When a pulse is received at the rear panel connector the counter is indexed by one, then the seven pole double throw switch connects the input to the tuning control logic to the output of the counter. The control logic then selects the preset that is represented by the counter output. At the end of the pulse the counter is disconnected and the lock circuit automatically fine tunes the tuner to the center of the channel.

When in the scan all stations mode, the input pulse is routed to the scan circuitry on the tuning

control logic board. The logic circuitry will then select the auto scan circuit and start searching for the next acceptable station. The direction of scan will be the last selected scan direction and will change when the band limit is reached.

The remote input to the tuner is a ground asserted logic level that is normally at + 15 volts. When this line is grounded the tuner will start scanning. The use of this logic permits any number of remote cables to be connected to the MR 80.

CONTROL LOGIC

The control logic portion of the tuner is made up of very low power complementary MOS integrated circuits. By using this logic family a very significant power reduction was realized in the design. With the lower power consumption, a very real reduction in the operating temperature and an improvement in the operating life is achieved.

A very important consideration in the design of a digital tuner is the amount of radiated noise from the digital integrated circuits. To achieve low noise the control logic was made to operate in a static mode to entirely eliminate any interference. This allows the control logic board to be built without the shielding necessary to reduce interference.

The seven touch sensor inputs from the preset scan board are stored in eight C-MOS flip-flop's. The state of the flip-flop's indicate which input was active last. One bit is used for the main tuning knob, 4 bits are used to represent the 4 presets. The scan circuitry uses 3 bits to tell if the scan is on or off, set to scan up or down, and the third is set to a zero when the tuner reaches an acceptable station. This complex group of circuits provides a level of sophistication and ease of operation not possible before in a tuner.

Several timing circuits are used to provide the various time sequences and delays for the proper noise free operation of the preset and scan circuits. The first of these monostable circuits is used as a power on clear that resets the circuits to the main tuning knob mode. During the four second delay the lock circuit is inhibited and the high speed muting input to the multiplex is held high to mute the tuner and prevent any noise or transient from affecting the rest of the users system. At the completion of this four second delay the lock circuit is enabled, locking the tuner to the incoming frequency and unmuting the tuner.

When one of the four presets is activated, the display and audio are inhibited for two seconds from when the sensor is touched. The lock circuit is disabled during the time the sensor is touched, to allow the presets to be set to the proper frequency. When the sensor is released the lock circuit then tunes to the center of the FM station. During normal operation (not setting of the presets) the touch sen-

sor reacts in a small fraction of a second so the tuner appears to change stations instantaneously, without any interstation noise even with the muting turned off.

When either of the scan sensors is touched the tuner is muted and the display blanked for two seconds, this allows the tuner to reach the next station under normal listening conditions without any interstation noise. If the scan speed is set to a slow setting and the muting is turned off, interstation noise and very weak stations will be heard after the two second delay, which is very useful when remote tuning is used.

Driven from the tuning control logic are six LED lamps. Four are used to indicate which of the presets are in use. The other two lamps indicate the direction of scan. These six lamps and the frequency display indicate at a glance how the tuner is operating and what preset or scan direction has been chosen.

LOCK CIRCUIT

An innovative new circuit was developed for use in the MR 80. This new circuit allows correct tuning without the use of a center tune meter. The MR 80 will be correctly tuned even if the station or the cable company is not on its correct frequency. This is done by the use of two operational amplifiers,

A deviation signal from the detector is fed into the first amplifier. This circuit is a log amplifier that produces an output voltage proportional to the log of the DC component in the detector output. Because the output voltage contains audio signals, a second amplifier, connected as a switched gain low pass filter, removes the audio signals. This amplifier has a very high gain when the lock circuit is on and unity gain when the lock circuit is off. An N-channel J-FET is used as the gain switching element in the negative feedback path. The filter output, now called the correction voltage, is fed into a scaling circuit that compensates for the tuning diodes nonlinear frequency to voltage response. Both of the amplifiers operate with greater than 50dB of gain at DC. With a closed loop gain of greater than 100dB the tuning error when locked is less than 1kHz at 100MHz, or 1 part in 100,000. This error is the same as a crystal controlled synthesizer with the additional benefit of being correctly tuned even if the station or the cable signal is not on the proper frequency.

Because the lock circuit will track a station even if it drifts 1MHz, the lock circuit must be turned off for the operator to be able to tune the MR 80. This is the reason for the touch sensor on the main tuning knob. To prevent the tuner from locking onto a strong signal next to a weak signal, a circuit is used to sense the strong adjacent channel signal and inhibit the lock circuit under these conditions. On the

top cover control panel is a manual lock ON/OFF switch that inhibits the lock circuit only if the tuner is in the main tuning knob mode. This provision is made for testing the tuner and for cases where the station being received has a deep fade to the point of losing lock. If the switch is set to the off position the lock circuit will work normally for all the presets and the scan circuit, but not for the tuning knob.

SCAN CIRCUIT

With the voltage tuned RF section, automatic scanning is implemented without any moving parts such as motors, flywheels, or strings. By the elimination of all moving parts, a much greater degree of reliability is achieved and tuning convenience improves.

The MR 80 scan circuit consists of five sections: 1) switching circuit; 2) bipolar current source; 3) integrator; 4) band limit detector; and 5) the auto-track circuit. The scan switching circuit controls the scan function by switching two flip-flops, the scan on/off flip-flop and the scan run/stop flip-flop. When either of the scan buttons or the remote control starts a scan cycle, the preset buttons and tuning knob circuits are switched off, the lock circuit is inhibited, the display is blanked, the audio is muted, and the scan on/off flip-flop turns on. The display is blanked and the audio is muted for two seconds. The scan on/off flip-flop switches the RF tuning control to the scan ramp voltage.

Depending on the scan sensor touched, the bipolar current source is set to the proper value (negative for scan up, positive for scan down). This current is adjusted by the front panel SCAN SPEED control for the proper search speed. The run/stop flip-flop stops or starts the scan sequence. This flip-flop is set whenever a scan stop signal is sent from the multiplex. To reset the flip-flop one of the scan sensors must be touched.

In the integrator portion of the scan circuit the current is converted into a time dependent ramp voltage until a stop signal is received from the multiplex. When the tuner has stopped on a station the tuning voltage is stored on a special low leakage capacitor. To prevent drift due to leakage currents, guard tracks were employed around the negative input to the integrator operational amplifier. This amplifier is a special type with MOS-FET input transistors that have an input resistance of greater than 100 million megohms. With special circuit components and printed circuit layout, drift in the scan circuit has been eliminated. The positive input to the operational amplifier is used as the input for the lock correction voltage. The correction voltage is only applied after the tuner has stopped scanning and fine tunes the tuner to the center of the station.

Two comparators connected to the tuning voltage input in the RF section are used for band limit detec-

tion. The comparators sense when the tuning voltage exceeds the value needed for 87.5 or 108.1MHz and generates a pulse that toggles the flip-flop controlling the bipolar current source, changing the direction of scan. If a person attempts to scan past the band ends, both scan indicators will light and the tuner will hang at the band limit until the sensor is released.

When any of the presets or the tuning knob are active the auto track circuit is used to force the output of the integrator to a value equal to the current tuning voltage. During the turn on delay the auto track ensures that the integrator's output voltage is within the band limits. This circuit allows the tuner to start searching for the next station from the current location.

FREQUENCY COUNTER

The counter and display form the digital equivalent to the slide rule dial and pointer, but with greater accuracy and readability. In the RF section a small portion of the oscillator signal is coupled into the buffer amplifier on the counter circuit board. This buffer amplifier is made with emitter coupled logic circuits and is used to change the small oscillator signal into a level acceptable by the high speed ECL divide-by-four circuit. The output of the divider is level shifted to low power Schottky levels for use in the rest of the counter circuit. The divided local oscillator signal is sampled for 40.96mS by a synchronous gate, made from a J-K flip-flop to eliminate the ± 1 count error. The actual counting is done by low power Schottky integrated decade counters. IF frequency offset is accomplished by presetting the counters to the complement of the IF frequency, 893. This allows subtracting the IF offset by adding the negative of the IF frequency.

The gate signal is derived from a stable 200kHz crystal oscillator and a binary divider made from LS integrated circuits. Two other signals are derived from the divider chain. The first is used to transfer the information in the decade counters to the display buffer. The second is used to reset the counter to the complement of the IF frequency.

In the display portion, three TTL integrated circuits are used as a latch to store the frequency information and as constant current sources to drive the LED frequency displays. By using the latches, a flicker free display is assured even when the display is changing. The constant current sources improve reliability by reducing the number of components. LED displays were used because of their visibility, character font, and very long life.

POWER SUPPLY

Special design attention has been given to the power supply section. Nine separate power circuits are used. Six of these are regulated to prevent loss of performance during a brown out. The - 15, - 5.2.

5, 15 and 30v use integrated circuit 3 terminal regulators, while the 3ma current source is made with discrete transistors because of the high voltage on the input terminal. The remaining voltages are used for the headphone amplifier and the touch control reference signal driver.

LAMP DRIVERS

McIntosh, recognizing the need for improved reliability, has designed a new circuit to drive incandescent lamps. This new circuit prevents the filaments from failing due to notching when operated on direct current. This failure mode can reduce lamp life from one half to one tenth of the data sheet value. In the MR 80 the three lamps that are used for STEREO, LOCK and FILTER indicators are operated on AC at lower than rated voltage to extend the useful life to well in excess of 15 years. Only McIntosh brings you this feature.



Block Diagram

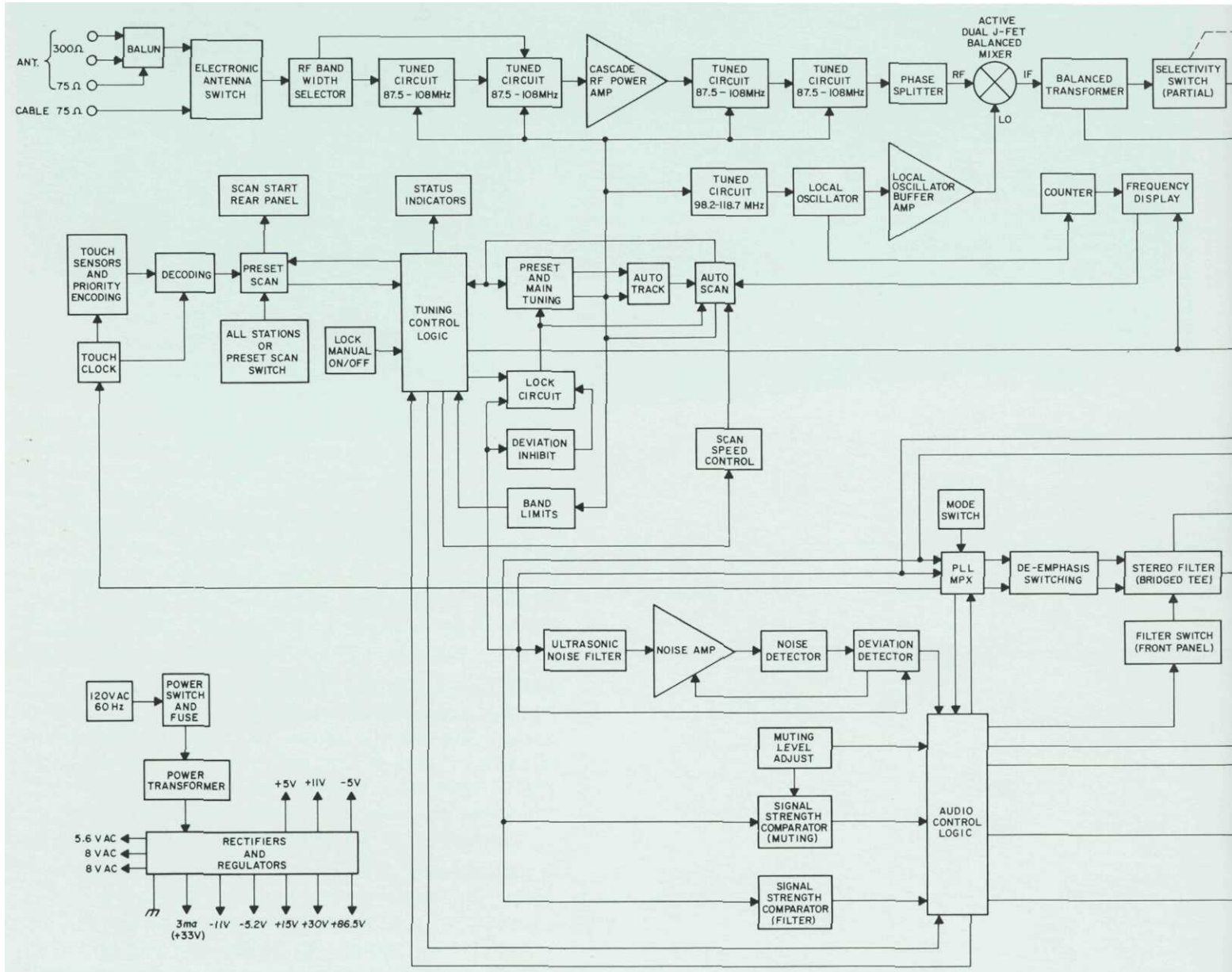

McINTOSH MR 80

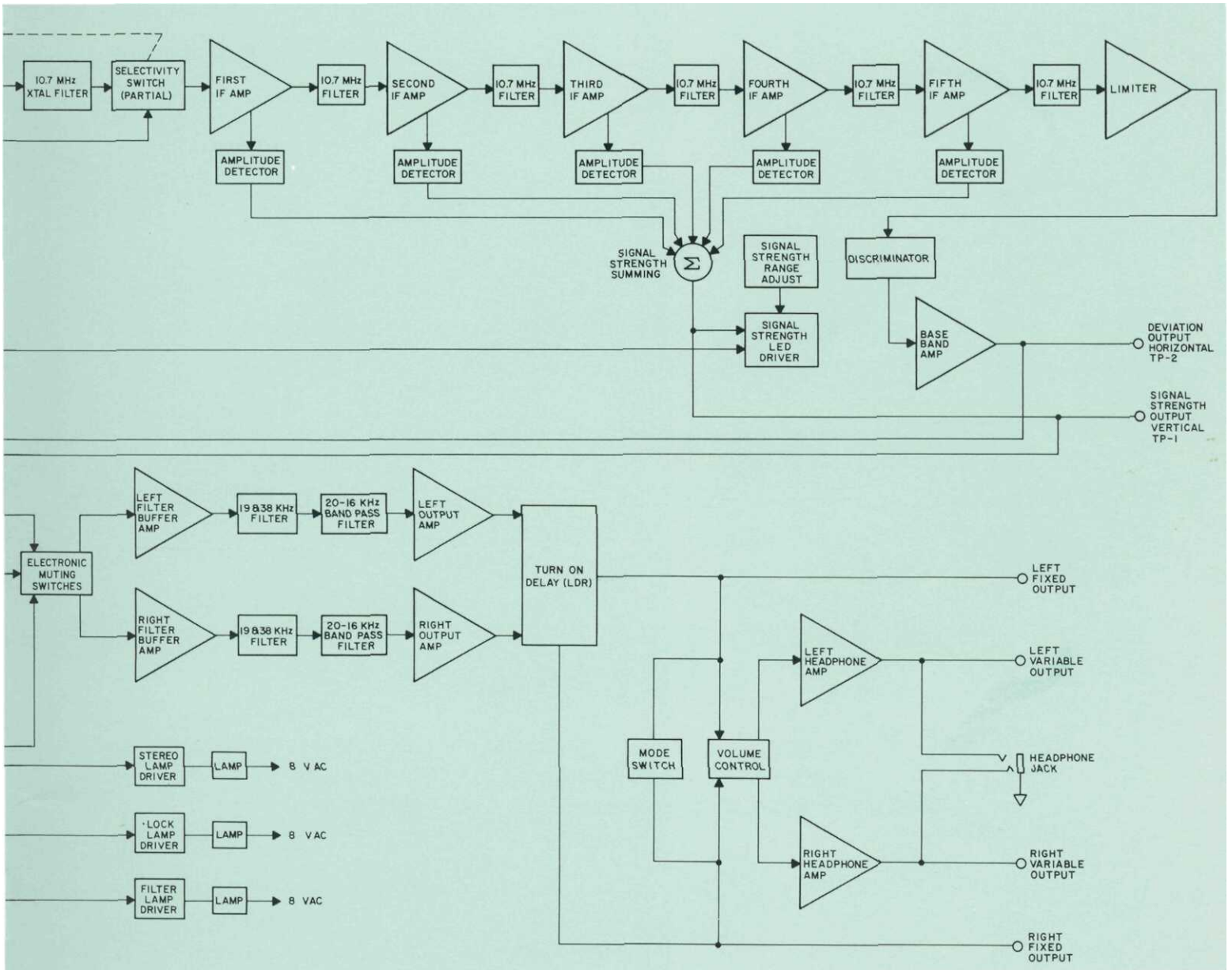

DIGITAL FM TUNER

McIntosh

**McINTOSH LABORATORY INC.
2 CHAMBERS ST., BINGHAMTON, N.Y. 13903-9990
607-723-3512**

The continuous improvement of its products is the policy of
McIntosh Laboratory Incorporated who reserve the right to
improve design and price without notice.

Printed in U.S.A.