

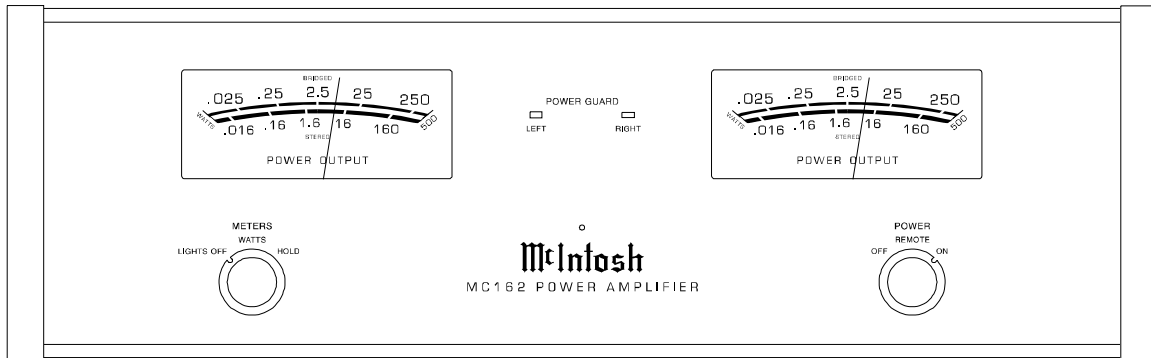

## MC162 Power Amplifier



MC162



## Thank You, Please Take A Moment, Customer Service and Table of Contents

### Thank You

For your decision to own this McIntosh MC162 Power Amplifier ranks you at the very top among discriminating music listeners. You now have "The Best." The McIntosh dedication to "Quality," is assurance that you will receive many years of musical enjoyment from this unit.

Please take a short time to read the information in this manual. We want you to be as familiar as possible with all the features and functions of your new McIntosh MC162. This will ensure that you receive all the performance benefits this equipment can offer you, and that it will become a highly valued part of your home entertainment system.

### Please Take A Moment

The serial number, purchase date and McIntosh dealer name are important to you for possible insurance claim or future service. The serial number is located on the rear panel of the equipment. The spaces below have been provided for you to record that information:

**Serial Number:** \_\_\_\_\_

**Purchase Date:** \_\_\_\_\_

**Dealer Name:** \_\_\_\_\_

### Customer Service

If at any time you have questions about your McIntosh MC162 Power Amplifier, contact your McIntosh dealer. Your dealer is familiar with your McIntosh equipment as well as other brands that may be included in your system and is best qualified to help you.

If it is determined that your MC162 is in need of repair, you can return it to your dealer or you can return it to McIntosh Laboratory. Contact the McIntosh Repair Department for assistance at,

McIntosh Laboratory, Inc.  
2 Chambers Street  
Binghamton, New York 13903  
Phone: 607-723-3512  
FAX: 607-724-0549

### Table of Contents

|   |    |
|---|----|
| Thank You .....                           | 2  |
| Please Take a Moment .....                | 2  |
| Customer Service .....                    | 2  |
| Table of Contents .....                   | 2  |
| Safety Instructions .....                 | 3  |
| Introduction .....                        | 4  |
| Performance Features .....                | 4  |
| Installation .....                        | 5  |
| Rear Panel Controls and Connections ..... | 6  |
| How to Connect .....                      | 7  |
| Front Panel Displays and Controls .....   | 8  |
| How to Operate .....                      | 9  |
| Specifications .....                      | 10 |
| Packing Instruction .....                 | 11 |

#### NOTES:

1. *Connecting Cables are available from the McIntosh Parts Department:  
**Data and Power Control Cable Part No. 170-202**  
Six foot, shielded 2 conductor, with 1/8 inch stereo mini phone plugs on each end.*
2. *For additional connection information, refer to the owner's manual(s) for any component(s) connected to the MC162 Amplifier.*
3. *There is a built-in turn on delay which will mute the speaker outputs for approximately two seconds when the amplifier is turned on.*
4. *It is very important that loudspeaker cables of adequate size be used in your music system, to ensure that there will be no power loss or heating. Cable size is specified in Gauge numbers or AWG, (American Wire Gauge). The smaller the Gauge number, the larger the wire size:  
If your loudspeaker cables are 25 feet (7.62m) or less, use at least 18 Gauge (AWG) wire size or larger.  
If your loudspeaker cables are 50 feet (38.1m) or less, use at least 16 Gauge (AWG) wire size or larger.  
If your loudspeaker cables are 100 feet (76.2m) or less, use at least 14 Gauge (AWG) wire size or larger.*

## IMPORTANT SAFETY INSTRUCTIONS!

**PLEASE READ THEM BEFORE OPERATING THIS EQUIPMENT.**



### **WARNING SHOCK HAZARD - DO NOT OPEN.**

The lightning flash with arrowhead, within an equilateral triangle, is intended to alert the user to the presence of uninsulated "dangerous voltage" within the product's enclosure that may be of sufficient magnitude to constitute a risk of electric shock to persons.



### **AVIS RISQUE DE CHOC - NE PAS OUVRIR.**

The exclamation point within an equilateral triangle is intended to alert the user to the presence of important operating and maintenance (servicing) instructions in the literature accompanying the appliance.



**NO USER-SERVICEABLE PARTS INSIDE. REFER SERVICING TO QUALIFIED PERSONNEL**



To prevent the risk of electric shock, do not remove cover (or back). No user serviceable parts inside. Refer servicing to qualified personnel.

#### **General:**

1. Read all the safety and operating instructions, contained in this owner's manual, before operating this equipment.
2. Retain this owner's manual for future reference about safety and operating instructions.
3. Adhere to all warnings and operating instructions.
4. Follow all operating and use instructions.
5. **Warning: To reduce risk of fire or electrical shock, do not expose this equipment to rain or moisture. This unit is capable of producing high sound pressure levels. Continued exposure to high sound pressure levels can cause permanent hearing impairment or loss. User caution is advised and ear protection is recommended when playing at high volumes.**
6. **Caution: to prevent electrical shock do not use this (polarized) plug with an extension cord, receptacle or other outlet unless the blades can be fully inserted to prevent blade exposure.**

**Attention: pour prevenir les chocs electriques pas utiliser cette fiche polarisee avec un prolongateur, une prise de courant ou un autre sortie de courant, sauf si les lames peuvent etre inserees afond ans en laisser aucune partie a decouvert.**

7. For added protection for this product during a lightning storm, or when it is left unattended and unused for long periods of time, unplug it from the wall outlet and disconnect the antenna or cable system. This will prevent damage to the product due to lightning or power line surges.
8. Do not use attachments not recommended in this owner's manual as they may cause hazards.

#### **Installation:**

9. Locate the equipment for proper ventilation. For example, the equipment should not be placed on a bed, sofa, rug, or similar surface that may block ventilation openings; or, placed in a built-in installation, such as a bookcase or cabinet, that may impede the flow of air through the ventilation openings.
10. Locate the equipment away from heat sources such as radiators, heat registers, stoves, or other appliance (including amplifiers) that produce heat.
11. Mount the equipment in a wall or cabinet only as described in this owner's manual
12. Do not use this equipment near water; for example, near a bathtub, washbowl, kitchen sink, laundry tub, in a wet basement or near a swimming pool, etc.
13. Do not place this product on an unstable cart, stand, tripod, bracket, or table. The equipment may fall, causing serious injury to a person, and serious damage to the product.

#### **Connection:**

14. Connect this equipment only to the type of AC power source as marked on the unit.
15. Route AC power cords so that they are not likely to be walked on or pinched by items placed upon or against them, paying particular attention to cords at plugs, convenience receptacles, and the point where they exit from the instrument.
16. Do not defeat the inherent design features of the polarized plug. Non-polarized line cord adapters will defeat the safety provided by the polarized AC plug. If the plug should fail to fit, contact your electrician to replace your obsolete outlet. Do not defeat the safety purpose of the grounding-type plug.



17. Do not overload wall outlets, extension cords or integral convenience receptacles as this can result in a risk of fire or electric shock.

**Care of Equipment:**

18. Clean the instrument by dusting with a dry cloth. Unplug this equipment from the wall outlet and clean the panel with a cloth moistened with a window cleaner. Do not use liquid cleaners or aerosol cleaners.
19. Do not permit objects of any kind to be pushed and/or fall into the equipment through enclosure openings. Never spill liquids into the equipment through enclosure openings.
20. Unplug the power cord from the AC power outlet when left unused for a long period of time.

**Repair of Equipment:**

21. Unplug this equipment from the wall outlet and refer servicing to a qualified service personnel under the following conditions:
  - A. The AC power cord or the plug has been damaged.
  - B. Objects have fallen, or liquid has been spilled into the equipment.
  - C. The equipment has been exposed to rain or water.
  - D. The equipment does not operate normally by following the operating instructions contained within this owner's manual. Adjust only those controls that are covered by the operating instructions, as an improper adjustment of other controls may result in damage and will often require extensive work by a qualified technician to restore the product to its normal operation.
  - E. The equipment has been dropped or damaged in any way.
  - F. The equipment exhibits a distinct change in performance - this indicates a need for service.
22. Do not attempt to service beyond that described in the operating instructions. All other service should be referred to qualified service personnel.
23. When replacement parts are required, be sure the service technician has used replacement parts specified by McIntosh or have the same characteristics as the original part. Unauthorized substitutions may result in fire, electric shock, or other hazards.
24. Upon completion of any service or repairs to this product, ask the service technician to perform safety checks to determine that the product is in proper operating condition.

**Introduction**

Now you can take advantage of traditional McIntosh standards of excellence in the MC162 power amplifier. Two 160 watt high current output channels will drive any high quality loudspeaker system to its ultimate performance. The MC162 reproduction is sonically transparent and absolutely accurate. The McIntosh Sound is "The Sound of the Music Itself."

**Performance Features**

● **Power Output**

The MC162 consists of two separate power amplifier channels, each capable of 160 watts into 4ohm speakers with less than 0.005% distortion. The two channels can be combined into a single channel with 500 watts at 4 ohms or 320 watts at 8 ohms.

● **High Current Output**

A peak output current of 25 amperes per channel ensures that the MC162 will successfully drive high quality loudspeakers such as McIntosh for a truly exciting sound experience.

● **Power Guard**

Both channels include the patented McIntosh Power Guard circuit that prevents the amplifier from being overdriven into clipping with its harsh distorted sound that can also damage your valuable loudspeakers.

● **Sentry Monitor**

McIntosh Sentry Monitor power output stage protection circuits are present on both channels to ensure the MC162 will have a long and trouble free operating life.

● **Thermal Protection**

Built-in thermal protection circuits guard against overheating which could shorten the normal long life expectancy of your McIntosh power amplifier.

● **Illuminated Power Meters**

The illuminated power output watt meters on the MC162 are peak responding, and indicate the power output of the amplifier. The Peak Hold Mode allows the meters to temporarily stay at the highest power output and then slowly decay.

**Installation**

The MC162 can be placed upright on a table or shelf, standing on its four feet. It also can be custom installed in a piece of furniture or cabinet of your choice. The required panel cutout, ventilation cutout and unit dimensions are shown.

Always provide adequate ventilation for your MC162. Cool operation ensures the longest possible operating life for any electronic instrument. Do not install the MC162 directly above a heat generating component such as a high powered amplifier. If all the components are installed in a single cabinet, a quiet running ventilation fan can be a definite asset in maintaining all the system components at the coolest possible operating temperature.

A custom cabinet installation should provide the following minimum spacing dimensions for cool operation. Allow at least 2 inches (5.1 cm) above the top and 1 inch (2.54 cm) on each side of the amplifier, so that airflow is not obstructed. 21 inches (53.3cm) depth behind the mounting panel, which includes clearance for connectors. Allow 1-1/8 inches (2.9cm) in front of the mounting panel for knob clearance. Be sure to cut out a ventilation hole in the mounting shelf according to the dimensions in the drawing.

*NOTE: In Europe, if the MC162 is custom mounted, an additional ventilation opening of 1-1/2 inch (3.8 cm) in height, running the full width of the front panel, needs to be directly above the front top of the MC162.*

Front View of the MC162 custom installed

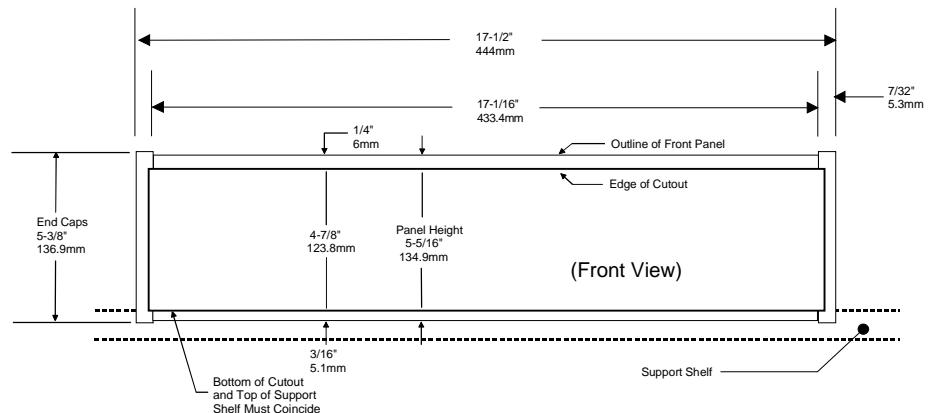

Side View of the MC162 custom installed

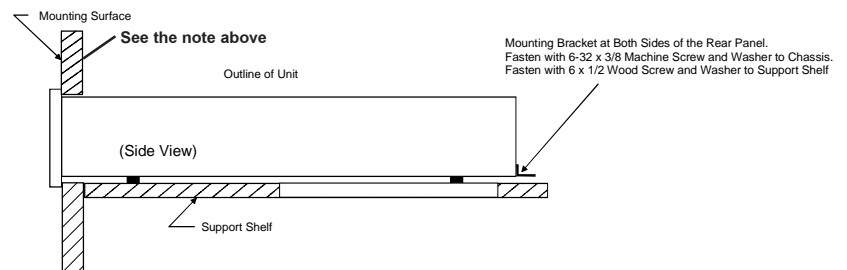

Bottom View of the MC162 custom installed

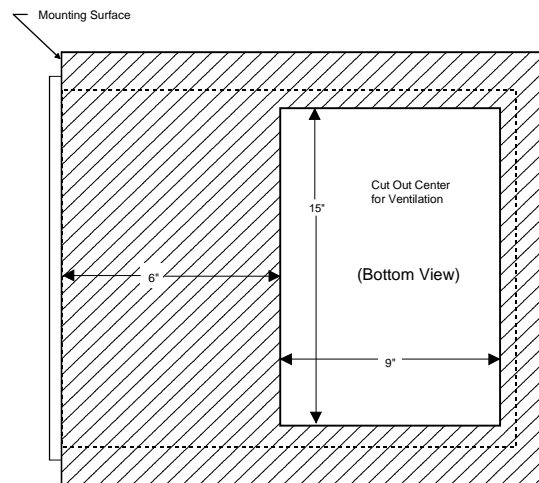



## MC162 Rear Panel Controls and Connections

Connect the MC162 power cord to a live AC outlet. Refer to information on the back panel to determine the correct voltage.

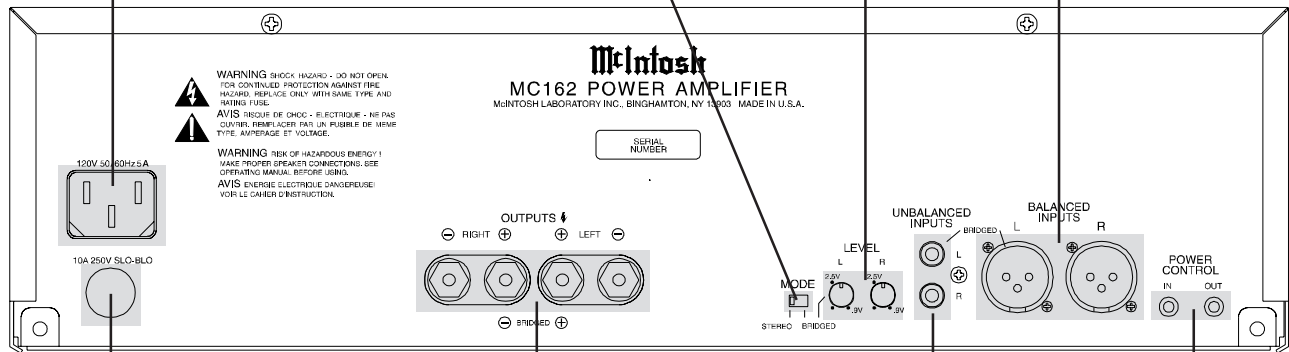

MODE switch selects different modes of operation

Input LEVEL controls for Right and Left channels

BALANCED INPUTS for audio cables from a preamplifier or control center audio outputs

OUTPUT Connections for 4 or 8 ohm loudspeakers

UNBALANCED INPUTS for audio cables from a preamplifier or control center audio output

Main Fuse holder, refer to information on the back panel of your MC162 to determine the correct fuse size and rating.

POWER CONTROL IN receives turn on/off signals from a McIntosh component and the POWER CONTROL OUT sends that turn on/off signal to the next McIntosh component.

## How to Connect the MC162

1. Connect the MC162 power cord to a live AC outlet.
2. Connect a power control cable from the control center Power Control Out to the MC162 Power Control In.
3. Connect the loudspeaker cables to the appropriate terminals for your loudspeakers, being careful to observe the correct polarities.

**NOTE:** To prevent the possibility of user contact with potentially dangerous voltages, install the protective cover(s) over the loudspeaker output terminals after the loudspeaker cables have been connected. The covers and cover mounting screws are located in an accessory package that is enclosed in the amplifier shipping carton. There are two types of

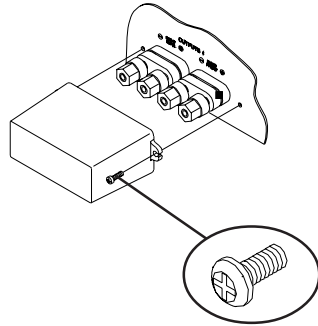

screws in the package. Install the protective covers with the Phillips, 6-32 by 5/16 inch self tapping screws. The other screws are No. 6 by 1/2 inch wood screws used to secure the amplifier custom mounting brackets to a shelf.

4. Connect a cable from the unbalanced outputs of a control center to the MC162 unbalanced Input connectors for both audio channels and power control.

Note: An optional hookup is to use balanced cables from a McIntosh Control Center to inputs of the MC162.

Pin configuration for the XLR Balanced Input connectors on the MC162:

PIN 1: Shield or ground.

PIN 2: + input.

PIN 3: - input.

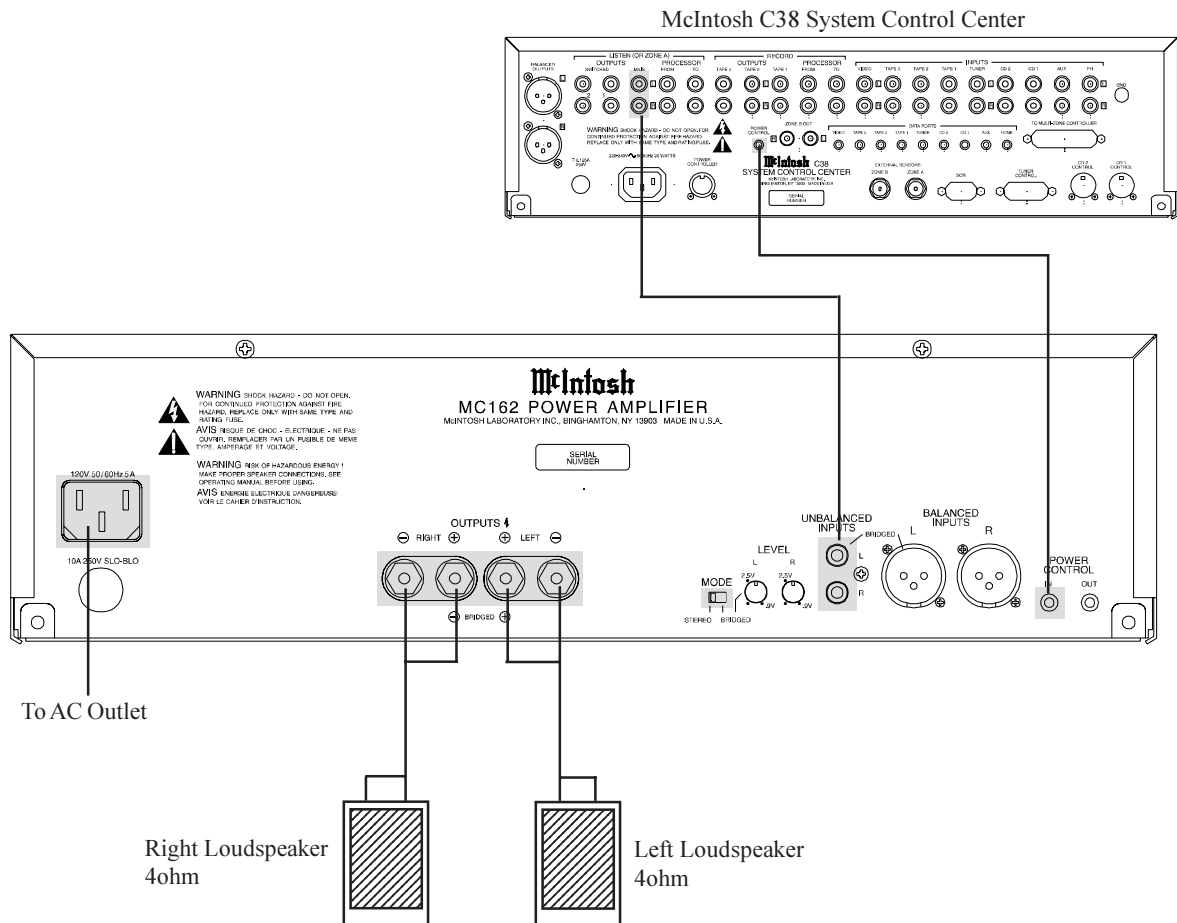



MC162 Front Panel Displays and Controls

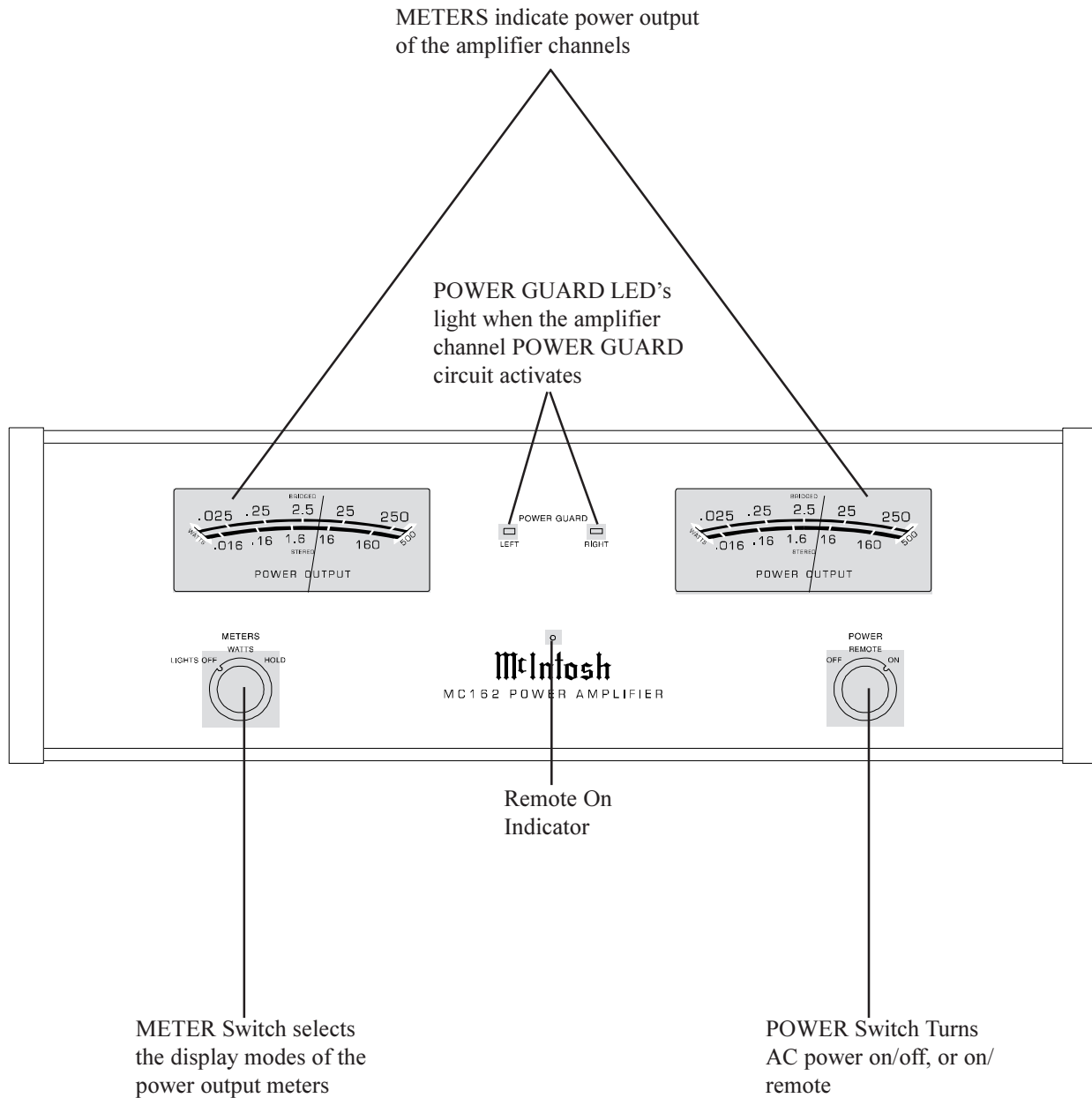



## How to Operate the MC162

### Input Level Controls

When using a McIntosh Control Center set both level controls to the 2.5V position. If a preamplifier or control center has a .9V output rating set the controls to the .9V position. If an increase or decrease in amplifier sensitivity is required for other applications, set the controls as desired. Refer to Figure 1.

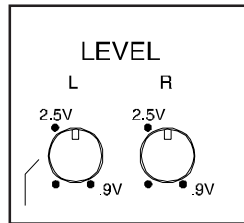

Figure 1

### Power On

To have the MC162 turn on or off when a control center turns on or off, rotate the power switch to the remote position. For manual operation, rotate the power switch to the on or off position as desired.

*Note: There must be a power control connection between the MC162 and the McIntosh Control Center in order for the remote power turn on to function.*

### Mode Switch

The Mode switch allows both MC162 channels to be used in two different operating configurations.

**Stereo:** Both channels operate independently as left and right stereo 160 watt amplifiers.

**Bridged:** Both channels operate in bridged configuration for a single monaural 500 watt amplifier.

### Meter Selection

Rotate the meter mode switch to select the meter operation mode you desire:

**Lights Off** - Meter lights are turned off, however the meters will still be operating.

**Watts** - The meters respond to all the musical information being produced by the amplifier and indicate to an accuracy of at least 95% of the power output of either amplifier channel.

**Hold** - The meter pointer is locked to the highest power peak in a sequence of peaks. The meter is electronically held to this power level until another higher power peak passes through the amplifier. The meter pointer will then rise to the newer higher indication. If no further power peaks are reached, the meter pointer will very slowly return to its rest position or lower power level.

## How to Operate the MC162 in Bridge Mode

The MC162 can be operated in Bridged Mono Mode for 500 watts into 4 ohms or 320 watts into 8 ohms. The Bridged mode outputs are floating above chassis ground. Refer to Figure 2.

1. Set the MC162 Mode switch to the Bridged position.
2. Adjust the Left Level control to the 2.5V position if using a McIntosh Preamplifier or Control Center.
3. Connect the cable from the signal source component to the Left input.
4. Connect the loudspeaker cables to the appropriate bridged terminals

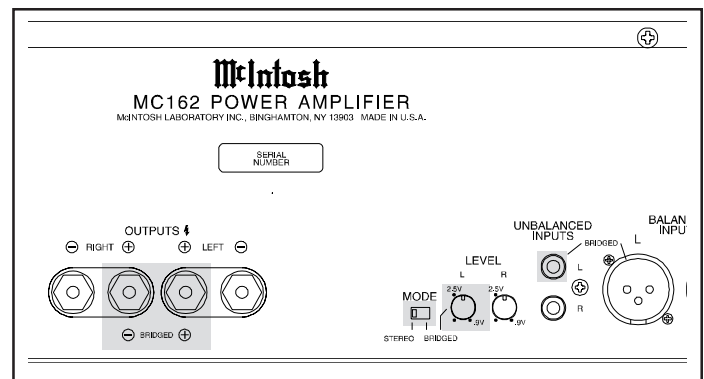

Figure 2

## How to Read the Power Output Meters

The MC162 Power Output Meter lower scales are based on using 4 ohm loudspeakers. If 8 ohm speakers are used, the actual power output is one half the power available to 4 ohm loudspeakers. The upper meter scales indicate the power output of each channel when the MC162 is connected in bridged configuration into a 4 ohm loudspeaker. Use the chart below to determine the actual power output sent to your loudspeakers.

| Lower Scale Meter Readings |                        |                        |
|----------------------------|------------------------|------------------------|
| Meter Reading              | With 4Ω Loudspeaker(s) | With 8Ω Loudspeaker(s) |
| .016                       | .016 Watts             | .008 Watts             |
| .16                        | .16 Watts              | .08 Watts              |
| 1.6                        | 1.6 Watts              | .8 Watts               |
| 16                         | 16 Watts               | 8 Watts                |
| 160                        | 160 Watts              | 80 Watts               |



### Specifications

#### Power Output Per Channel

160 watts into 4 or 100 watts into 8 ohm loads is the minimum sine wave continuous average power output per channel both channels operating.

#### Power Output Bridged

500 watts into 4 ohms or 320 watts into 8 ohm loads is the minimum sine wave continuous average power output.

#### Output Load Impedance

4 or 8 ohms

#### Rated Power Band

20Hz to 20,000Hz

#### Dynamic Headroom

1.6dB

#### Frequency Response

+0, -0.25dB from 20Hz to 20,000Hz

+0, -3dB from 10Hz to 100,000Hz

#### Total Harmonic Distortion

0.005% maximum at any power level from 250 milliwatts to rated power per channel from 20Hz to 20,000Hz, both channels operating.

#### Intermodulation Distortion

0.005% maximum if instantaneous peak output per channel does not exceed twice the rated output with both channels operating for any combination of frequencies from 20Hz to 20,000Hz.

#### Signal To Noise Ratio

110dB below rated output

#### Sensitivity

.9 volts (2.0V at level control center detent position)

#### Input Impedance

10,000 ohms Unbalanced

22,000 ohms Balanced

#### Damping Factor

Greater than 100 at 4 ohms

Greater than 200 at 8 ohms

#### Power Requirements

100 Volts, 50/60Hz at 6.0 amps

110 Volts, 50/60Hz at 5.45 amps

120 Volts, 50/60Hz at 5.0 amps

220 Volts, 50/60Hz at 2.7 amps

230 Volts, 50/60Hz at 2.6 amps

240 Volts, 50/60Hz at 2.5 amps

*NOTE: Refer to the rear panel of the MC162 for the correct voltage*

#### Dimensions

Front Panel: 17 1/2 inches (44.5cm) wide, 5-3/8 inches (13.7cm) high. Depth behind front mounting panel is 18 1/2 inches (47cm) including clearance for connectors. Panel clearance required in front of mounting panel is 1-1/8 inches (2.9cm).

#### Weight

42 pounds (19.1 Kg) net, 60 pounds (27.2 Kg) in shipping carton

## Packing Instructions

In the event it is necessary to repack the equipment for shipment, the equipment must be packed exactly as shown below. It is very important that the four plastic feet are attached to the bottom of the equipment. Three #10 x 2-1/4" screws and washers must be used to fasten the unit securely to the bottom pad and wood skid This will ensure the proper equipment location on the bottom pad. Failure to do this will result in shipping damage.

Use the original shipping carton and interior parts only if they are all in good serviceable condition. If a shipping carton or any of the interior part(s) are needed, please call or write Customer Service Department of McIntosh Laboratory. Please see the Part List for the correct part numbers.

| Quantity | Part Number | Description                                       |
|----------|-------------|---|
| 1        | 033838      | Shipping carton only                              |
| 4        | 033837      | End cap (Foam pad)                                |
| 1        | 033836      | Inside carton only                                |
| 1        | 033725      | Top Pad   |
| 1        | 034008      | Bottom pad  |
| 3        | 017218      | Plastic foot (spacer)                             |
| 1        | 033699      | Wood skid   |
| 3        | 101169      | #10 x 2-1/4" Wood screw                           |
| 3        | 104033      | #10 x 1-3/4" Wood screw                           |
| 4        | 017218      | Plastic foot                                      |
| 4        | 100159      | #10-32 x 3/4" Machine screw                       |
| 4        | 104083      | #10 x 7/16" Flat washer                           |
| 1        | 049107      | Shipping carton complete with all the above parts |

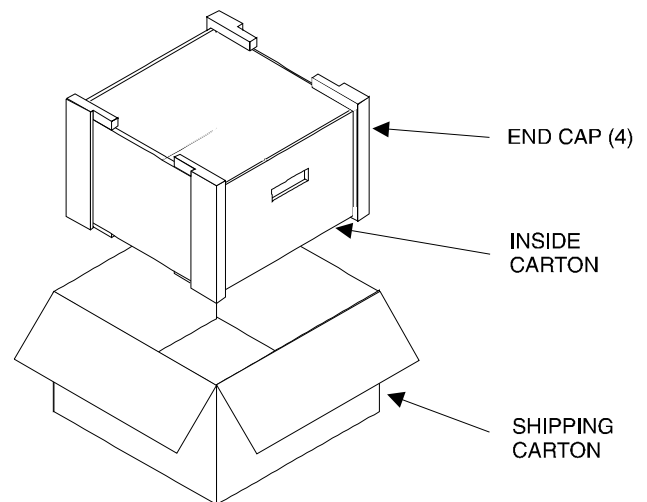
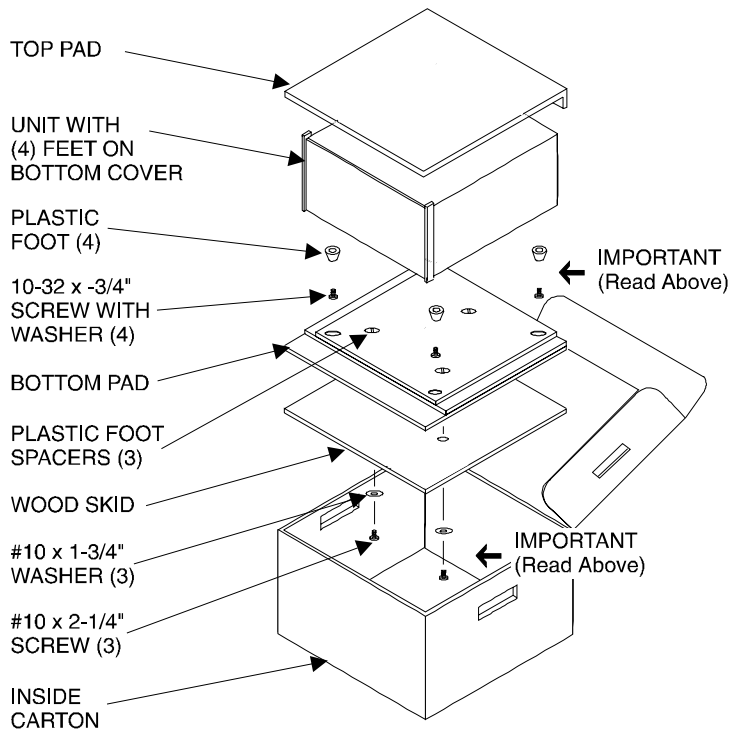

**McIntosh<sup>®</sup>**

McIntosh Laboratory, Inc.  
2 Chambers Street  
Binghamton, NY 13903