

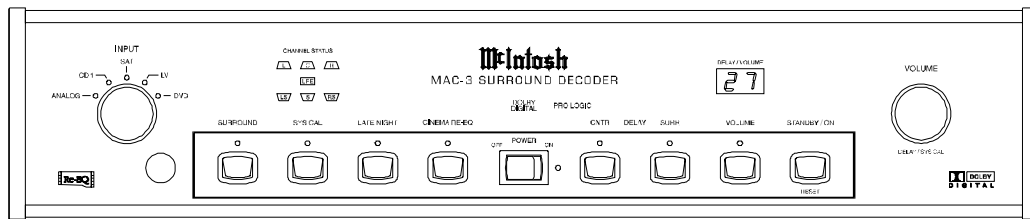

Surround Decoder, Dolby Digital® (AC-3)



MAC-3

Manufactured under license from Dolby Laboratories.
“Dolby”, “AC-3”, “Pro Logic” and the Double D symbol
are registered trademarks of Dolby Laboratories.



Thank You, Please Take A Moment, Customer Service and Table of Contents

Thank You

For your decision to own this McIntosh MAC-3 Surround Decoder ranks you at the very top among discriminating music listeners. You now have "The Best." The McIntosh dedication to "Quality," is assurance that you will receive many years of musical enjoyment from this unit.

Please take a short time to read the information in this manual. We want you to be as familiar as possible with all the features and functions of your new McIntosh MAC-3. This will ensure that you receive all the performance benefits this equipment can offer you, and that it will become a highly valued part of your home entertainment system.

Please Take A Moment

The serial number, purchase date and McIntosh dealer name are important to you for possible insurance claim or future service. The serial number is located on the rear panel of the equipment. The spaces below have been provided for you to record that information:

Serial Number:

Purchase Date:

Dealer Name:

Customer Service

If at any time you have questions about your MAC-3 Surround Decoder, please contact:

McIntosh Laboratory, Inc.
2 Chambers Street
Binghamton, New York 13903
Phone: 607-723-3512
FAX: 607-724-0549

Table of Contents

Thank You	2
Please Take a Moment	2
Customer Service	2
Table of Contents	2
Safety Instructions	3
Introduction	4
Performance Features	4
Installation	6
Rear Panel Switches and Connections	7
How to Connect with a C39/MX130	8
How to Connect in a Stand Alone System	9
Front Panel Controls, Push-Buttons, Switches and Displays	10
Delay Calibration for Center and Surround Channels	11
How to Operate with a C39/MX130	12
System Level Calibration	14
How to Operate in a Stand Alone System	15
A Place for Your Notes	17
Specifications	18
Packing Instruction	19

NOTE: The MAC-3 can be operated together with a McIntosh C39 or MX130 Control Center. It may also be operated together with a McIntosh Audio/Video Selector MVS-3 and a MC7106 Power Amplifier. There are two sets of instructions to cover both possibilities. Please refer to the following listing of instructions as a guide:

For use with a McIntosh C39 or MX130

How to Connect with a C39/MX130	8
Delay Calibration for Center and Surround Channels	11
How to Operate with a C39/MX130	12

For use with a McIntosh MVS-3 and MC7106

How to Connect in a Stand Alone System	9
Delay Calibration for Center and Surround Channels	11
System Level Calibration	14
How to Operate in a Stand Alone System	15

IMPORTANT SAFETY INSTRUCTIONS!

PLEASE READ THEM BEFORE OPERATING THIS EQUIPMENT.

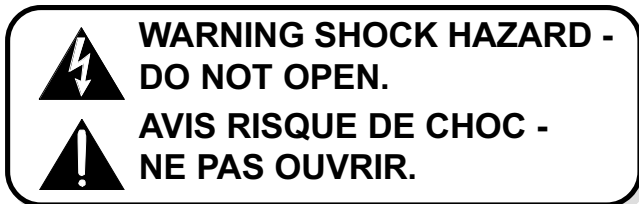

General:

1. Read all the safety and operating instructions, contained in this owner's manual, before operating this equipment.
2. Retain this owner's manual for future reference about safety and operating instructions.
3. Adhere to all warnings and operating instructions.
4. Follow all operating and use instructions.
5. **Warning: To reduce risk of fire or electrical shock, do not expose this equipment to rain or moisture. This unit is capable of producing high sound pressure levels. Continued exposure to high sound pressure levels can cause permanent hearing impairment or loss. User caution is advised and ear protection is recommended when playing at high volumes.**
6. **Caution: to prevent electrical shock do not use this (polarized) plug with an extension cord, receptacle or other outlet unless the blades can be fully inserted to prevent blade exposure.**
Attention: pour pevenir les chocs elecriques pas utiliser cette fiche polarisee avec un prolongateur, une prise de courant ou un autre sortie de courant, sauf si les lames peuvent etre inserees afond ans en laisser aucune partie a decouvert.
7. For added protection for this product during a lightning storm, or when it is left unattended and unused for long periods of time, unplug it from the wall outlet and disconnect the antenna or cable system. This will prevent

damage to the product due to lightning or power line surges.

8. Do not use attachments not recommended in this owner's manual as they may cause hazards.

Installation:

9. Locate the equipment for proper ventilation. For example, the equipment should not be placed on a bed, sofa, rug, or similar surface that may block ventilation openings; or, placed in a built-in installation, such as a bookcase or cabinet, that may impede the flow of air through the ventilation openings.
10. Locate the equipment away from heat sources such as radiators, heat registers, stoves, or other appliance (including amplifiers) that produce heat.
11. Mount the equipment in a wall or cabinet only as described in this owner's manual
12. Do not use this equipment near water; for example, near a bathtub, washbowl, kitchen sink, laundry tub, in a wet basement or near a swimming pool, etc.
13. Do not place this product on an unstable cart, stand, tripod, bracket, or table. The equipment may fall, causing serious injury to a person, and serious damage to the product.

Connection:

14. Connect this equipment only to the type of AC power source as marked on the unit.
15. Route AC power cords so that they are not likely to be walked on or pinched by items placed upon or against them, paying particular attention to cords at plugs, convenience receptacles, and the point where they exit from the instrument.
16. Do not defeat the inherent design features of the polarized plug. Non-polarized line cord adapters will defeat the safety provided by the polarized AC plug. If the plug should fail to fit, contact your electrician to replace your obsolete outlet. Do not defeat the safety purpose of the grounding-type plug.
17. Do not overload wall outlets, extension cords or integral convenience receptacles as this can result in a risk of fire or electric shock.

Care of Equipment:

18. Clean the instrument by dusting with a dry cloth. Unplug this equipment from the wall outlet and clean the panel with a cloth moistened with a window cleaner. Do not use liquid cleaners or aerosol cleaners.



19. Do not permit objects of any kind to be pushed and/or fall into the equipment through enclosure openings. Never spill liquids into the equipment through enclosure openings.
20. Unplug the power cord from the AC power outlet when left unused for a long period of time.

Repair of Equipment:

21. Unplug this equipment from the wall outlet and refer servicing to a qualified service personnel under the following conditions:
 - A. The AC power cord or the plug has been damaged,
 - B. Objects have fallen, or liquid has been spilled into the equipment,
 - C. The equipment has been exposed to rain or water,
 - D. The equipment does not operate normally by following the operating instructions contained within this owner's manual. Adjust only those controls that are covered by the operating instructions, as an improper adjustment of other controls may result in damage and will often require extensive work by a qualified technician to restore the product to its normal operation,
 - E. The equipment has been dropped or damaged in any way,
 - F. The equipment exhibits a distinct change in performance - this indicates a need for service.
22. Do not attempt to service beyond that described in the operating instructions. All other service should be referred to qualified service personnel.
23. When replacement parts are required, be sure the service technician has used replacement parts specified by McIntosh or have the same characteristics as the original part. Unauthorized substitutions may result in fire, electric shock, or other hazards.
24. Upon completion of any service or repairs to this product, ask the service technician to perform safety checks to determine that the product is in proper operating condition.

Introduction

The McIntosh MAC-3 is a precision Dolby Digital AC-3® surround decoder which will reproduce the six discrete channels of encoded sound tracks with ultimate fidelity and sonic purity. The MAC-3 also incorporates a Dolby Pro Logic® surround decoder to reproduce Dolby Surround® sound tracks with superior audio quality. The MAC-3 has many valuable and useful features that will enhance your listening experience.

Performance Features

- **Remote Controlled by a C39 or MX130**
When used with a C39 or MX130, the MAC-3 inputs can be selected by remote control.
- **Assemble a Simplified Surround Sound System**
Use an MAC-3 as a stand alone decoder with a McIntosh MVS-3 Audio/Video Selector and an MC7106 Six Channel Power Amplifier for a simplified Dolby Digital/Pro Logic Surround sound system.
- **24 Bit DSP Processing**
Two Motorola 24 Bit Digital Processors decode both Dolby Digital and Pro Logic signals. This combination is one of the most powerful processing systems available.
- **20 Bit Conversion**
Three 20 bit stereo digital to analog, (D/A) converters are used to reproduce the six decoded Dolby Digital audio channels, and one 20 bit stereo analog to digital, (A/D) converter is for signals fed into the analog inputs.
- **Digital Input Switching**
Four Digital Coaxial and matching Optical inputs are provided for four program sources:
 1. Digital Versatile Disc (DVD)
 2. Laser Video Disc Player (LV)
 3. Satellite Tuner or Receiver (SAT)
 4. CD Player (CD1)

The LV AC-3 RF INPUT receives RF signals from a Laser Video Disc Player reproducing Dolby Digital sound tracks. The ANALOG Stereo Input accept stereo signals from any audio source.

- **Automatic Mode Switching**

The MAC-3 automatically switches operating modes between Dolby Digital or Pro Logic, according to the input signal.

- **LED Channel Status Indicators**

The MAC-3 includes seven LED's on the front panel to indicate what type of operating signals are being received.

- **Adjustable Channel Time Delays**

Signals to the Center channel and Surround channels can be time delayed. This feature can be used to correct for different listening distances from the center speaker and surround speakers relative to the front speakers.

- **Precision Tracking Volume Control**

An electronic Volume Control adjusts all six channels with tracking accuracy better than 0.5dB.

- **LED Delay/Volume Indicator**

The front panel two digit LED reads Volume in percent. It also indicates time delay in milliseconds during time delay calibration, and channel level in dB during surround level calibration.

- **Built-In System Level Calibration Generator**

A built-in test signal generator can be switched manually or automatically through all system channels for surround level calibration. The levels can be adjusted plus or minus 12dB.

- **Cinema Re-Equalization**

THX® RE-EQualization filter™ compensates for the differences in room acoustics between the movie theater and a home theater room.

- **Late Night Dynamic Audio Compression**

With Dolby Digital sound tracks, a dynamic volume level compressor can be switched in to reduce the wide dynamic range of music and sound effects. This feature can be very useful for late night listening or when you have close neighbors.

- **Automatic Input Level Control**

The Analog Input includes a special circuit which protects against accidental input signal overdrive.

- **IR Remote Control**

When used in a simplified system with the MVS-3 and MC7106, the MAC-3 can be controlled directly with an optional Remote Control (HR39/HR130) through its front panel IR (Infra Red) sensor.

- **Speaker Settings for Bass Management**

The MAC-3 processing circuits allow you to change the bass cutoff frequency fed to the front, center and surround channels to 80Hz, when using a subwoofer.

- **Automatic Power On-Off**

The MAC-3 AC power can be turned on or off with a Power Control signal from a McIntosh Control Center or other McIntosh accessory component.



Installation

The MAC-3 can be placed upright on a table or shelf, standing on its four feet. It also can be custom installed in a piece of furniture or cabinet of your choice. The required panel cutout, ventilation cutout and unit dimensions are shown.

Always provide adequate ventilation for your MAC-3. Cool operation ensures the longest possible operating life for any electronic instrument. Do not install the MAC-3 directly above a heat generating component such as a high powered amplifier. If all the components are installed in a single cabinet, a quiet running ventilation fan can be a definite asset in maintaining all the system components at the coolest possible

operating temperature.

A custom cabinet installation should provide the following minimum spacing dimensions for cool operation. Allow at least 1-1/2 inches (3.8cm) above the unit so airflow is not obstructed. Allow 17-1/2 inches (44.5cm) depth behind the mounting panel, which includes clearance for connectors. Allow 1-1/8 inches (2.9cm) in front of the mounting panel for knob clearance. Be sure to cut out a ventilation hole in the mounting shelf according to the dimensions in the drawing.

Front View of a MAC-3 custom installed

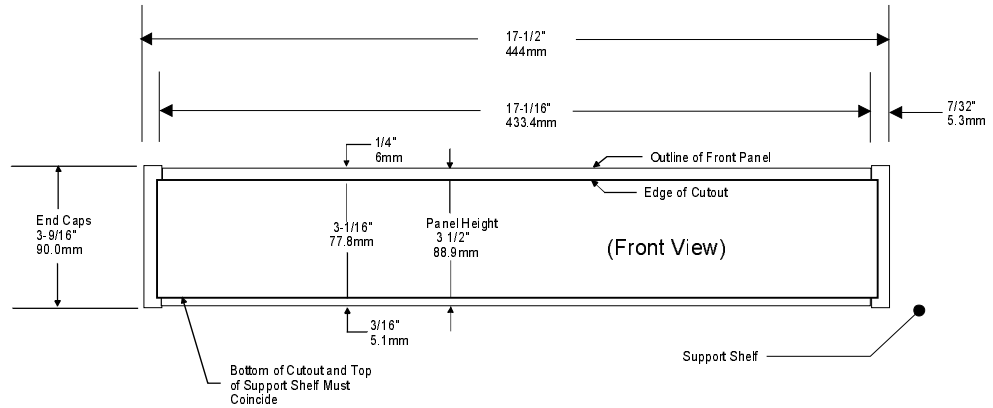

Side View of a MAC-3 custom installed

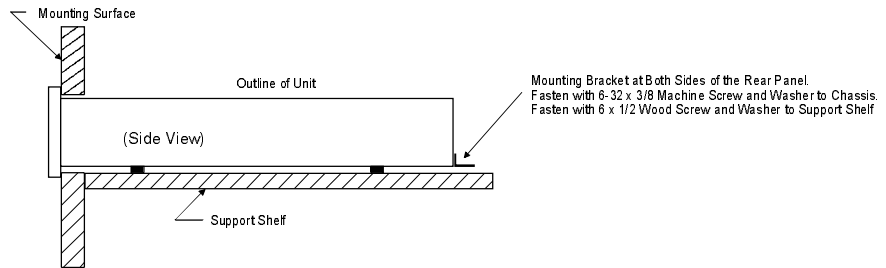

Bottom View of a MAC-3 custom installed

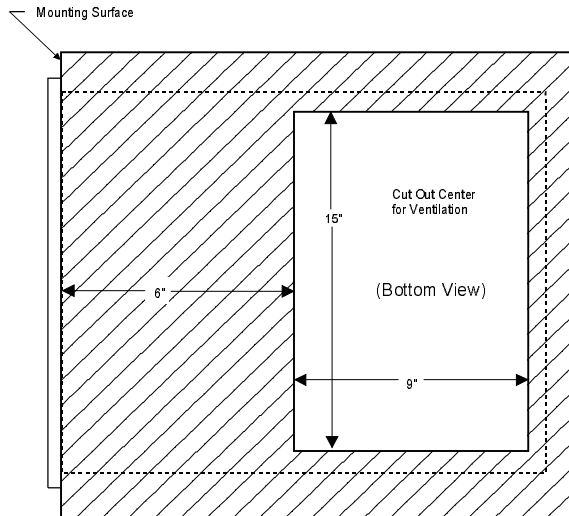

Rear Panel Switches and Connections

Connect the MAC-3 power cord to a live AC outlet. Refer to information on the back panel of your MAC-3 to determine the correct voltage for your unit.

When the MAC-3 is being used in a system with a C39 or MX130 the POWER CONTROL IN receives turn on and off signals from the McIntosh Control Center. The POWER CONTROL OUT jack sends a turn on and off signal out to a McIntosh Power Amplifier.

Set the FP SENSOR (Front Panel Sensor) slide switch to the OFF position when the MAC-3 is being used in a system with a C39 or MX130. Set the FP SENSOR slide switch to the ON position when the MAC-3 is being used as a stand alone decoder together with an MVS-3 and MC7106 in a simplified surround system.

The SPEAKER SETTINGS switches adjust the bass frequency response to the correct frequency ranges to match the sizes of the front, center and surround speakers. If any speaker in the system is classed as small, frequencies from 80Hz and lower can be switched to the subwoofer output. Set the SUBWOOF switch to ON only when a subwoofer is used in the system.

Receives signals from a stereo analog signal source.

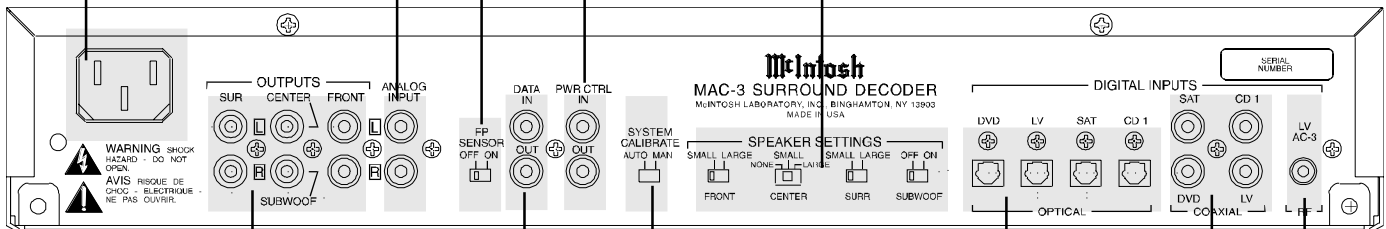

The six outputs feed audio signals to the matching inputs on a Control Center or power amplifier.
 L SUR (Left Surround)
 R SUR (Right Surround)
 CENTER (Center)
 SUBWOOF (Subwoofer)
 L FRONT (Left Front)
 R FRONT (Right Front)

The DATA IN jack receives operating signals from the SUM DATA out of a McIntosh C39 or MX130. The DATA OUT jack sends signals on to another McIntosh component.

AUTO (Automatic) switches the built-in calibration test signal generator to each of the six channels in 2 second intervals on a continuous basis. MAN (Manual) system calibration requires the manual selection of each channel.

Receives a signal from the Optical Output of a component with a digital audio output.

Receives a signal from the Coaxial Output of a component with a digital audio output.

Receives RF signal from a Video Disc Player reproducing a Dolby Digital (AC-3) sound track.



How to Connect with a C39/MX130

1. Connect the MAC-3 power cord to a live AC outlet.
2. Connect the six MAC-3 audio outputs to the six matching audio inputs on a C39 or MX130.
3. Connect the MAC-3 DATA IN jack to the C39 or MX130 SUM DATA jack.
4. Connect the MAC-3 PWR CTRL IN jack to the C39 or MX130 POWER CONTROL jack.

NOTE: A Power Control and Data cable consists of shielded wire, with 1/8" mini phone plugs on each end, either mono or stereo. Connections are to the tip and sleeve of the plugs. (McIntosh Part Number 170-202)

Connect to a Digital Signal Source

1. McIntosh MLD7020 Laser Video Disc player.
 - a. Connect the MLD7020 RF OUT to the AC-3 RF input on the MAC-3.
 - b. Connect either the MLD7020 Optical or Coaxial

Digital Output to the matching MAC-3 Digital Input.

2. DVD (Digital Versatile Disc Player)
 - a. Connect the DVD digital output, either optical or coaxial, to the MAC-3 DVD DIGITAL INPUT.
3. SAT (Satellite Receiver)
 - a. Connect the Satellite Receiver digital output, either optical or coaxial, to the MAC-3 SAT input.

NOTE: For information on Video and Analog Audio connections, refer to the owner's manual(s) for the component(s). Use either an OPTICAL or a COAXIAL INPUT from a digital component, but not both for the same component

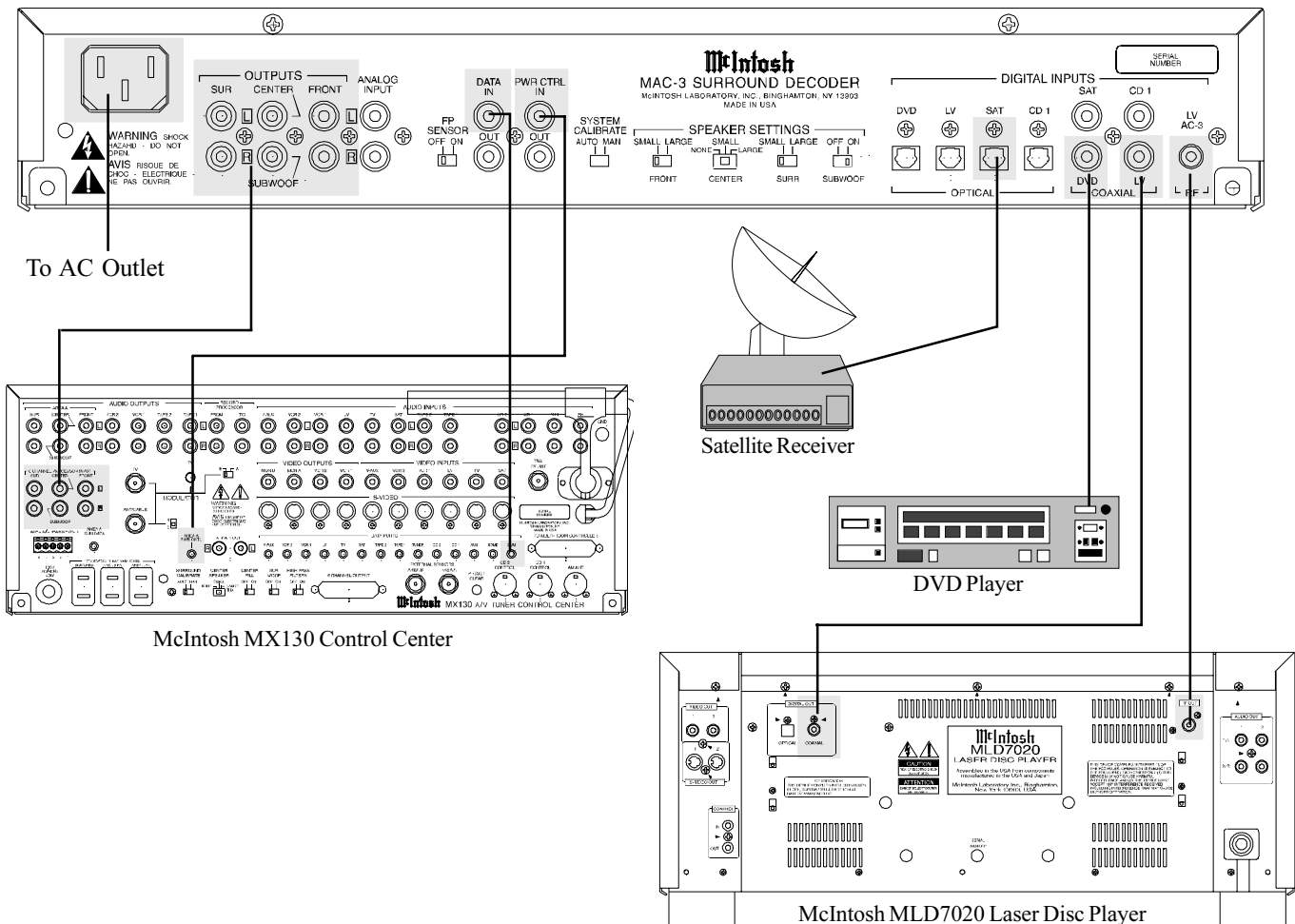

How to Connect in a Stand Alone System

1. Connect the MAC-3 power cord to a live AC outlet.
2. Connect the six MAC-3 Audio Outputs to the matching channel inputs on the MC7106 amplifier.
3. Connect the MAC-3 PWR CTRL OUT to the MC7106 POWER CONTROL IN.
4. Connect the MAC-3 DATA OUT to the MVS-3 DATA IN jack.
5. Connect the MVS-3 CONTROL CENTER AUDIO OUTPUTS to the MAC-3 ANALOG INPUT.

NOTE: A Power Control and Data cable consists of shielded wire, with 1/8" mini phone plugs on each end, either mono or stereo. Connections are to the tip and sleeve of the plugs. (McIntosh Part Number 170-202)

Connect to a Digital Signal Source

1. McIntosh MLD7020 Laser Video Disc player.

- a. Connect the MLD7020 RF OUT to the AC-3 RF input on the MAC-3.
- b. Connect either the MLD7020 Optical or Coaxial Digital Output to the matching MAC-3 Digital Input.

2. DVD (Digital Versatile Disc Player)

- a. Connect the DVD digital output, either optical or coaxial, to the MAC-3 DVD DIGITAL INPUT.

3. SAT (Satellite Receiver)

- a. Connect the Satellite Receiver digital output, either optical or coaxial, to the MAC-3 SAT input.

NOTE: For information on Video and Analog Audio connections, refer to the owner's manual(s) for the component(s). Use either an OPTICAL or a COAXIAL INPUT from a digital component, but not both for the same component

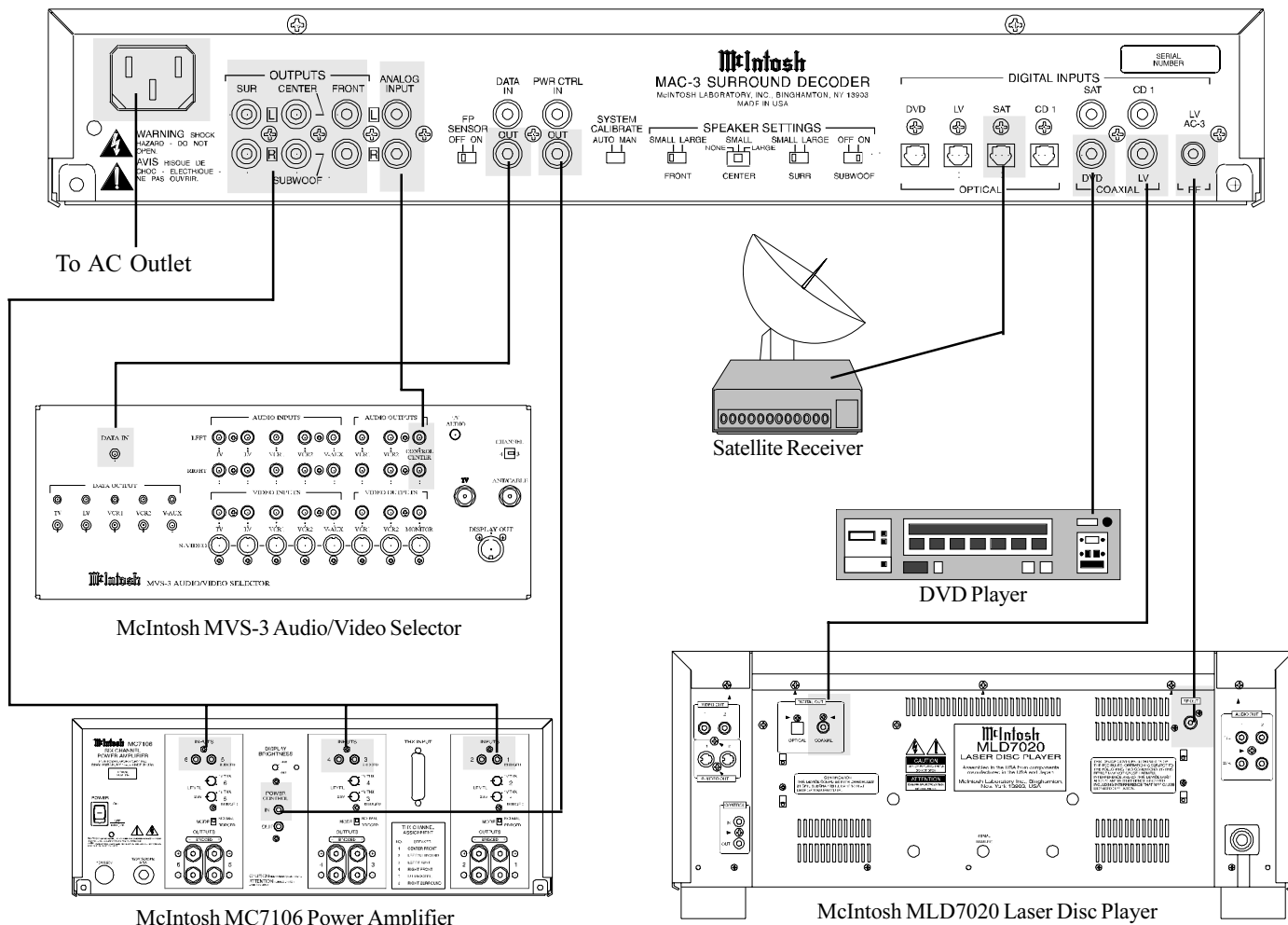



Front Panel Controls, Push-Buttons, Switches and Displays

Front Panel Controls, Push-Buttons, Switches and Displays

The INPUT switch selects any one of the four DIGITAL INPUTS or the ANALOG INPUT.

The CHANNEL STATUS LED display indicates which channels are active, depending on the incoming signal; L (Left Front), C (Center), R (Right Front), LFE (Low Frequency Effects), LS (Left Surround), S (Pro Logic Surround), R (Right Surround)

The IR (Infra Red) sensor accepts IR signals directly from an HR39/HR130 Remote Control.

The appropriate nomenclature turns on to indicate which Dolby mode is active.

The DELAY/VOLUME display indicates three types of information; Volume Level, System Calibration, and Time Delay.

The STANDBY/ON push-button turns the MAC-3 on and off, and can reset all the MAC-3 microprocessors.

The VOLUME control is used for four different operations; level match, volume level, channel time delay and system level calibration.

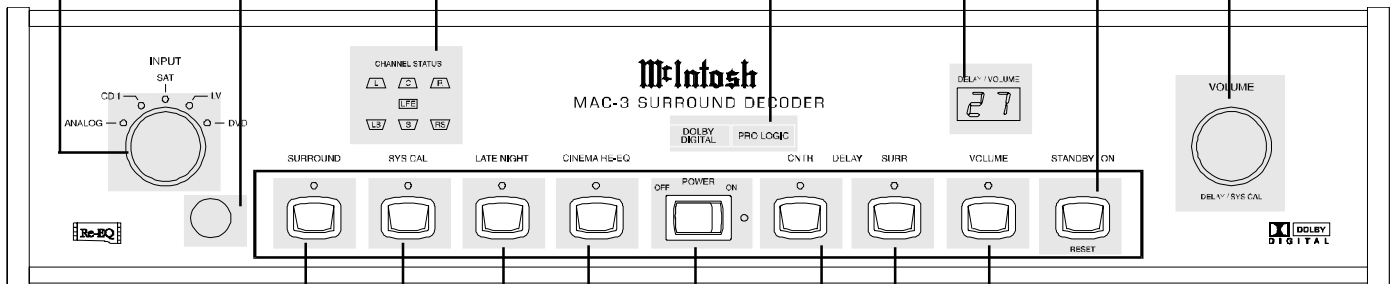

The SURROUND push-button switches between internal Dolby Surround Decoding and Stereo

The POWER switch turns all power completely ON or OFF.

The VOLUME push-button activates the various volume control functions.

Press the SYS CAL, (System Calibration) push-button to activate the internal test signal generator for surround channel level calibration.

The Cinema RE-EQ push-button activates the THX® RE-Equalization filter™, which compensates for the differences in room acoustics between the movie theater and a home theater room.

Press the Surr (SURROUND) push-button to temporarily activate the surround channel time delay adjusting process

The LATE NIGHT push-button turns the volume compression circuit ON and OFF.

Press the CNTR (Center) DELAY push-button to temporarily activate the center channel time delay adjusting process.

Delay Calibration for Center and Surround Channels

Delay and Level calibration procedures are made relative to the listening area. The ideal listening area is defined as facing directly toward and centered between the front speakers, and in line with the left and right surround speakers.

NOTE: Refer to the Front Panel Drawing on the opposite page and Figures 1 & 2 on this page for the following steps.

Center Speaker Delay

If the center speaker is located closer to the listening area than the left and right front speakers, its sound will reach the listener before the sound from the left and right front speakers. This difference in sound arrival times can degrade the listening perception of some sound tracks. The MAC-3 allows you to adjust the center speaker time delay to correct for this difference so the sound from the center speaker reaches the listening area at the same time as sound from the front left and right speakers.

NOTE: The MAC-3 center delay can be adjusted from 0 to 5ms. Each millisecond delay corresponds approximately to 1 foot in distance.

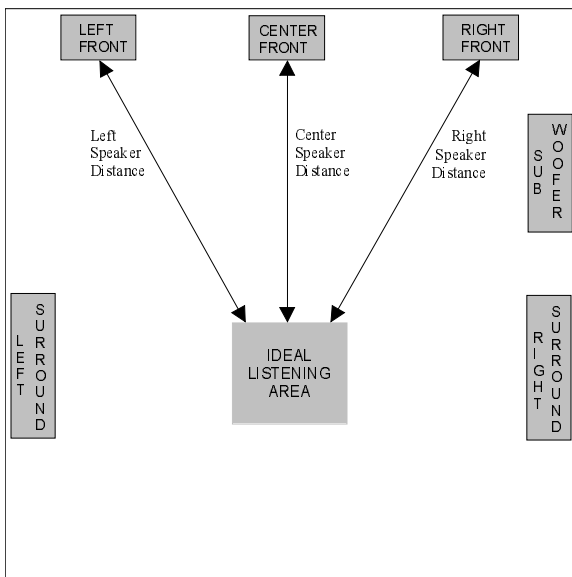

Figure 1

The first time you press the CNTR/DELAY push-button, the DELAY/VOLUME display will indicate 0ms, which is the factory default setting equivalent to no delay. This corresponds to a listening room where the center speaker is the same distance from the listening area as the front left and right speakers. If your center speaker is closer to the listening area than the front left and right speakers, adjust the de-

lay to correspond to the difference in feet.

1. Measure the distance from the listening area to the center speaker and then the front left and right speakers. If the center speaker is the same distance as the front speakers, no calibration is necessary since the default factory setting is 0ms. If the center speaker is closer than the front speakers you should adjust the delay to correspond to the difference in feet.
2. Press the CNTR/DELAY push-button to start delay calibration procedure.
3. Adjust the VOLUME control until the DELAY/VOLUME display reads a number equivalent to how many feet closer the center speaker is to the listening area.
4. Press the CNTR/DELAY push-button a second time to exit the delay procedure.

Surround Speaker Delay

If the surround speakers are located closer to the listening area than the front speakers, their sound will reach the listener before the sound from the front speakers. This difference in sound arrival times can degrade the listening perception of some sound tracks. The MAC-3 allows you to adjust the surround speaker time delay to correct for this difference so the sound from the surround speakers reaches the listening area at the same time as sound from the front left and right speakers.

NOTE: The MAC-3 surround delay can be adjusted from 0 to 15ms. Each millisecond delay corresponds approximately to 1 foot in distance.

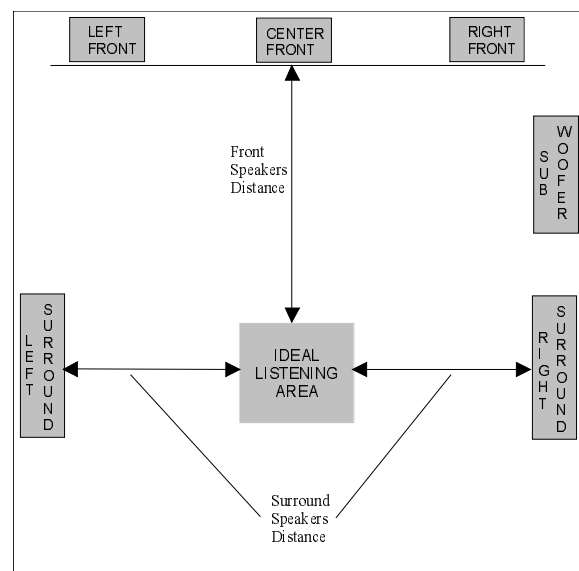

Figure 2



The first time you press the SURR/DELAY push-button the DELAY/VOLUME display will indicate 5, which is equivalent to a 5 millisecond delay which is the factory default setting. This would correspond to a typical listening room where the surround speakers are 5 feet closer to the listening area than the front speakers. If your surround speakers are in a different location, adjust the delay to correspond to their distances from the listening area relative to the front speakers.

1. Measure the distance from the listening area to the surround speakers, and then to the front left and right speakers. If the surround speakers are the same distance as the front speakers, the calibration delay should be set to 0ms. If the surround speakers are closer than the front speakers you should adjust the delay to correspond to the difference in feet.
2. Press the SURR/DELAY push-button to start delay calibration procedure.
3. Adjust the VOLUME control until the DELAY/VOLUME display reads a number that is the same as the number of feet measured in Step 1.
4. Press the SURR/DELAY push-button a second time to exit the delay procedure.

EXAMPLE: If your center speaker is 2 feet closer to the listening area than the front speakers, set the center delay to "2". If your surround speakers are 4 feet closer to the listening area than the front speakers, set the surround delay to "4".

NOTE: The following table may be used to record your Delay Calibration Settings.

Delay Calibration	Default Setting	New Setting
Center Channel	0	
Surround Channels	5	

How to Operate with a C39/MX130

The following information assumes the MAC-3 is being used in a system together with a digital signal source such as a McIntosh MLD7020 Laser Video Disc player, a DVD player or a Satellite Receiver. The MAC-3 is operated by an HR39/HR130 Remote Control sending IR signals to the Control Center sensor.

Selecting inputs with the Remote Control results in the MAC-3 input selection automatically tracking with the Control Center input. If Inputs are selected manually by

turning the C39 or MX130 LISTEN switch, the matching MAC-3 inputs must also be selected manually by the MAC-3 INPUT switch.

The DVD input on the MAC-3 is the same as the V-AUX input on the Control Center. If any input other than the four MAC-3 inputs are selected, the MAC-3 will default to the Analog input.

NOTE: If your C39 or MX130 has the THX-M module installed, switch the Control Center back to internal processing CINEMA 2 to take advantage of the THX® enhancements to the Dolby Pro Logic decoded sound tracks.

FP Sensor

Set the FP SENSOR switch to OFF.

NOTE: This prevents the MAC-3's built-in sensor from receiving the remote control commands that have been already received directly from the C39 or MX130, thus causing improper functioning. Refer to Figure 3.

Late Night

The LATE NIGHT push-button turns a volume compression circuit on and off. This feature suppresses loud sounds or music that might disturb neighbors or others not in the immediate area of the home theater. Soft levels are also raised slightly so they are still listenable at reduced overall volume levels. This works only on a Dolby Digital sound tracks with encoded data that supports the compression function.

Equalization Filter

THX® RE-Equalization filter™ adjusts the frequency response for movie listening.

Channel Status LED's

If the signal source contains a Dolby Digital sound track, the MAC-3 switches to Dolby Digital mode. The front panel CHANNEL STATUS LED's L, C, R, LFE, LS and RS will turn on in accordance to the channels that are present on the Dolby Digital sound track.

If the signal source contains only a Dolby Pro Logic sound track, the MAC-3 switches to Pro Logic mode. The front panel CHANNEL STATUS LED's L, R, and S will turn on.

Volume Control

The MAC-3 VOLUME control is factory preset with the volume display indicating 75. This is the recommended ini-

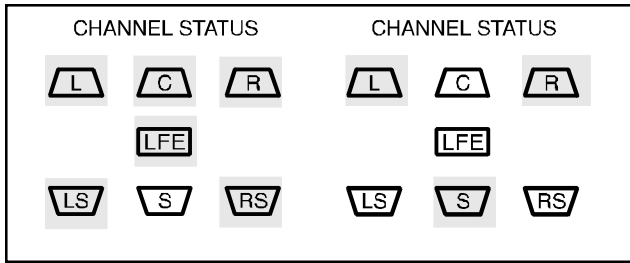

Dolby Digital Signal Dolby Pro Logic Signal

tial volume calibration when the MAC-3 is used in a system with a C39 or MX130. If you wish to change the audio volume level from signal sources connected to the MAC-3 relative to other signal sources selected by the C39 or MX130, press the VOLUME push-button to activate the MAC-3 volume control. Adjust the control until the desired level is reached. Press the VOLUME push-button again to deactivate the volume control. This will prevent an accidental change of the calibrated level

NOTE: If the input selector is set to (CD 1, SAT, LV or DVD) and no digital signal is present, the Volume push-button LED will flash on/off to indicate the outputs are muted. When the outputs are muted the volume control calibrated level will not function as described above.

Front Speakers (Small-Large)

When the front left and right speakers cover the full frequency range down to 20Hz, set the switch to LARGE.

When the front speakers cover the frequency range only down to 80Hz, set the switch to SMALL. A built-in electronic crossover will remove frequencies of 80Hz and lower from the front left and right speakers and redirect them to the Subwoofer speaker.

Center Speaker (None-Small-Large)

When the center speaker covers the full frequency range down to 20Hz, set the switch to LARGE.

When the Center speaker covers the frequency range only down to 80Hz, set the switch to SMALL. A built-in electronic crossover will remove frequencies of 80Hz and lower from the Center speaker and redirect them to the Subwoofer speaker.

When there is no center speaker in the system, set the switch to NONE. The Center channel signal is sent to the

left and right front speakers. This mode of operation results in the listeners perceiving a “Phantom” center speaker.

Surround Speakers (Small-Large)

When the surround speakers cover the full frequency range down to 20Hz, set the switch to LARGE.

When the surround speakers cover the frequency range only down to 80Hz, set the switch to SMALL. The built-in electronic crossover will remove frequencies of 80Hz and lower from the surround speakers and redirect them to the subwoofer speaker.

Subwoofer Speaker (Off-On)

Set the SUBWOOF switch to ON whenever a subwoofer is used in the system. In this mode, the LFE (Low Frequency Effects) are always sent to the subwoofer. The subwoofer also receives from any channel(s), that have their SPEAKER switches set to SMALL, low frequencies of 80Hz and lower.

Set SUBWOOF switch to OFF when all SPEAKER switches are set to LARGE and no subwoofer is being used in the system. The LFE (Low Frequency Effects) signals

are sent equally to each of the five remaining channels. If the SUBWOOF switch is OFF and there are no large full range speakers in the system, you will not hear the extreme low frequencies. When no subwoofer is connected and LARGE (Full Range) Loudspeakers are connected the Front Left

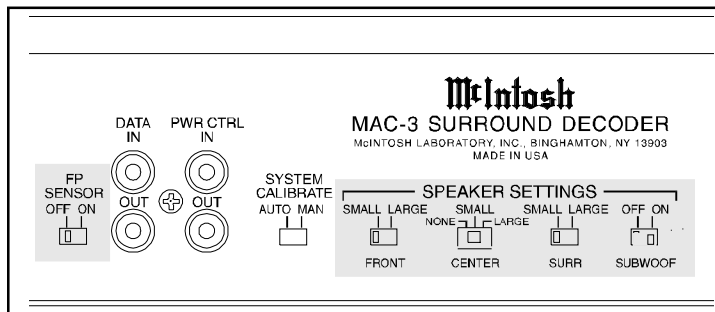

Figure 3

and Right Channels, the LFE (Low Frequency Effects) are directed to them.

EXAMPLE: If you are using McIntosh speakers, HT-1 or SL-6, HT-2 or SL-1, HT-3, HT-4, use the following settings.

Set FRONT to SMALL.

Set CENTER to SMALL.

Set SURR to SMALL

Set SUBWOOF to ON.

Reset of Microprocessors

In the event that the controls of the MAC-3 stop functioning, there is a user reset function built in. While the MAC-3 is on depress and hold in the STANDBY/ON/RESET push button for five seconds, this will reset the MAC-3's microprocessors.

NOTE: The above condition is usually caused by either interruptions in AC power and/or major changes in voltage.



System Level Calibration

The MAC-3 includes a built-in test signal generator to perform System Level Calibration. A properly calibrated surround sound system should have all channel levels adjusted initially for similar volume in the listening area. This ensures that multi channel sound tracks will be reproduced with optimum realism. Individual channel levels from an actual sound track usually change widely on a continuous basis. Proper System Calibration sets all channels to the correct starting reference level.

NOTE: When the MAC-3 is used in a system with the C39 or MX130, it is recommended that level calibration be done at the A/V Control Center. Refer to the Control Center Owner's Manual for details.

The built-in calibration should be used primarily when the MAC-3 is used in a stand alone system. When in the System Calibration mode, it is most convenient to make level adjustments from the listening area with the optional HR39/HR130 Remote Control. The MAC-3 VOLUME control can also be used to adjust levels. A sound level pressure meter may be used to obtain a more accurate calibration. Refer to Figures 4 and 5 for the followings steps.

Automatic System Calibration

1. Set the rear panel SYSTEM CALIBRATION switch to AUTO.
2. Adjust the MAC-3 volume control until the display reads 70. This is an initial reference setting to ensure that the test signals will be adequately loud to perform the level calibration.
3. Press the SYS CAL push-button once to start System Calibration. You will hear the test signal from the left front speaker for 2 seconds. The test signal will then cycle through all six channels continuously in 2 second intervals, clockwise starting with Left Front, Center, Right Front, Right Surround, Left Surround and Subwoofer. The MAC-3 DELAY/VOLUME display will read "0" for each channel before any adjustments are performed.

NOTE: The front panel CHANNEL STATUS LED's will light to indicate which channel is reproducing the test signal.

4. While seated in the listening area, note the volume levels of the test signal from each of the channels as the test signal switches. If you determine that the test signal volume is louder or softer in any of the channels, the levels should be adjusted so you hear essentially the same test signal volume from all of the channels. The left front channel volume level can serve as a reference.
5. Make channel level calibration adjustments with the optional HR39/HR130 Remote Control Surround Up and Down push-buttons from the listening area. You can also use the MAC-3 volume control. If an adjustment is made on a channel, there is an additional 2 second time interval on that channel before the system switches the test signal to the next channel. As a level is changed, the DELAY/VOLUME display instantly changes to indicate the calibration level change in dB. If the level is increased, the display shows plus numbers, and if decreased shows minus numbers. Calibration levels can be adjusted over a range of plus or minus 12dB.
6. When the test signal switches to succeeding channels, repeat the level calibration process until the test signal volume levels of all the channels are the same.
7. The calibration channel cycling mode can be repeated as often as necessary until you are satisfied that the volume levels of the test signal are the same from all channels.

8. Exit the System Calibration mode by pressing the SYS CAL push-button a second time.

NOTE: All System Level Calibrations are retained in permanent memory and will change only if calibration is performed again. The factory default setting for the volume control is 75.

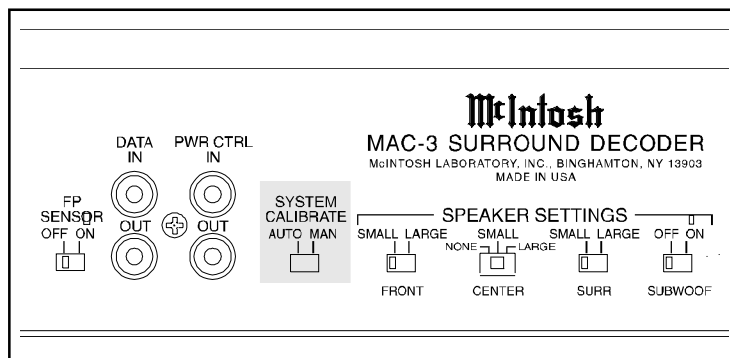

Figure 4

Manual System Calibration

1. Set the rear panel SYSTEM CALIBRATE switch to MAN.
2. Adjust the MAC-3 volume control until the display reads 70. This is an initial reference setting to ensure that the test signals will be adequately loud to perform the level calibration.
3. Press the SYS CAL push-button once to start Manual System Calibration. The first time the SYS CAL push-button is pressed, the test signal will switch to the Left

Front channel and will stay in that channel until the SYS CAL push-button is pressed again, followed by the Center, Right Front, Right Surround, Left Surround and Subwoofer. The MAC-3 DELAY/VOLUME display will read “0” for each channel before any adjustments are performed.

NOTE: The front panel CHANNEL STATUS LED's will light to indicate which channel is reproducing the test signal. A more convenient method of manually switching the test signal is to use the SP push-button on the optional HR39/HR130 Remote Control which performs the same functions as the SYS CAL push-button.

4. While seated in the listening area, note the volume levels of the test signal from each of the channels. If you determine that the test signal volume is louder or softer in any of the channels, the levels should be adjusted so you hear essentially the same test signal volume from all of the channels. The left front

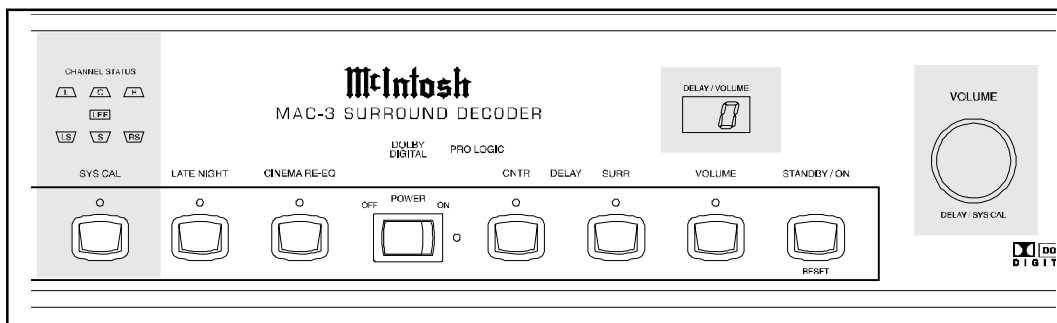

Late Night

The LATE NIGHT push-button turns a volume compression circuit on and off. This feature suppresses loud sounds or music that might

5. Exit the Manual System Calibration mode by pressing the SYS CAL push-button after calibrating the Subwoofer channel.

NOTE: All System Level Calibrations are retained in permanent memory and will change only if calibration is performed again. The following table may be used to record your Delay Calibrations Settings.

Calibration Channel	Default Setting	New Setting
Left Front	0	
Center Front	0	
Right Front	0	
Right Surround	0	
Left Surround	0	
Subwoofer	0	

How to Operate in a Stand Alone System

The following information assumes the MAC-3 is being used with a McIntosh MC7106 amplifier, MVS-3 Audio/Video Selector and a digital signal source such as McIntosh MLD7020 Laser Video Disc Player, a DVD Player or a Satellite Receiver. The MAC-3 can be operated manually or with an optional HR39/HR130 Remote Control.

FP Sensor

Set the FP SENSOR switch to ON.

NOTE: This will activate the MAC-3's built in sensor for receiving the remote control commands from the optional HR39/HR130 remote control.

Refer to Figure 6 on the next page, for location of Rear Panel Switches.

disturb neighbors or others not in the immediate area of the home theater. Soft levels are also raised slightly so they are still listenable at reduced overall volume levels. This works only on a Dolby Digital sound tracks with encoded data that supports the compression function.

Equalization Filter

THX® RE-Equalization filter™ adjusts the frequency response for movie listening.

Channel Status LED's

If the signal source contains a Dolby Digital sound track, the MAC-3 switches to Dolby Digital mode. The front panel CHANNEL STATUS LED's L, C, R, LFE, LS and RS will turn on in accordance to the channels that are present on the Dolby Digital sound track.

If the signal source contains only a Dolby Pro Logic sound track, the MAC-3 switches to Pro Logic mode. The front panel CHANNEL STATUS LED's L, R, and S will turn on.



How to Operate in a Stand Alone System con't

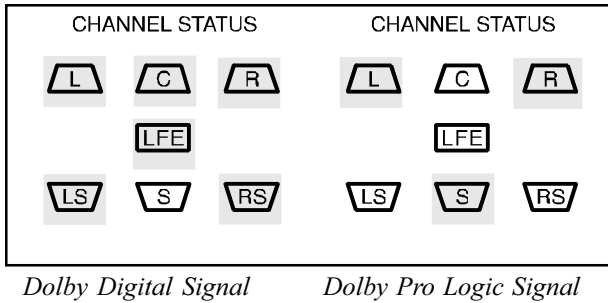

SPEAKER switches are set to LARGE and no subwoofer is being used in the system. The LFE (Low Frequency Effects) signals are sent equally to each of the five remaining channels. If the SUBWOOF switch is OFF and there are no large full range speakers in the system, you will not hear the extreme low frequencies. When no subwoofer is connected and LARGE (Full Range) Loudspeakers are connected the Front Left and Right Channels, the LFE (Low Frequency Effects) are directed to them.

EXAMPLE: If you are using McIntosh speakers, HT-1 or SL-6, HT-2 or SL-1, HT-3, HT-4, use the following settings.

- Set FRONT to SMALL.
- Set CENTER to SMALL.
- Set SURR to SMALL
- Set SUBWOOF to ON.

Front Speakers (Small-Large)

When the front left and right speakers cover the full frequency range down to 20Hz, set the switch to LARGE.

When the front speakers cover the frequency range only down to 80Hz, set the switch to SMALL. A built-in electronic crossover will remove frequencies of 80Hz and lower from the front left and right speakers and redirect them to the Subwoofer speaker.

Center Speaker (None-Small-Large)

When the center speaker covers the full frequency range down to 20Hz, set the switch to LARGE.

When the Center speaker covers the frequency range only down to 80Hz, set the switch to SMALL. A built-in electronic crossover will remove frequencies of 80Hz and lower from the Center speaker and redirect them to the Subwoofer speaker.

When there is no center speaker in the system, set the switch to NONE. The Center channel signal is sent to the left and right front speakers. This mode of operation results in the listeners perceiving a "Phantom" center speaker.

Surround Speakers (Small-Large)

When the surround speakers cover the full frequency range down to 20Hz, set the switch to LARGE.

When the surround speakers cover the frequency range only down to 80Hz, set the switch to SMALL. The built-in electronic crossover will remove frequencies of 80Hz and lower from the surround speakers and redirect them to the subwoofer speaker.

Subwoofer Speaker (Off-On)

Set the SUBWOOF switch to ON whenever a subwoofer is used in the system. In this mode, the LFE (Low Frequency Effects) are always sent to the subwoofer. The subwoofer also receives from any channel(s), that have their SPEAKER switches set to SMALL, low frequencies of 80Hz and lower.

Set SUBWOOF switch to OFF when all

Volume Control

Set the VOLUME control to the desired level.

NOTE: If the input selector is set to (CD 1, SAT, LV or DVD) and no digital signal is present, the Volume push-button LED will flash on/off to indicate the outputs are muted.

Remote Adjustment of Surround Levels

You can adjust surround levels while listening by using the Surround Up and Down push-buttons on the optional HR39/HR130 Remote Control. These adjustments will stay as long as the MAC-3 is turned on, but will be erased when the MAC-3 is turned off.

Reset of Microprocessors

In the event that the controls of the MAC-3 stop functioning, there is a user reset function built in. While the MAC-3 is on depress and hold in the STANDBY/ON/RESET push button for five seconds, this will reset the MAC-3's microprocessors.

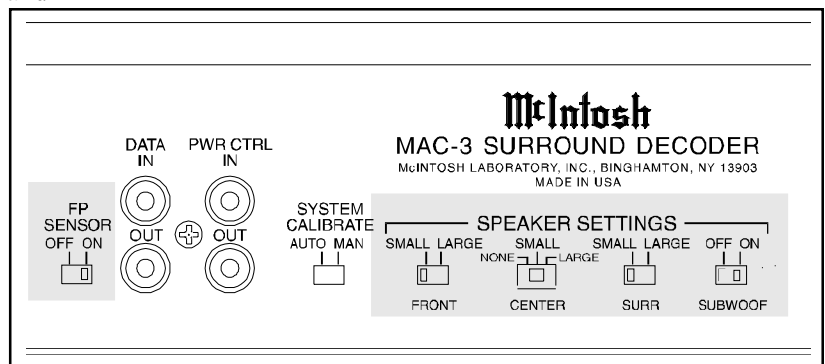

Figure 6

NOTE: The above condition is usually caused by either interruptions in AC power and/or major changes in voltage.

A Place for Your Notes



Specifications

Frequency Response

STEREO Left and Right Small speakers:
80Hz-20,000Hz.
Subwoofer:
20Hz-80Hz.

Left and Right Large speakers:
20Hz-20,000Hz.
Subwoofer:
OFF.

PRO LOGIC Left, Center, Right, Small speakers:
80Hz-20,000Hz.
Surround Small speakers:
80Hz-7kHz.
Subwoofer:
20Hz-80Hz.

Left, Center, Right, Large speakers:
20Hz-20,000Hz.
Surround Large speakers:
20Hz-7kHz.
Subwoofer:
OFF.

Dolby Digital Left, Center Right Small speakers:
80Hz-20,000Hz.
Surround Small speakers:
80Hz-20,000Hz
Subwoofer:
20Hz-80Hz.

Left, Center, Right Large speakers:
20Hz-20,000Hz
Surround Large speakers:
20Hz-20,000Hz.
Subwoofer:
OFF.

Rated Output

All Modes: 2.0VRMS for full bit.

Output Impedance

420 ohms at all outputs.

Maximum Output Voltage

8VRMS.

Total Harmonic Distortion

0.005% at all outputs.

Sensitivity

Analog Input: 500mV for 2.0V output, (100mV IHF).

Signal To Noise Ratio - All Outputs

Greater than 90dB un-weighted.
Greater than 100dB A weighted.
Greater than 98dB CCIR.

Maximum Input Signal

Analog Input: 2VRMS full BIT, 2.6VRMS with AILC.

Voltage Gain

Analog Input to Output: 12dB.

Power Requirements

100 Volts, 50/60Hz at 45 watts.
110 Volts, 50/60Hz at 45 watts.
120 Volts, 50/60Hz at 45 watts.
220 Volts, 50/60Hz at 45 watts.
230 Volts, 50/60Hz at 45 watts.
240 Volts, 50/60Hz at 45 watts.

NOTE: Refer to the rear panel of the MAC-3 for the correct voltage

Dimensions

Front Panel: 17-1/2 inches (44.5cm) Wide, 3-9/16" (9cm) High
Depth required behind mounting panel, including connectors: 17-1/2" (44.5cm).
Knob clearance required in front of mounting panel: 1-3/8" (3.5cm).

Packing Instructions

In the event it is necessary to repack the equipment for shipment, the equipment must be packed exactly as shown below. It is very important that the four plastic feet are attached to the bottom of the equipment. This will ensure the proper equipment location on the bottom pad. Failure to do this will result in shipping damage.

Use the original shipping carton and interior parts only if they are all in good serviceable condition. If a shipping carton or any of the interior part(s) are needed, please call or write Customer Service Department of McIntosh Laboratory. Please see the Part List for the correct part numbers.

Quantity	Part Number	Description
1	033770	Shipping carton only
2	033771	Cushion Pad
4	033772	Corner Pad
1	033606	Inside carton only
1	033726	Top pad
1	033729	Bottom pad
4	017218	Plastic foot
4	100159	#10-32 x 3/4" screw
4	104080	#10 Flat washer
1	048082	Shipping carton complete with all the above parts

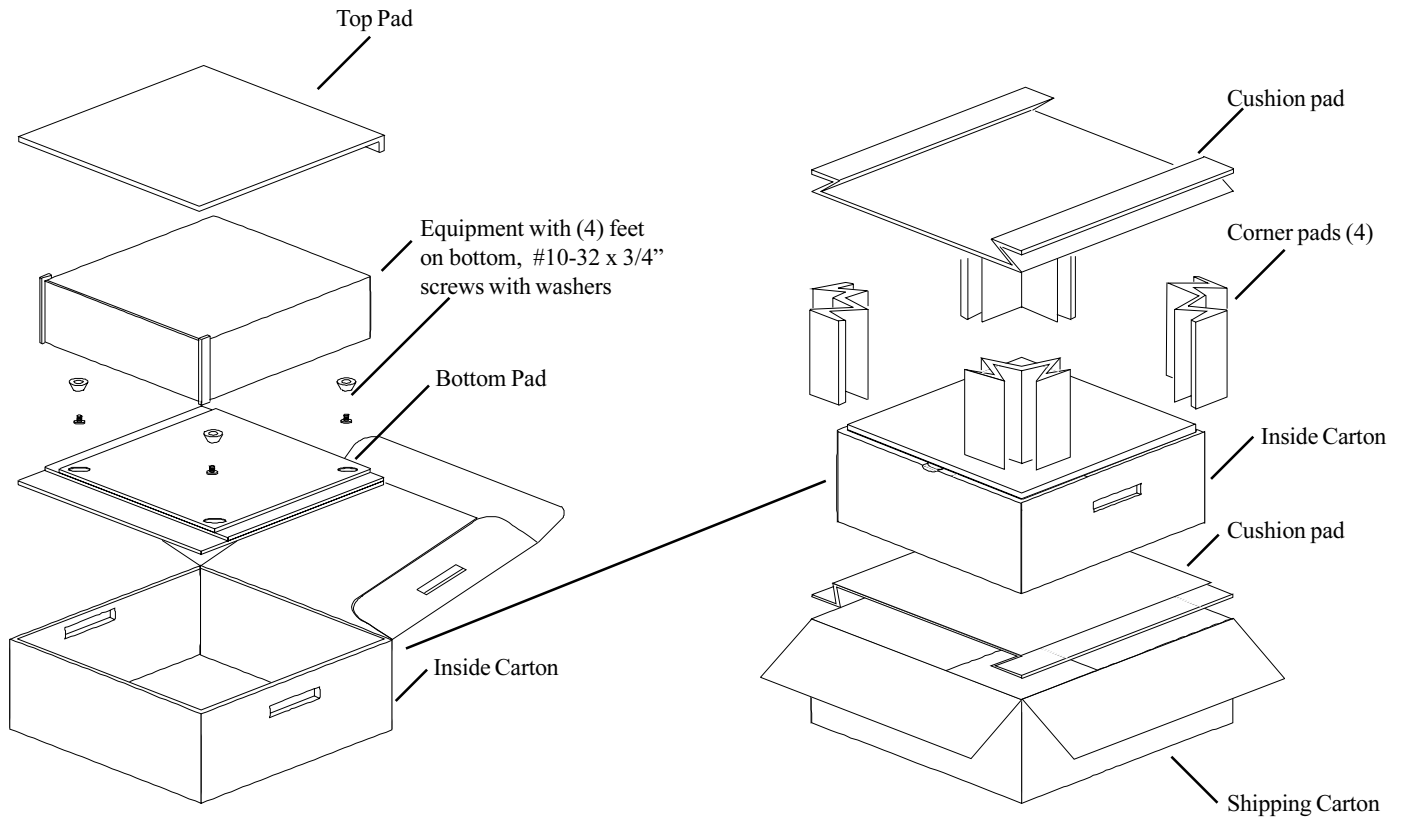

McIntosh[®]

McIntosh Laboratory, Inc.
2 Chambers Street
Binghamton, NY 13903

McIntosh Part No. 04049101