

dbx

BX-2

POWER AMPLIFIER

OWNER'S MANUAL

Congratulations upon your purchase of the dbx BX-2 Power Amplifier. Your new amplifier is completely unique in design and execution, as well as unsurpassed in overall sonic performance and power output capability. Incorporating four independent power amps, the BX-2 functions as a stereo amplifier, a 3 channel amplifier, or a 4 channel amplifier, and up to four pairs of speaker systems can be driven at a time. Prior to use, we recommend that you read this manual once through carefully to understand the features and capabilities of your BX-2 Power Amplifier.

WARNING

**TO PREVENT FIRE OR SHOCK HAZARD,
DO NOT EXPOSE THIS COMPONENT
TO RAIN OR MOISTURE.**

This triangle, which appears on your component, alerts you to the presence of uninsulated dangerous voltage inside the enclosure—voltage that may be sufficient to constitute a risk of shock.



This triangle also appears on your component, and it alerts you to important operating and maintenance instructions in this accompanying literature.

CAUTION
To Reduce Further the Risk of Shock, Do Not Remove the Cover or Back. There Are No User-Serviceable Parts Inside; Refer All Servicing to Qualified Personnel.

WARRANTY and FACTORY SERVICE

All dbx products are covered by a limited warranty (warranties for products purchased outside the USA are valid only in the country of purchase and the USA). For details, consult your warranty/registration card or your dealer/distributor.

The dbx Customer Service Dept. will help you use your new product. For answers to questions and information beyond what's in this manual, write to:

dbx
71 Chapel St.
Newton, Mass. 02195 USA
Attn: Customer Service

You also may call (617) 964-3210 during business hours (USA Eastern time). The Telex is 92-2522.

Should problems arise, consult your dealer or distributor. If it becomes necessary to have your equipment serviced at the factory, repack the unit, including a note with a description of the problem and the date of purchase, and send the unit freight prepaid to the above address, marking it Attn: Repairs.

"dbx" is a registered trademark of dbx, Newton, Mass. USA,
a division of BSR NA Ltd.



LOCATION AND FUNCTION OF CONTROLS

FRONT PANEL

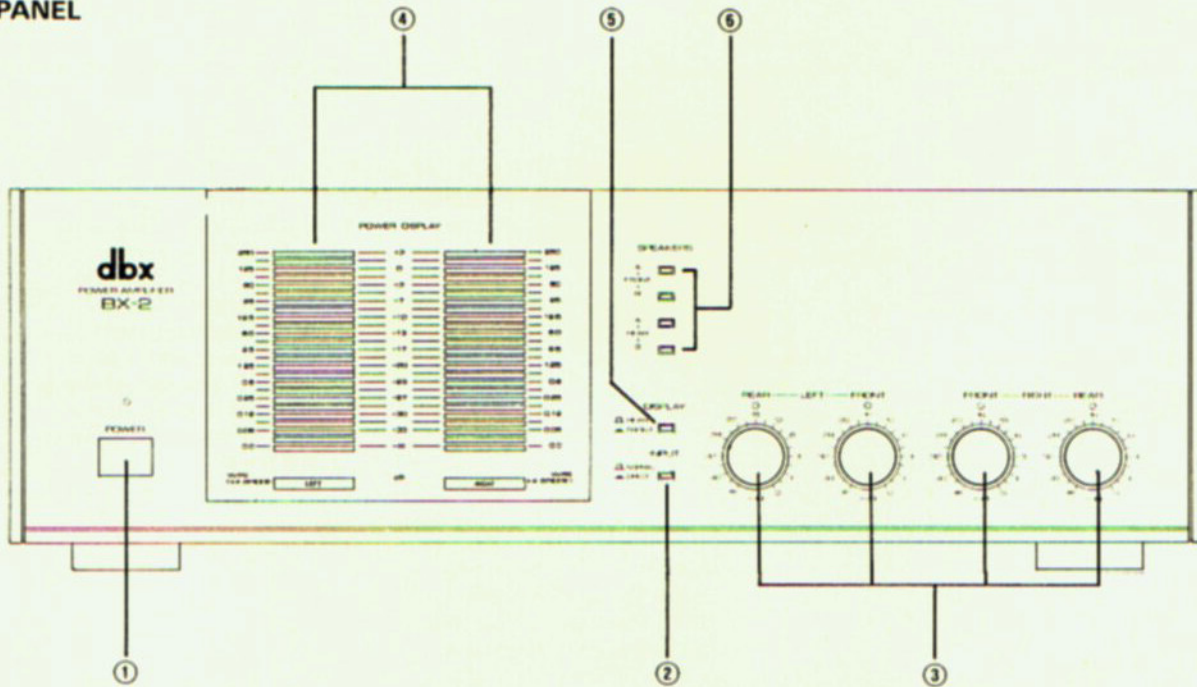

REAR PANEL

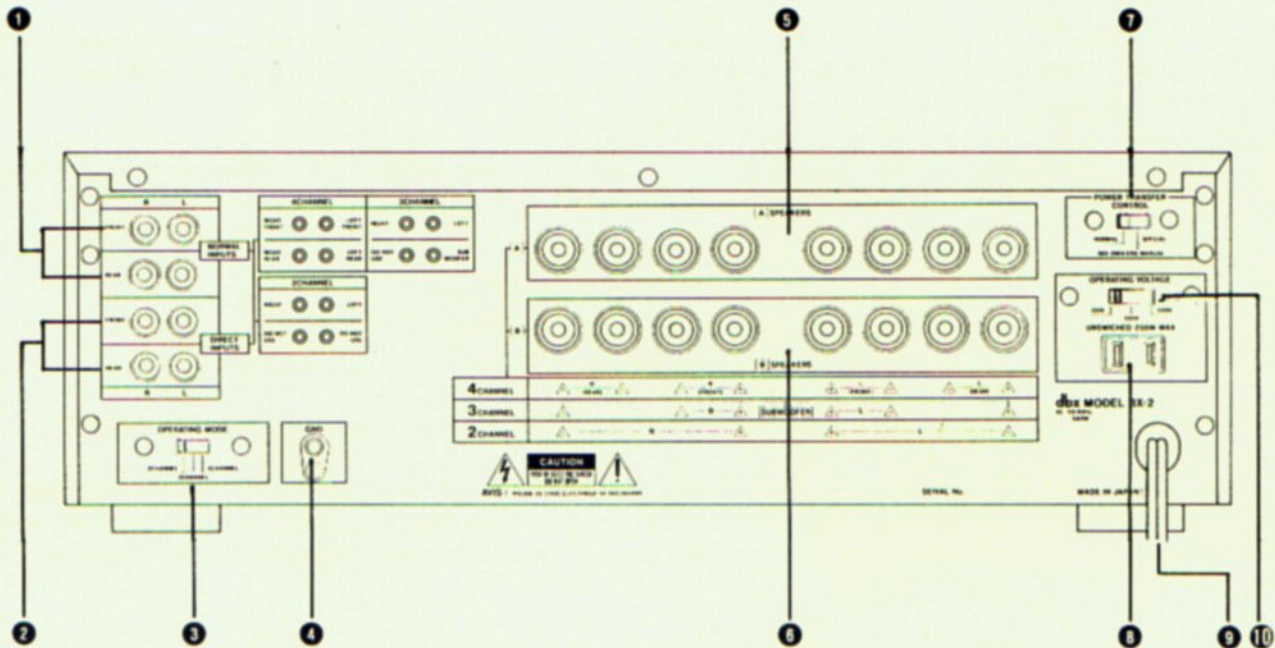

PRECAUTIONS BEFORE USE

• POWER REQUIREMENT

Power requirements for electrical equipment differ from area to area. Ensure that your amplifier meets the power requirements in your area.

120V, 60Hz for U.S.A .
220V, 50Hz for Europe except U.K .
240V, 50Hz for U.K. and Australia.

If the voltage specified in the voltage selector on the rear panel does not conform to the voltage available in your area, change the setting of the voltage selector as follows.

Using a screwdriver, remove the screws holding the cover to the rear panel, and move the selector to the correct position. After changing the setting, replace the cover with the screws.

NOTE: Be sure to disconnect the power cord when changing the setting.

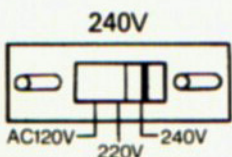
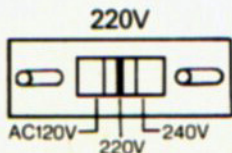
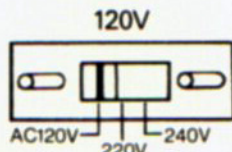

• POWER PLUG

When disconnecting the power cable from the power outlet, be sure to take hold the plug, not the wire. Never handle the power plug with wet hands since you may receive an electric shock. When you do not intend to use the amplifier for a prolonged period of time, keep the power plug disconnected from the power outlet.

• VENTILATION HOLES

The BX-2 has the ventilation holes both on the top and the underside to prevent increase of temperature inside the unit. Do not block the ventilation holes with objects over them. Avoid also installing the unit in the area with poor ventilation.

Do not put the other component such as a tuner or a pre-amplifier directly upon the BX-2 since this may result in not only blocking the ventilation holes but also causing hum or malfunction.

• INSTALLATION

Do not install the unit in the area exposed to direct sunlight, dust, dirt, moisture or humidity. Installation in the location which is susceptible to vibration should be also avoided since this may result in a deterioration in performance or malfunction.

• INSIDE THE UNIT

If a hairpin, coin or any other metal object finds its way inside the unit or if water is splashed over the unit, disconnect the power plug from the power outlet immediately and notify your nearest dealer. Continued use may cause trouble or an electric shock.

• NO USER-ADJUSTABLE PARTS INSIDE

Never check nor adjust the parts inside the unit since this may result in trouble or an electric shock. Guarantee will be invalid for malfunction or performance deterioration due to the alteration, modification or substitution other than specified.

FRONT PANEL CONTROLS AND FUNCTIONS

① POWER Switch

Pressing this switch causes the AC power to be supplied to the unit. The red LED above the switch will flash until the voltage of each circuit of the unit is stabilized, and then will become steadily illuminated.

② INPUT NORMAL/DIRECT — Input Selector

Selects the input signals between the input signal from the NORMAL INPUTS Terminals and the input signal from the DIRECT INPUTS Terminals, provided respectively on the rear panel.

Note that the Input Volume Controls are activated only when the unit is used in the NORMAL mode, and that they are disabled in the DIRECT mode.

③ Input Volume Controls

For use in adjusting the incoming signal level. The input level will increase by turning the Input Volume clockwise, and will decrease by turning it counter clockwise.

The figure below shows the channel controlled by each Input Volume in each mode.

Channel to be controlled in each mode

Input Volume Mode	LEFT/REAR	LEFT/FRONT	RIGHT/FRONT	RIGHT/REAR
4CH MODE	Left/Rear	Left/Front	Right/Front	Right/Rear
3CH MODE	CH.3	Left/Front	Right/Front	—
2CH MODE	—	Left	Right	—

④ POWER DISPLAY

These meters illuminate to indicate the output level to the speaker systems. It can indicate the peak power of either front speakers or rear speakers in 4CH mode, and the selection is made by the POWER DISPLAY Switching Button (⑤). For further details about metering in each mode, refer to Section 'CONNECTIONS AND OPERATIONS'.

NOTE: When in 2 CHANNEL mode, the indicated values are 1/4 of the actual peak power. So multiply the indicated value on either meter by four to know the actual peak power.

⑤ DISPLAY REAR, FRONT — POWER DISPLAY Switching Button

Setting this button to the FRONT position causes the POWER DISPLAY to indicate the output volume to the FRONT speaker systems in 4CH mode.

Setting this button to the REAR position causes the POWER DISPLAY to indicate the output volume to the REAR speaker systems in 4CH mode.

For metering in 2 CHANNEL mode or 3 CHANNEL mode, refer to the description given in Section 'CONNECTION AND OPERATION'.

NOTE: When the POWER DISPLAY are set to the REAR position to indicate the peak power level of third channel in 3 CHANNEL mode, move of the POWER DISPLAY becomes completely the same for both channels since the third channel is in mono-bridged connection.

⑥ SPEAKERS — Speaker System Selector Switches

Two speaker systems, System A and System B, can be connected to the BX-2 for all modes. These switches choose the System to be used.

Press the FRONT A or B, REAR A or B button in accordance with the speaker terminals to which the speaker system is connected.

REAR PANEL CONTROLS AND CONNECTORS

1 NORMAL INPUTS — Input connectors

For use in connecting output of the control amplifier. The input signal put into these connectors comes through the Input Volume Controls circuitries. When the unit is used through these terminals, set the INPUT NORMAL/DIRECT Switch (Front Panel ②) to the NORMAL position.

The upper pair is for the FRONT R, L inputs and the lower pair is for the REAR R, L inputs in 4 CHANNEL mode (or in Dual 2CH mode). In 3 CHANNEL mode, FRONT R, L and REAR L connectors are used, and only the FRONT inputs are used in 2 CHANNEL mode.

2 DIRECT INPUTS — Input connectors

For use in connecting output of the control amplifier. The input signal put into these connectors comes straight, with the Input Volume Controls circuitries bypassed.

When the unit is used through these terminals, set the INPUT NORMAL/DIRECT Switch (Front Panel ②) to the DIRECT position.

The upper pair is for the FRONT R, L inputs and the lower pair is for the REAR R, L inputs in 4 CHANNEL mode (or in Dual 2CH mode). In 3 CHANNEL mode, FRONT R, L and REAR L connectors are used, and only the FRONT inputs are used in 2 CHANNEL mode.

3 OPERATING MODE Selector — 2 CHANNEL, 3 CHANNEL, 4 CHANNEL

This switch selects the operating mode of the BX-2. Set the switch to the correct position as follows.

- When driving front speakers together with rear speakers for 4 channel surround application, or in Dual 2 channel mode, set the switch to 4 CHANNEL position.
- When driving the speakers in 3 channel mode, i.e. 2 channel plus 1 channel in mono-bridged (BTL) connection for a subwoofer, set the switch to 3 CHANNEL position.
- When driving the speakers in 2 channel mono-bridged connection, set the switch to 2 CHANNEL position.

For further informations about the relation between the connection and switch position, refer to Section 'CONNECTION AND OPERATION'.

NOTE: In changing the switch setting, be sure to turn the power off. Never change the setting while the unit is operating.

4 GND (Ground) Terminal

Used when the grounding connection is required.

5 A SPEAKERS — Speaker terminals for System A

These upper four pairs of connectors are for FRONT R, L and REAR R, L of speaker System A.

Speaker connections will be different according to the output modes. Refer to Section 'CONNECTION AND OPERATION' for further informations about speaker connections.

6 B SPEAKERS — Speaker terminals for System B

These lower four pairs of connectors are for FRONT R, L and REAR R, L of speaker System A.

Speaker connections will be different according to the output modes. Refer to Section 'CONNECTION AND OPERATION' for further informations about speaker connections.

7 POWER TRANSFER CONTROL Switch

This selector should be set according to the rated impedance of the speaker systems in use. However, consulting the operating manual of your speakers, set the selector to the proper position:

- NORMAL position: Set the POWER TRANSFER CONTROL Switch to this position for driving most speaker systems in any amplifier configuration.
- SPECIAL position: Set the POWER TRANSFER CONTROL Switch to this position for driving speaker higher than 8 ohms, or higher than 16 ohms when A and B systems are driven simultaneously, when the amplifier configuration is at 4 CHANNEL mode to allow maximum power transfer to speakers.

About speaker impedances

- 1 When the four amplifiers in BX-2 are operated independently, i.e., each amplifier output in 4 CHANNEL mode, and, L and R outputs in 3 CHANNEL mode, minimum impedance of each speaker has to be kept higher than 2 ohms. For driving A and B systems simultaneously, minimum impedance of each speaker has to be higher than 4 ohms.
- 2 When the amplifiers in BX-2 are bridged, i.e., each amplifier output in 2 CHANNEL mode, and SUBWOOFER output in 3 CHANNEL mode, speaker of higher than 4 ohms are recommended. For driving A and B systems simultaneously in these modes, speakers of higher than 8 ohms are recommended.

8 UNSWITCHED — AC power outlet

On condition that the power cord is connected to an AC wall outlet, the AC power can be supplied to other audio component connected to this outlet, regardless of switching ON/OFF of the POWER button on the front panel. Never connect the component of which power requirement exceeds 250W.

9 AC Power Cord

Connect this cord to the 120V 60Hz AC mains.

10 OPERATING VOLTAGE selector

This is for selecting the power supply voltage. Although it is set at the factory to the voltage of your region, confirm that this selector is set to the proper position prior to connecting the power to the unit.

- Cooling Fan (internal)
High level, long time operation of the unit may cause the internal chasis temperatures to be increased. With the internal temperatures over 70°C, this Cooling Fan will be operated automatically to dissipate the heat from the unit and to maintain long term operational reliability. Since it operates very quietly, music reproduction will never be disturbed.

CONNECTION AND OPERATION

CONNECTION PRECAUTIONS

- **Connection of Speaker cables**
First Strain tightly the speaker cable conductors. Loosen the cap of the speaker terminal to be connected, insert the stranded cable end as shown in the Figure below, and then tighten the post to secure the cable end.

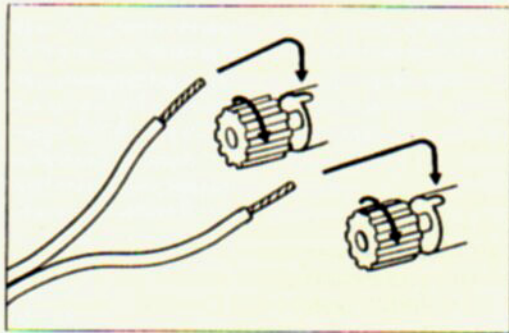

- Each time you connect the cables, be sure to connect properly, checking the right and left channel (L to L and R to R). Also remember that the '+' terminals of the speakers must be connected to '+' terminal of the amplifier, and the '-' terminals on the speakers to the '-' terminals of the amplifier.

NOTE: In 2 CHANNEL and 3 CHANNEL mode, connections will become little more complicated. For further details of these two mode, read the corresponding instructions in this section.

- When connecting, either disconnect the power plug from the power outlet or turn off the power switch.
- Check to see if the POWER TRANSFER CONTROL Switch is set properly. If it is set improperly, not only full output is not achieved but also abnormal heat may be produced.
- When both speaker System A and B are used simultaneously, be very certain that the total of the speaker impedance is not under 2 ohms in 4 CHANNEL mode or 4 ohms in 2 and 3 CHANNEL mode.

I 2 CHANNEL MODE CONNECTION

The BX-2 incorporates four monaural power amplifiers, and they can be configured into 2 channel stereo amplifier by binding four output stages into two pairs to drive 2 channel stereo speaker system. In this connection which is called bridged connection, each channel shall be driven with more than double power output for more powerful, energetic sound reproduction.

- 1) According to the 2 CHANNEL connecting indication printed on the rear panel of the unit, connect the speaker cables using the A SPEAKER terminals. Also refer to the illustration below.

NOTE: The INPUTS connectors to be used for this connection are FRONT L and R. This means that L (FRONT) and L (REAR) output stages are combined to drive FRONT L speaker, and R (FRONT) and R (REAR) output stages are combined to drive FRONT R speaker.

- 2) Set the OPERATING MODE Selector to 2 CHANNEL position. LED indicators on LEFT/FRONT and RIGHT/FRONT volume controls on the front panel (③) will be illuminated.

- 3) Press the Speaker System Selector FRONT A and REAR A (front panel ⑥).

NOTE: In this connection, POWER DISPLAY Switching function on the front panel is deactivated, and the move of the Meters will be completely the same in either position of POWER DISPLAY Switching button. Multiply the indicated value on either meter by four to know the actual peak power.

When driving another speakers, use the B speaker terminals for System B, and connect the cables referring to step 1). Be sure to set up both System A and B in the same connection mode.

To drive System B, press the Speaker System Selector FRONT B and REAR B (front panel ⑥).

To drive both systems simultaneously, press all the Speaker System Selector switches.

WARNING

Although the sound will be emitted from the speakers with the OPERATING MODE Selector set to 2 CHANNEL position, this will cause malfunction of the internal protection circuitry. Be sure to set the OPERATING MODE Selector to 2 CHANNEL position in 2 CHANNEL bridged mode.

When using an external speaker system selector unit, use of the unit which switches polarity '-' only should be avoided, since it will damage the amplifiers in 2 CHANNEL operation. Use the unit which can switch both polarities ('+' and '-').

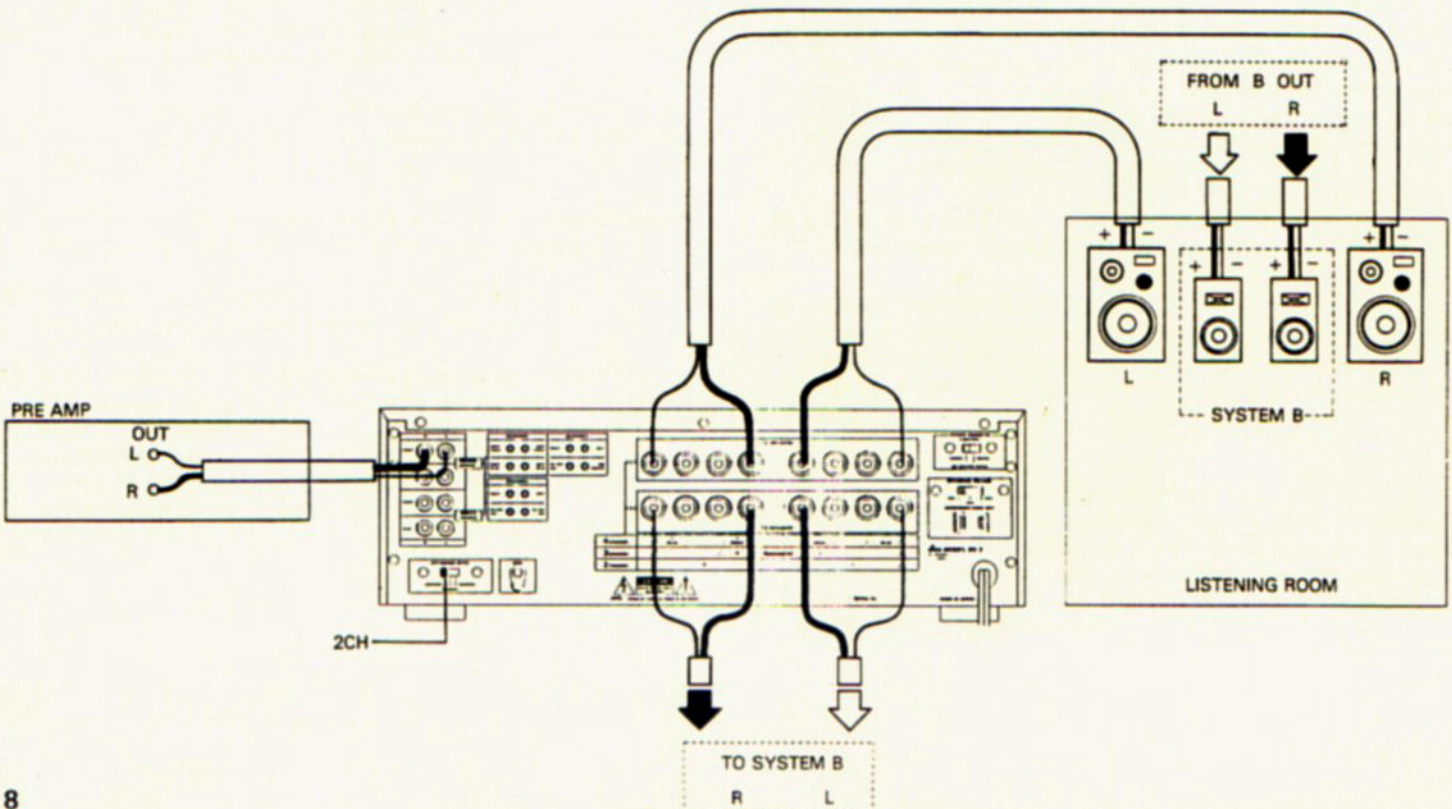

II 3 CHANNEL MODE CONNECTION

The BX-2 incorporates four monaural power amplifiers, and they can be configured into 2 channel plus mono-bridged amplifiers to drive 3 channel (2 channel stereo plus one subwoofer) speaker system, by performing connections as follows.

- 1) To set up the 2 channel stereo speaker system, connect the speaker cables as shown in the illustration below.
- 2) To drive a CH. 3 subwoofer in the mono-bridged connection, connect the speaker cables as shown in the illustration below. Also consult the connecting indication for 'SUBWOOFER' printed on the rear panel.
- 3) Set the OPERATING MODE Selector to 3 CHANNEL position. LED indicators above LEFT/FRONT, RIGHT/FRONT and LEFT/REAR volume controls on the front panel (3) will be illuminated. This means that the CH. 3 subwoofer is driven by the input signal coming via LEFT/REAR input connector. So, the INPUTS connectors (2) to be used for this connection are FRONT R, L and REAR L.

- 4) Press the Speaker System selector FRONT A and REAR A (front panel 6).
- 5) For displaying the level of the 2 channel stereo speaker system, set the POWER DISPLAY Switching button (5) to FRONT position. For displaying the level of CH. 3 subwoofer, set the button to REAR position.

NOTE: When displaying the level of CH. 3, the move of the DISPLAY is completely the same for both channels. Multiply the indicated value on either channel by four to know the actual peak power of CH. 3.

When driving another 3 CHANNEL system, use the lower B speaker terminals for System B, and connect the cables referring to step 1). To drive System B, press the Speaker System Selector FRONT B and REAR B (front panel 6). To drive both systems simultaneously, press all the Speaker System Selector switches.

•CONNECTIONS USING dbx 120X-DS SUB-HARMONIC SYNTHESIZER AND dbx CX-3.

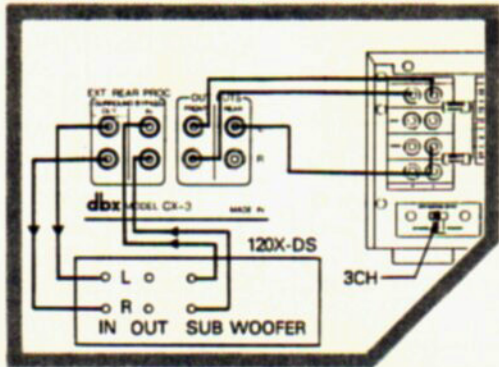

•CONNECTIONS USING X'OVER UNIT FOR CH3.

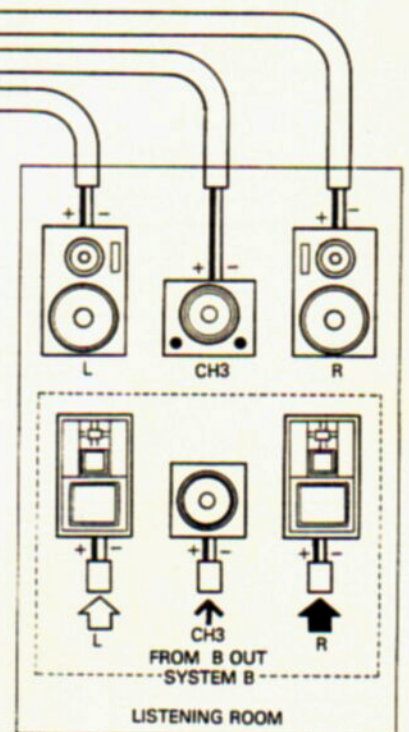
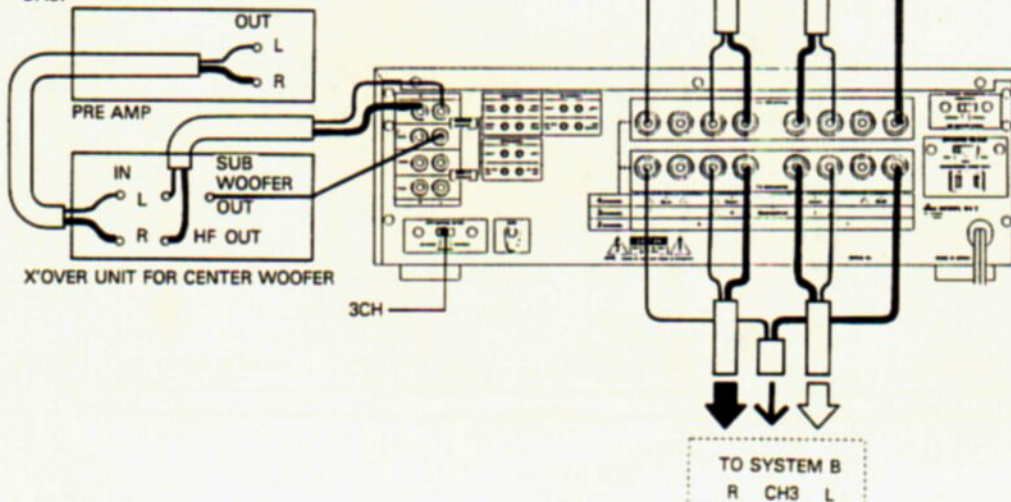

CAUTION: In this connection, since the rear channels of the CX-3 are used for controlling a sub-woofer, surround mode is deactivated. Press the SURROUND BYPASS switch on the front panel of the CX-3.

III 4 CHANNEL MODE CONNECTION

i 4 CHANNEL SYSTEM USING FRONT and REAR SPEAKER SYSTEMS

The four monaural amplifiers incorporated in the BX-2 can be operated independently to drive the FRONT speaker together with the REAR speaker system for surround application. Perform the connections in the following procedures.

- 1) First set up the FRONT speaker system. Using the FRONT R, L of the upper A speaker terminals, connect the speaker cables as shown in the illustration below, checking the polarity (+ to + and - to -).
- 2) Then set up the REAR speaker system. Using the REAR R, L of the upper A speaker terminals, connect the speaker cables as shown in the Figure below, checking the polarity (+ to + and - to -).
- 3) Set the OPERATING MODE Selector to 4 CHANNEL position. LED indicators above all the volume controls on the front panel (3) will be illuminated.

- 4) Press the Speaker System Selector FRONT A and REAR A (front panel 6).
- 5) For displaying the level of the FRONT speaker system, set the POWER DISPLAY Switching button (front panel 5) to FRONT position, and for displaying the level of the REAR speaker system, set the button to REAR position.

NOTE: All of the INPUTS connectors are used for this connection.

When driving another 4 channel system as System B, use the lower B speaker terminals and connect the speaker cables referring to step 2) and 2).

To drive System B, press the Speaker System Selector FRONT B and REAR B (front panel 6).

If the System B speakers are connected, up to four combinations of FRONT/REAR speaker systems will be available in accordance with the Speaker System Selector settings. To drive both systems simultaneously, press all the Speaker System Selector switches.

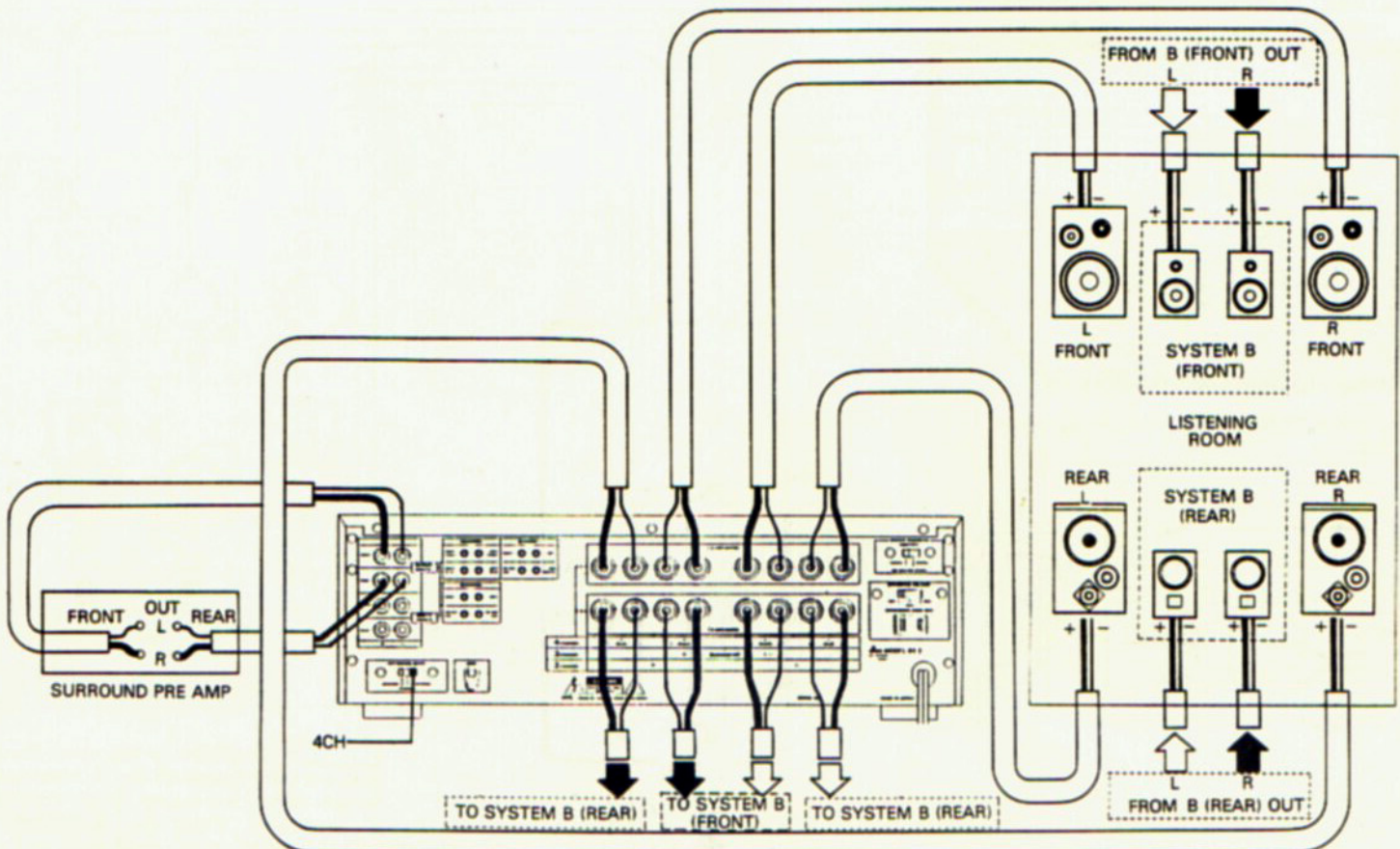

ii CONNECTION FOR DUAL 2 CHANNEL SYSTEM

2 channel stereo speaker systems can be driven by using the two of the four amplifiers incorporated in the BX-2. Perform connections as follows.

- 1) Connect the speaker cables as shown in the illustration below, checking the polarity (+ to + and - to -).
- 2) Set the OPERATING MODE Selector to 4 CHANNEL position. LED indicators above all the volume controls on the front panel (3) will become illuminated. Press the Speaker System Selector FRONT A (front panel 6).

- 3) For displaying the level of the system which is currently used, set the POWER DISPLAY Switching button to FRONT position.

NOTE: The INPUTS connectors (1 or 2) to be used for this connection are FRONT R, L only, and the REAR R, L are left unused. As it is unnecessary therefore to use the input volumes for REAR R, L, keep them turned fully counterclockwise.

Nevertheless, if an another pre amplifier is connected to the REAR inputs to drive another speaker system, different source programs can be reproduced in the different listening room, as shown in the illustration below.

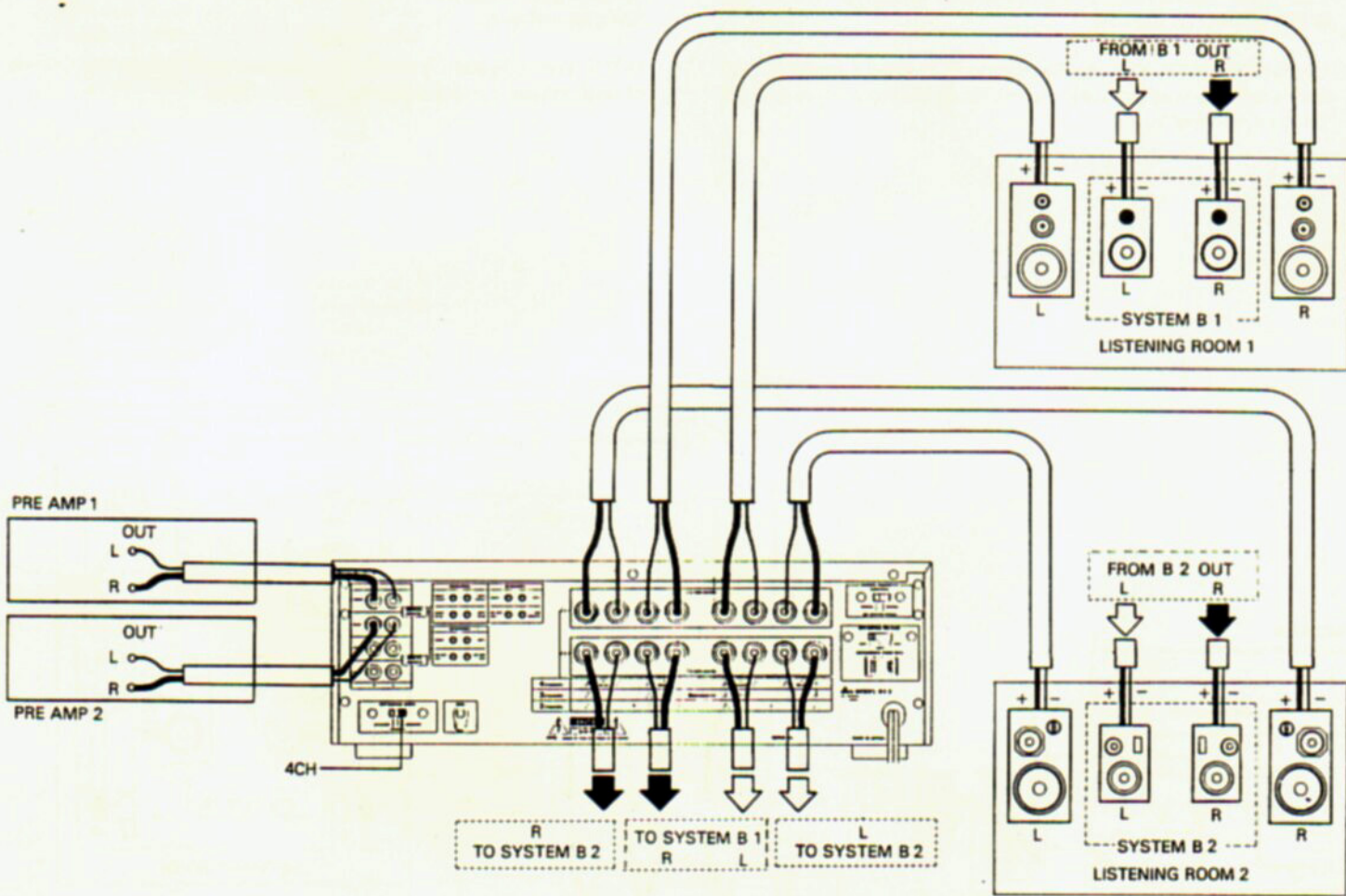

iii CONNECTION FOR 2CH 2-WAY (BI-AMP) OPERATION

The four monaural amplifiers incorporated in the BX-2 can be used to drive independently the High Frequency Units with 2 amplifiers and the Low Frequency Unit with the other two amplifiers. Connections for such Bi-Amp. operation is performed as follows.

- 1) To set up the Low Frequency Units, connect the speaker cables as shown in the illustration below, checking the polarity (+ to + and - to -).
- 2) To set up the High Frequency Units, connect the speaker cables as shown in the illustration below, checking the polarity (+ to + and - to -).
- 3) Connect an electronic crossover unit between the pre amplifier and the BX-2. With the pin plug cables, connect from the Low Frequency LINE OUT connectors of the electronic crossover unit to the B-200's INPUTS (FRONT), and from the High Frequency LINE OUT connectors of the electronic crossover unit to the B-200's INPUTS (REAR).
- 4) Set the OPERATING MODE Selector to 4 CHANNEL position. LED indicators above all the volume controls on the front panel (3) will become illuminated.

- 5) Press the Speaker System Selector FRONT A and REAR A (front panel 6).
- 6) The output level of the right Low Frequency Unit can be controlled by the RIGHT/FRONT Input Volume Control, and the left Low Frequency Unit by the LEFT/FRONT Input Volume Control. The output level of the right High Frequency Unit can be controlled by the RIGHT/REAR Input Volume Control, and the left High Frequency Unit by the LEFT/REAR Input Volume Control.
- 7) For displaying the level of the Low Frequency Units, set the POWER DISPLAY Switching button to FRONT position, and for displaying the level of the High Frequency Units, set the button to REAR position.

When driving another system in Bi-Amp. operation, use the lower B speaker connectors for System B and connect the speaker cables referring to step 1) and 2).

To drive System B, press the Speaker System Selector FRONT B and REAR B.

To drive both systems simultaneously, press all the Speaker System Selector switches.

NOTE: When System A and B are driven simultaneously, the volume of both system cannot be controlled separately.

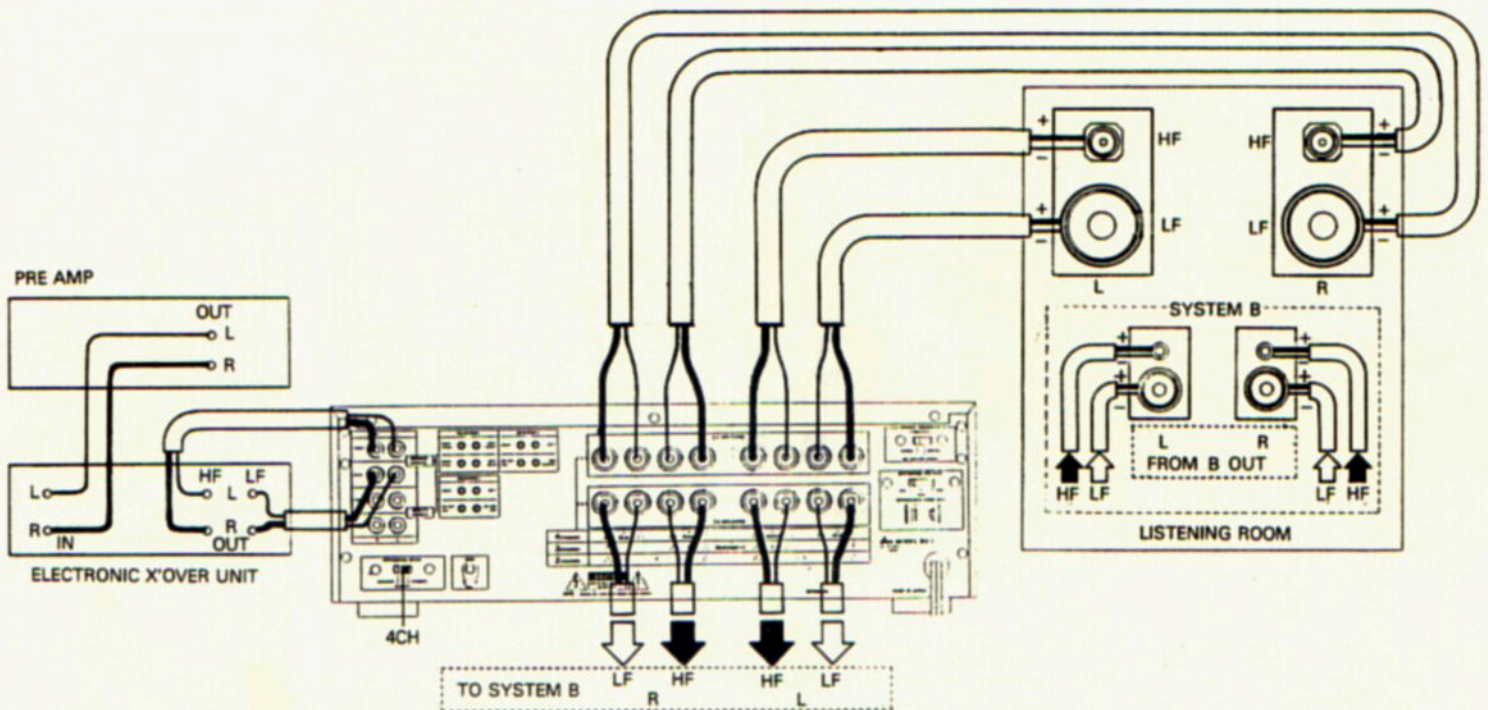

SPECIFICATIONS

SPECIFICATIONS

Power Output (RMS, 20Hz — 20kHz)

4 Channel Driven	90W x 4 (8 ohms load, 0.009% THD, SPECIAL*) 125W x 4 (4 ohms load, 0.02% THD, NORMAL*)
3 Channel Driven	80W x 2 (8 ohms load, 0.009% THD, NORMAL*) 250W x 1 (8 ohms load, 0.02% THD, NORMAL*)
2 Channel Driven	250W x 2 (8 ohms load, 0.02% THD, NORMAL*)

* Setting position of POWER TRANSFER CONTROL.

Power Output (Dynamic, IHF A-202)

Single Channel	155W/ch. (8 ohms load) 250W/ch. (4 ohms load)
Bridged Channel	500W/ch. (8 ohms load) 400W/ch. (4 ohms load)

Load Impedance

4 Channel Mode	2 to 16 ohms
2 Channel Mode	4 to 16 ohms

Total Harmonic Distortion

(20 — 20kHz/90W/8 ohms load, 4 Channel Driven)
0.009%

Frequency Response (1W/8 ohms load)

5Hz — 200kHz, +0/ -3dB
20Hz — 20kHz +0/ -1dB

Input Sensitivity

4 Channel Mode	1.2V
2 Channel Mode	0.9V

Input Impedance

20k ohms

Damping Factor (1kHz)

More than 50

Signal to Noise Ratio

115dB

Channel Separation

90dB (1kHz, 8 ohms)

Power Requirement

580W

Dimensions

17-1/2"(W) x 5-5/8"(H) x 16-3/4"(D)

Weight

40-1/8 lbs.

Specifications are subject to change without notice.

"dbx" is a registered trademark of dbx, Newton, Mass. USA, a division of BSR North America Ltd.

60-90 RAYMOND ELECTRONICS SERVICE
5462 BUCHANAN PLACE
FREMONT CA

94538

510 ^{SUNNY}
(~~415~~) 490 1622

~~1 (800) 842-5422~~

~~964 4676~~

BSR (JAPAN) LIMITED
No. 7 Azuma Bldg., 1-9 Kanda Sakuma-cho, Chiyoda-ku, Tokyo 101
Tel: 03-251-8141, TLX: BSR JAPAN J25416, FAX: 03-257-0879 (GII/GIII)

dbx^{dbx}
71 Chapel Street, Newton
Massachusetts 02195
A BSR COMPANY (617) 964-3210

87-9 Printed in Japan